

AUGUST 1984 / \$2.50

# ham radio

magazine

BUILD A 10 TO 160-METER  
LINEAR AMPLIFIER  
WITH EIMAC'S NEW 3CX800A7'S

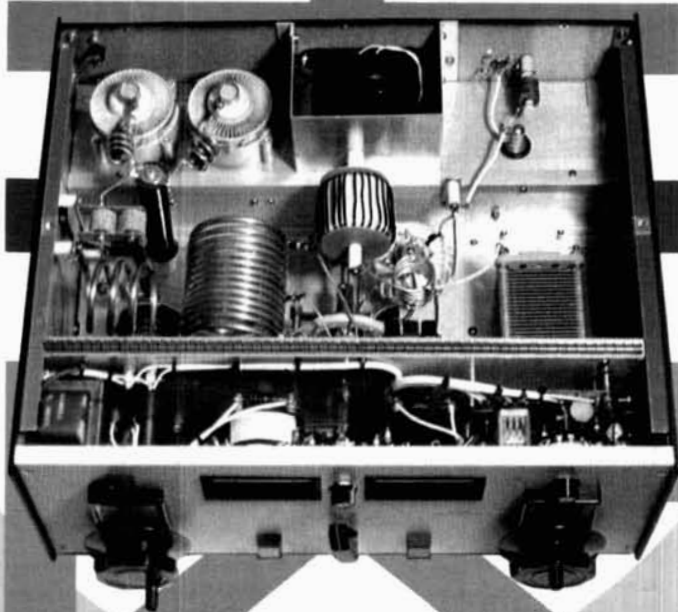

**hr**  
focus  
on  
communications  
technology

**SUMMER SPECIAL — CONSTRUCTION:** junk-box ingenuity • building better boxes • improving ALC • make your own air-wound coils • cooling semiconductors • **ALSO:** using grayline — with or without computer • a 50 MHz Tilton/Greenblum Yagi • W1JR on filters • W6SAI's ham radio techniques

# ICOM IC-27H

## Ultra Compact 45 Watt, 2-Meter Mobile!

Now ICOM offers the best choices in compact 2-meter FM mobiles...the IC-27H 45-watt compact (1 1/8" H x 5 1/2" W x 9 3/8" D) and the IC-27A 25-watt super compact mobile. The IC-27A and IC-27H are the smallest full-featured 2-meter mobile transceivers available, and feature an internal speaker for easy installation. For the ultimate portable station, the IC-37A 220MHz and IC-47A 440MHz 25 watt compact mobiles are also available.



Internal Speaker

**45 Watts.** The IC-27H provides 45 watts of output power, while the IC-27A provides 25 watts of output power.



**32 PL Frequencies.** The IC-27A and IC-27H come complete with 32 PL frequencies ready to go and are controlled from the front panel knob. Each PL frequency may be selected by the main tuning knob and stored into memory for easy access along with frequency and offset.

**9 Memories.** The IC-27A and IC-27H have nine memories avail-

able to store receive frequency, transmit offset, offset direction, and PL tone. Memories are backed up by a lithium backup battery, which will store memories for up to seven years.

**Speech Synthesizer.** As an added plus, the IC-27A/H features an optional speech synthesizer to verbally announce the receiver frequency of the transceiver through the simple touch of a button.

**Scanning.** Included with the IC-27A/H is a scanning system which allows scanning of the entire band.

IC-HM23  
Scanning mic  
with DTMF pad

**Priority Scan.** Priority may be selected to be either a memory channel or a VFO channel. By using sampling techniques, the operator can determine if a frequency of interest is free or busy.

See the IC-27A/H compact mobile transceivers at your local ICOM dealer. For superb performance, reliability, and the ultimate in a VHF mobile radio, your only choice is an ICOM.



The IC-25A 2-meter 25-watt mobile and its 45-watt companion, the IC-25H, are also available.



IC-27H  
45 Watts  
1 1/8" H x 5 1/2" W x 9 3/8" D



IC-27A  
25 Watts  
1 1/8" H x 5 1/2" W x 7" D

Also Available: IC-37A 220MHz  
and IC-47A 440MHz Compact Mobiles

 **ICOM**  
The World System

ICOM America, Inc., 2112-116th Ave NE, Bellevue, WA 98004 / 3331 Towerwood Drive, Suite 307, Dallas, TX 75241  
All stated specifications are approximate and subject to change without notice or obligation. All ICOM radios exceed FCC regulations limiting spurious emissions. 27H

## What To Look For In A Home Patch

The best way to decide what patch is right for you is to first decide what a patch should do. A patch should:

Give complete control to the mobile, allowing full break in operation.

Not interfere with the normal operation of your base station. It should not require you to connect and disconnect cables (or flip switches!) every time you wish to use your radio as a normal base station.

Not depend on volume or squelch settings of your radio. It should work the same regardless of what you do with these controls.

You should be able to hear your base station speaker with the patch installed. Remember, you have a base station because there are mobiles. **ONE OF THEM MIGHT NEED HELP.**

The patch should have standard features at no extra cost. These should include programmable toll restrict (dip switches), tone or rotary dialing, programmable patch and activity timers, and front panel indicators of channel and patch status.

**ONLY SMART PATCH HAS ALL OF THE ABOVE.**

## Low Mobile Operators Can Enjoy An Affordable Personal Phone Patch...

Without an expensive repeater.

Using any FM transceiver as a base station.

The secret is a SIMPLEX autopatch, The **SMART PATCH**.

## SMART PATCH is Easy To Install

To install **SMART PATCH**, connect the multicolored computer style ribbon cable to mic audio, receiver discriminator, PTT, and power. A modular phone cord is provided for connection to your phone system. Sound simple? ... YES!

# With SMART PATCH You are in CONTROL

With **CES 510SA Simplex Autopatch**, there's no waiting for VOX circuits to drop. Simply key your transmitter to take control.

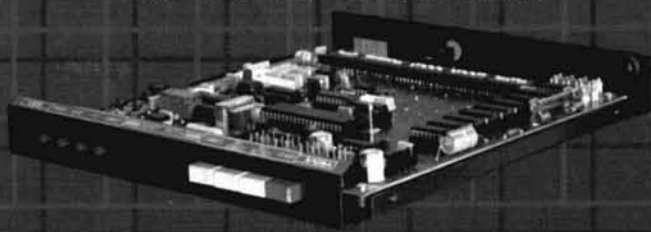

**SMART PATCH** is all you need to turn your base station into a personal autopatch. **SMART PATCH** uses the only operating system that gives the mobile complete control. Full break-in capability allows the mobile user to actually interrupt the telephone party. **SMART PATCH** does not interfere with the normal use of your base station. **SMART PATCH** works well with any FM transceiver and provides switch selectable tone or rotary dialing, toll restrict, programmable control codes, CW ID and much more.

**To Take CONTROL with Smart Patch - Call 800-327-9956 Ext. 101 today.**

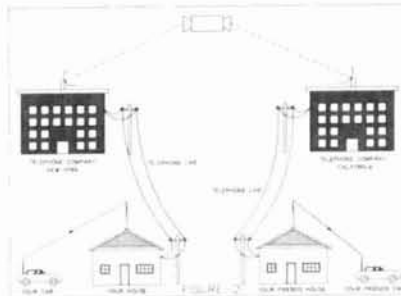
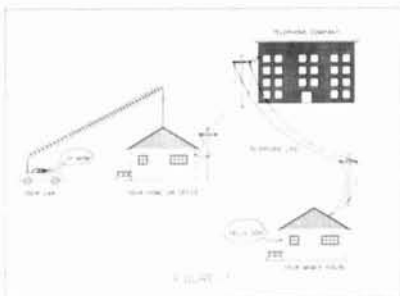

## How To Use SMART PATCH

Placing a call is simple. Send your access code from your mobile (example: \*73). This brings up the Patch and you will hear dial tone transmitted from your base station. Since **SMART PATCH** is checking about once per second to see if you want to dial, all you have to do is key your transmitter, then dial the phone number. You will now hear the phone ring and someone answer. Since the enhanced control system of **SMART PATCH** is constantly checking to see if you wish to talk, you need to simply key your transmitter and then talk. That's right, you simply key your transmitter to interrupt the phone line. The base station automatically stops transmitting after you key your mic. **SMART PATCH** does not require any special tone equipment to control your base station. It samples very high frequency noise present at your receivers discriminator to determine if a mobile is present. No words or syllables are ever lost.

## SMART PATCH Is All You Need To Automatically Patch Your Base Station To Your Phone Line.

Use **SMART PATCH** for:

- Mobile (or remote base) to phone line via Simplex base. (see fig. 1.)
- Mobile to Mobile via interconnected base stations for extended range. (see fig. 2.)
- Telephone line to mobile (or remote base).
- **SMART PATCH** uses **SIMPLEX BASE STATION EQUIPMENT**. Use your ordinary base station. **SMART PATCH** does this without interfering with the normal use of your radio.

## WARRANTY?

YES, 180 days of warranty protection. You simply can't go wrong. An FCC type accepted coupler is available for **SMART PATCH**.



**Communications Electronics Specialties, Inc.**  
P.O. Box 2930, Winter Park, Florida 32790  
Telephone: (305) 645-0474 Or call toll-free (800)327-9956



# KENWOOD

...pacesetter in amateur radio

## Scan the World. R-2000

Kenwood's R-2000 receiver has opened the doors to a new world in the 150-kHz to 30-MHz HF bands, with microprocessor controlled operating features and an UP conversion PLL circuit for maximum flexibility and to enhance the excitement of listening to stations from east to west, and from pole to pole. An optional VC-10 VHF converter, for 118 to 174-MHz, allows access to police, aviation, marine, commercial, and two meter Amateur frequencies. With dual digital VFO's, ten memories that store frequency, band and mode information, memory scan, program-mable band scan, fluorescent tube digital display, and dual 24-hour clock with timer, this outstanding radio has the versatility needed to reach out and catch those distant and elusive stations in the most remote areas of the world.

The R-2000 receives in the USB, LSB, CW, AM, and FM modes, and its ten memories allow moving from band to band without concern for mode of operation. The program-mable band scan feature permits scanning over operator selected

limits, reducing scan cycle time. Memory scan allows the operator to scan all, or only specific memories. Lithium battery memory backup (Estimated 5 year life) is built-in.

With the sensitive R-2000, only the best in selectivity will do. It has three built-in IF filters, with NARROW/WIDE selector switch, and an optional 500-Hz narrow CW filter is available. A noise blanker, and an all-mode squelch circuit further enhance the operators control of his listening environment. An AGC switch, and an RF attenuator switch allow selection of the best signal-to-noise ratio. It has a large, front mounted speaker, a tone control, an "S" meter, high and low impedance antenna terminals, and operates on 100/120/220/240 VAC, or on 13.8 VDC, with an optional DCK-1 DC cable kit. Other features include a record output jack, an audible "beeper," a carrying handle, a headphone jack, and an external speaker jack.

The R-2000 places the world at your finger tips.

**R-2000 optional accessories:**  
VC-10 VHF converter • HS-4, HS-5, and HS-6 headphones • DCK-1 DC cable kit • YG-455C 500-Hz CW filter.



**R-1000** High performance receiver.  
• 200 kHz - 30 MHz • digital display/clock/timer • 3 IF filters • PLL UP conversion • noise blanker • RF step attenuator • 120-240 VAC (Optional 13.8 VDC).



**R-600** General coverage receiver.  
• 150 kHz - 30 MHz • digital display  
• 2 IF filters • PLL UP conversion • noise blanker • RF attenuator • front speaker  
• 100-240 VAC (Optional 13.8 VDC).

More information on these products is available from authorized dealers of Trio-Kenwood Communications, 1111 West Walnut Street, Compton, California 90220.

*Specifications and prices are subject to change without notice or obligation.*





# SAVE \$10.00\* with home delivery

\*(One year newsstand cost \$30.00)

Here's my address label, enter my subscription.  Payment enclosed  
 Bill me later

1 Year . . . . . 12 issues . . . . . \$19.95  
2 Years . . . . . 24 issues . . . . . \$32.95  
3 Years . . . . . 36 issues . . . . . \$44.95 U. S. prices only

Name \_\_\_\_\_ State \_\_\_\_\_ Zip \_\_\_\_\_

Address \_\_\_\_\_ (attach label)

City \_\_\_\_\_

Check here if this is your renewal (attach label)

## Subscribe to **ham radio** MAGAZINE

Please allow 4-6 weeks for delivery of first issues.

**Foreign rates:** Europe, Japan and Africa, \$28.00 for one year by air forwarding service. All other countries \$22.95 for one year by surface mail.

Please  
enter my  
subscription



**BUSINESS REPLY CARD**

First Class    Permit No. 1    Greenville, NH

Postage Will Be Paid By Addressee

NO POSTAGE  
NECESSARY  
IF MAILED  
IN THE  
UNITED STATES



**ham  
radio**  
Greenville, NH 03048

# ham radio

magazine

**AUGUST 1984**

volume 17, number 8

**T. H. Tenney, Jr., W1NLB**  
publisher

**Rich Rosen, K2RR**  
editor-in-chief  
and associate publisher

**Dorothy Rosa, KA1LBO**  
assistant editor

Joseph J. Schroeder, W9JUV  
associate editor  
Susan Shorrock  
editorial production

**editorial review board**

Forrest Gehrke, K2BT  
Bob Lewis, W2EBS  
Mason Logan, K4MT  
Ed Wetherhold, W3NQN

**publishing staff**

**J. Craig Clark, Jr., N1ACH**  
assistant publisher

**Rally Dennis, KA1JWF**  
director of advertising sales

Dorothy Sargent, KA1ZK  
advertising production manager

Susan Shorrock  
circulation manager

Therese Bourgault  
circulation

Wayne Pierce, K3SUK  
cover art

ham radio magazine is published by  
Communications Technology, Inc.  
Greenville, New Hampshire 03048-0498  
Telephone: 603-878-1441

**subscription rates**

United States:  
one year, \$19.95; two years, \$32.95; three years, \$44.95  
Canada and other countries (via surface mail):  
one year, \$22.95; two years, \$41.00; three years, \$58.00  
Europe, Japan, Africa (via Air Forwarding Service): one year, \$28.00  
All subscription orders payable in U.S. funds, via international  
postal money order or check drawn on U.S. bank

**international subscription agents:** page 136

Microfilm copies are available from  
University Microfilms, International  
Ann Arbor, Michigan 48106  
Order publication number 3076

Cassette tapes of selected articles from *ham radio*  
are available to the blind and physically handicapped  
from Recorded Periodicals,  
919 Walnut Street, Philadelphia, Pennsylvania 19107

Copyright 1984 by Communications Technology, Inc.  
Title registered at U.S. Patent Office

Second-class postage paid  
at Greenville, New Hampshire 03048-0498  
and at additional mailing offices  
ISSN 0148-5989

Postmaster send form 3579 to *ham radio*  
Greenville, New Hampshire 03048-0498



## contents

**17 a 3CX800A7 linear amplifier**

Jerry L. Pittenger, K8RA

**32 junk-box ingenuity: how to buy, use,  
and recycle surplus electronic parts**

Bob Lombardi, WB4EHS

**37 constructing air-wound coils**

Paul A. Johnson, W7KBE

**40 improving amplifier ALC circuits:  
part 1**

J. Fred Riley, WA8AJN

**45 build a better box**

Michael Gruchalla

**52 cooling semiconductors  
part 2: blowers and fans**

Vaughn D. Martin

**77 fundamentals of grayline propagation**

Bradley Wells, KR7L

**81 DXing by computer**

Van Brollini, NS6N, and Walter Buchanan

**96 ham radio techniques**

Bill Orr, W6SAI

**103 applied Yagi design  
part 4: a 50 MHz Tilton/Greenblum  
design**

Stanley Jaffin, WB3BGU

**112 VHF/UHF world**

Joe Reisert, W1JR

**140 advertisers index and reader service**      **122 new products**  
**10 presstop**

**63 DX forecaster**      **6 reflections**

**136 flea market**      **119 short circuit**

**134 ham mart**





Mason Logan, K4MT

# REFLECTIONS

... with a little help  
from our friends



Forrest Gehrke, K2BT

**We hate to admit it**, but we don't know everything there is to know about Amateur Radio. What's more, the field is so vast, and expanding so quickly, that we can't even *hope* to know it all. We try — but there are times when our individual and collective wisdom fails and we have to turn to others for help. Perhaps the subject at hand is an idea so new that we need to learn more about it ourselves. Or perhaps all we need is confirmation of our opinion that an idea may be unworkable because of some flaw in the concept or method proposed.

When we need a knowledgeable friend to turn to — to review a questionable manuscript, or to clarify, confirm, or correct some detail or theory or practice — we turn to one of the four distinguished members of *ham radio's* editorial board. We look to them for two things: first, for their expertise in their specific areas of knowledge and experience; and second, for their unique perspective on Amateur Radio. Spanning the past and present, with an eye on the future of Amateur Radio, these gentlemen give us a perspective that's easy to lose sight of in the day-to-day business of making sure your copy of *ham radio* arrives each month.

While we'd like to introduce each one of the members of our editorial board to you personally, that's obviously impossible. So we'll do the next best thing and introduce them to you in print.

**Ed Wetherhold, W3NQN**, first encountered Amateur Radio in 1947 while in training as an Air Force radio technician. A buddy in the barracks had set up a station next to his bunk. Ed was "hooked." He went on to study Radio Engineering at Tri-State University in Angola, Indiana, and graduated in 1956. Since 1962 he's been with Honeywell in Annapolis, Maryland, where he's responsible for testing communications systems. In addition, he distributes surplus 44- and 88-mH toroidal inductors in the United States and in the U.K. to facilitate easy assembly of his filter designs, and writes extensively in the international Amateur press. Ed also serves as technical advisor to the ARRL in the area of his specific interest, passive LC filters.

While Ed found Amateur Radio, Amateur Radio "found" **Forrest Gehrke, K2BT**. At 10, he was building one-tube regenerative broadcast band receivers, using UV-199's and 201A's. One day he inadvertently omitted some turns around the oatmeal box, and some fascinating activity on the 160-meter band spilled into his earphones. First licensed as W9WJD in 1936, Forrest says he was "bitten by the DX bug shortly afterward when, during sunspot peak openings, you could work the world on 10 meters with no discernible power output." He earned an E.E. degree from the University of Wisconsin and spent 30 years trying to "push the state of the art" in electron tubes. By the early 1960's, he was working in the development of a 10 GHz solid-state power source for the MoonLander's retro-rocket landing control radar. He now works in the data communications industry, developing packet networks that communicate at 56K bits per second.

World War II, marriage, and sharing in the raising of eight children caused what K2BT calls "slight intermission" in Amateur Radio activities until 1968, when he resumed the push for DXCC he'd begun in 1939. He reached 5BDXCC in 1974, Honor Roll in 1978, and is currently aiming for Honor Roll Status solely in the 80-meter band. His special interest: antennas.

**Mason Logan, K4MT**, studied physics at CalTech and Columbia and worked with Bell Telephone Laboratories for 50 years. His early work was in telephone transmission and signalling research; later he designed circuits for underwater acoustic and magnetic proximity fuzes, high-loop gain negative feedback amplifiers, and servomechanism circuits for the development model of the NIKE-guided missile analog computer.

Now and then a problem will come along that demands a theoretical solution. If it pertains to any aspect of electromagnetics, we turn to **Bob Lewis, W2EBS**. Bob started out in Amateur Radio in 1921 (as did K4MT) when he was a 13-year old Boy Scout leafing through the pages of his handbook in search of another merit badge to win. The "Wireless" badge caught his eye and he ran to the store for some oatmeal — not for the cereal, or course, but for the box that it came in. Finally licensed in the early 1930's, he attended Virginia Military Institute and graduated from the University of Pennsylvania. Graduate study — including an M.B.A. — followed.

Bob worked in research at RCA from 1932 through 1939, when he left to join the research team at CBS. (While at RCA, incidentally, he worked in the design of the television transmitting antennas atop the Chrysler Building in New York City.) He served overseas during World War II, working in radar countermeasures, with the office of Scientific Research and Development. After the war he returned to CBS and then went to Federal Telegraph and Radio. After ITT bought Federal, he joined the ITT research group in Nutley, New Jersey. He joined a small group of friends and colleagues in Prodelin, Inc., and spent the following 20+ years, until retirement, working in the development of transmission lines and antennas.

Over the coming months we'll be looking to expand the editorial review board to include others of similar standing, but with different areas of expertise. If you have an area of special interest and achievement in Amateur Radio — and aren't too modest to admit it — get in touch with us. You don't have to be one of the Founding Fathers of Amateur Radio; if you "know your stuff," and want to play a meaningful role in the production of a high-quality technical publication, let us know. *We'd like to know you.*

Dorothy Rosa, KA1LBO  
Assistant Editor

# FREE MFJ SOFTWARE

Free MFJ RTTY/ASCII/CW software for VIC-20 or C-64 with purchase of MFJ-1224, MFJ-1225 or MFJ-1228 from MFJ. Send/receive Baudot, ASCII, CW. Type ahead buffer. 24 hour clock. Supports VIC printer. Menu Driven. MFJ-1224/1225 cable. On tape. Available separately for \$29.95.

## RTTY/ASCII/ AMTOR/CW INTERFACE CARTRIDGE FOR VIC-20/C-64



MFJ-1228 \$69.95

**FREE MFJ RTTY/ASCII/CW Software**  
INCLUDES MFJ-1228, SOFTWARE ON TAPE. ADD  
VIC-20 OR C-64 AND RIG TO ENJOY COMPUTER-  
IZED RTTY/ASCII/CW. ORDER MFJ-1228/MFJ-  
1264 FOR VIC-20, MFJ-1228/MFJ-1265 FOR C-64.

Most versatile RTTY/ ASCII/AMTOR/CW inter-  
face cartridge available for VIC-20 and Commodore  
64. Gives you more features, more performance,  
more value for your money than any other interface  
cartridge available.

Same interface cartridge works for both VIC-20 and  
Commodore 64. Plugs into user's port.

Choose from wide variety of RTTY/ASCII/CW,  
even AMTOR software. Not married to one on-board  
software package. Use MFJ, Kantronics, AEA plus  
other software cartridge, tape or disk.

850 Hz and 170 Hz shifts on receive and transmit.  
Has mark and space outputs for scope tuning.

Normal/Reverse switch eliminates retuning.  
True dual channel mark and space active filters and  
automatic threshold correction gives good copy when  
one tone is obliterated by QRM or selective fading.

Easy, positive tuning with twin LED indicators.  
Narrow 800 Hz active CW filter. Automatic PTT.

Exar 2206 sine generator for AFSK output.  
Shielded XCVR AFSK/PTT interface cable provid-  
ed. Plus or minus CW keyed output. FSK out.

Powered by computer (few ma.), no power adapter  
to buy or extra wire to dangle or pick up/radiate RFI.

Glass epoxy PCB. Aluminum enclosure. 4 1/2 x 4 1/2 x 1 1/2".

## UNIVERSAL SWL RECEIVE ONLY COMPUTER INTERFACE FOR RTTY/ASCII/AMTOR/CW

MFJ-1225  
\$69.95



**FREE MFJ RTTY/ASCII/CW Software**

TAPE AND CABLE FOR VIC-20 OR C-64. ORDER MFJ-1225/  
MFJ-1264 FOR VIC-20 OR MFJ-1225/MFJ-1265 FOR C-64.

Use your personal computer and communications  
receiver to receive commercial, military and amateur  
RTTY/ASCII/AMTOR/CW traffic.

Plugs between receiver and VIC-20, Apple, TRS-  
80C, Atari, TI-99, Commodore 64 and most other  
personal computers. Requires appropriate software.

Use MFJ, Kantronics, AEA and other RTTY/  
ASCII/AMTOR/CW software.

Copies all shifts and all speeds. Twin LED indicators  
makes tuning easy, positive. Normal/Reverse switch  
eliminates tuning for inverted RTTY. Speaker out  
jack. Includes cable to interface MFJ-1224 to VIC-20

ORDER ANY PRODUCT FROM MFJ AND TRY IT-NO  
OBLIGATION. IF NOT DELIGHTED, RETURN WITH-  
IN 30 DAYS FOR PROMPT REFUND (LESS SHIPPING).

- One year unconditional guarantee • Made in USA.
- Add \$4.00 each shipping/handling • Call or write  
for free catalog, over 100 products.

## UNIVERSAL RTTY/ASCII/AMTOR/ CW COMPUTER INTERFACE

Lets you send and receive computerized RTTY/ASCII/AMTOR/CW. Copies  
all shifts and all speeds. Copies on both mark and space. Sharp 8 pole active  
filter for 170 Hz shift and CW. Plugs between your rig and VIC-20, Apple,  
TRS-80C, Atari, TI-99, Commodore 64 or other personal computers. Uses  
MFJ, Kantronics, AEA software and other RTTY/CW software.

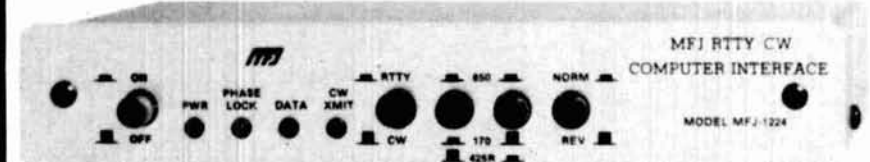

**FREE MFJ RTTY/ASCII/CW Software**  
COMPLETE PACKAGE INCLUDES MFJ-1224, SOFTWARE ON TAPE,  
CABLES. YOU NEED ONLY VIC-20 OR C-64 AND RIG TO ENJOY COM-  
PUTERIZED RTTY/ASCII/CW. ORDER MFJ-1224/MFJ-1264 FOR VIC-20,  
MFJ-1224/MFJ-1265 FOR C-64.

MFJ-1224  
\$99.95

New MFJ-1224 RTTY/ASCII/AMTOR/CW Com-  
puter Interface lets you use your personal computer  
as a computerized full featured RTTY/ASCII/  
AMTOR/CW station for sending and receiving. Plugs  
between rig and VIC-20, Apple, TRS-80C, Atari,  
TI-99, Commodore 64 and most others.

Use MFJ software for VIC-20, Commodore 64 and  
Kantronics for Apple, TRS-80C, Atari, TI-99 and  
most other software for RTTY/ASCII/AMTOR/CW.

Easy, positive tuning with twin LED indicators.  
Copy any shift (170, 425, 850 Hz and all other shifts)  
and any speed (5-100 WPM RTTY/CW and up to 300  
baud ASCII).

Copies on both mark and space, not mark only or  
space only, to improve copy under adverse conditions.

Sharp 8 pole 170 Hz shift/CW active filter gives  
good copy under crowded, fading and weak signal  
conditions. Automatic noise limiter suppress static  
crashes for better copy.

Normal/Reverse switch eliminates retuning. +250  
VDC loop output drives RTTY machine. Speaker jack.

Automatic tracking copies drifting signal.  
Exar 2206 sine generator gives phase continuous  
AFSK tones. Standard 2125 Hz mark and 2295/2975  
Hz space. Microphone line: AFSK out, AFSK ground,  
PTT out and PTT ground.

FSK keying output. Plus and minus CW keying.  
CW transmit LED. External CW key jack.

Kantronics compatible socket.  
Exclusive general purpose socket allows interfac-  
ing to nearly any personal computer with most appro-  
priate software. Available TTL lines: RTTY demod  
out, CW demod out, CW-ID input, +5 VDC, ground.  
All signal lines are buffered and can be inverted  
using an internal DIP switch.

Use Gallo software with Apple, RAK with VIC-20,  
Kantronics with TRS-80C, TI-99, N4EU with TRS-80  
III, IV. Some computers with some software may re-  
quire some external components.

Metal cabinet. Brushed alum. front. 8x1 1/4x6 in.  
12-15 VDC or 110 VAC with adapter, MFJ-1312, \$9.95.  
MFJ-1223, \$29.95, RS-232 adapter for MFJ-1224.

## SUPER RTTY FILTER

MFJ-725  
\$39.95



Super RTTY  
filter greatly  
improves copy under

crowded, fading and weak signal conditions. Improves  
any RTTY receiving system. 8 pole bandpass active  
filter for 170 Hz shift (2125/2295 Hz mark/space). 200  
or 400 Hz bandwidths. Automatic noise limiter. Audio  
in, speaker out jacks. On/off/bypass switch. "ON"  
LED. 12 VDC or 110 VAC with optional AC adapter,  
MFJ-1312, \$9.95. 3x4x1 inch aluminum cabinet.

or Commodore 64. 4 1/2 x 1 1/4 x 4 1/4 inches. 12-15 VDC or  
110 VAC with optional adapter, MFJ-1312, \$9.95.

## CW INTERFACE CARTRIDGE FOR VIC-20/C-64

\$39.95



MFJ-1226  
High performance CW  
interface cartridge. Gives  
excellent performance  
under weak, crowded, noisy  
conditions. Works for both VIC-20 and Commodore  
64. Plugs into user's port.

4 pole 100 Hz bandwidth active filter. 800 Hz  
center frequency. 3 pole active lowpass post detection  
filter. Exclusive automatic tracking comparator.

Plus and minus CW keying. Audio in, speaker out  
jacks. Powered by computer.

Includes Basic listing of CW transmit/receive pro-  
gram. Available on cassette tape, MFJ-1252 (VIC-20)  
or MFJ-1253 (C-64), \$4.95 and on software cartridge,  
MFJ-1254 (VIC-20) or MFJ-1255 (C-64), \$19.95.

You can also use Kantronics, AEA other software.  
Also copy RTTY with single tone detection.

# MFJ

MFJ ENTERPRISES, INC.

Box 494, Mississippi State, MS 39762

TO ORDER OR FOR YOUR NEAREST  
DEALER, CALL TOLL-FREE  
800-647-1800. Call 601-323-5869  
in Miss. and outside continental USA  
Telex 53-4590 MFJ STKV



# THE MOST AFFORDABLE REPEATER

## ALSO HAS THE MOST IMPRESSIVE PERFORMANCE FEATURES

(AND GIVES THEM TO YOU AS STANDARD EQUIPMENT!)



### JUST LOOK AT THESE PRICES!

Band	Kit	Wired/Tested
10M,6M,2M,220	\$680	\$880
440	\$780	\$980

Both kit and wired units are complete with all parts, modules, hardware, and crystals.

### CALL OR WRITE FOR COMPLETE DETAILS.

Also available for remote site linking, crossband, and remote base.

### FEATURES:

- SENSITIVITY SECOND TO NONE; TYPICALLY 0.15  $\mu$ V ON VHF, 0.3  $\mu$ V ON UHF.
- SELECTIVITY THAT CAN'T BE BEAT! BOTH 8 POLE CRYSTAL FILTER & CERAMIC FILTER FOR GREATER THAN 100 dB AT  $\pm$  12KHZ. HELICAL RESONATOR FRONT ENDS. SEE R144, R220, AND R451 SPECS IN RECEIVER AD BELOW.
- OTHER GREAT RECEIVER FEATURES: FLUTTER-PROOF SQUELCH, AFC TO COMPENSATE FOR OFF-FREQ TRANSMITTERS, SEPARATE LOCAL SPEAKER AMPLIFIER & CONTROL.
- CLEAN, EASY TUNE TRANSMITTER; UP TO 20 WATTS OU (UP TO 50W WITH OPTIONAL PA).

## HIGH QUALITY MODULES FOR REPEATERS, LINKS, TELEMETRY, ETC.

### HIGH-PERFORMANCE RECEIVER MODULES

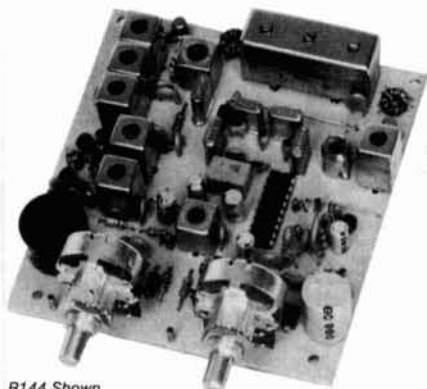

R144 Shown

- **R144/R220 FM RCVRs** for 2M or 220 MHz. 0.15 $\mu$ V sens.; 8 pole xtal filter & ceramic filter in i-f, helical resonator front end for exceptional selectivity, more than -100 dB at  $\pm$ 12 kHz, best available today. Flutter-proof squelch. AFC tracks drifting xmtrs. Xtal oven avail. Kit only \$138.
- **R451 FM RCVR** Same but for uhf. Tuned line front end, 0.3  $\mu$ V sens. Kit only \$138.
- **R76 FM RCVR** for 10M, 6M, 2M, 220, or commercial bands. As above, but w/o AFC or hel. res. Kits only \$118. Also avail w/4 pole filter, only \$98/kit.
- **R110 VHF AM RECEIVER** kit for VHF aircraft band or ham bands. Only \$98.
- **R110-259 SPACE SHUTTLE RECEIVER**, kit only \$98.

### TRANSMITTERS

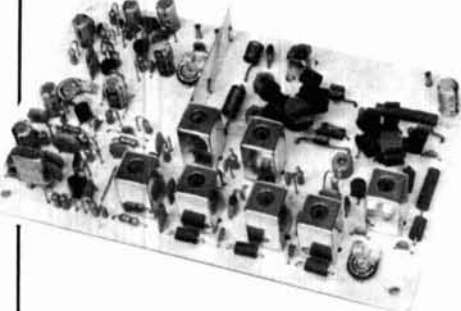

- **T51 VHF FM EXCITER** for 10M, 6M, 2M, 220 MHz or adjacent bands. 2 Watts continuous, up to 2 1/2 W intermittent. \$68/kit.



- **T451 UHF FM EXCITER** 2 to 3 Watts on 450 ham band or adjacent freq. Kit only \$78.
- **VHF & UHF LINEAR AMPLIFIERS.** Use on either FM or SSB. Power levels from 10 to 45 Watts to go with exciters & xmtg converters. Several models. Kits from \$78.
- **A16 RF TIGHT BOX** Deep drawn alum. case with tight cover and no seams. 7 x 8 x 2 inches. Designed especially for repeaters. \$20.

### ACCESSORIES

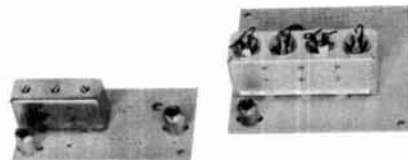

- **HELICAL RESONATOR FILTERS** available separately on pcb w/connectors.  
HRF-144 for 143-150 MHz \$38  
HRF-220 for 213-233 MHz \$38  
HRF-432 for 420-450 MHz \$48
- **COR-2 KIT** With audio mixer, local speaker amplifier, tail & time-out timers. Only \$38.
- **COR-3 KIT** as above, but with "courtesy beep". Only \$58.
- **CWID KITS** 158 bits, field programmable clean audio, rugged TTL logic. Kit only \$68
- **DTMF DECODER/CONTROLLER KITS** Control 2 separate on/off functions with touchtones<sup>®</sup>, e.g., repeater and autopatch. Use with main or aux. receiver or with Auto patch. Only \$90
- **AUTOPATCH KITS.** Provide repeater auto patch, reverse patch, phone line remote control of repeater, secondary control via repeater receiver. Many other features. Only \$90. Requires DTMF Module.
- **NEW - SIMPLEX AUTOPATCH** Use with any transceiver. System include DTMF & Autopatch modules above and new Timing module to provide simplex autopatch and reverse autopatch. Complete patch system only \$200/kit. Call or write for details

**hamtronics**<sup>®</sup>



# NEW LOW-NOISE PREAMPS RECEIVING CONVERTERS TRANSMIT CONVERTERS



**Hamtronics Breaks the Price Barrier!**



No Need to Pay \$80 to \$125 for a GaAs FET Preamp.

**FEATURES:**

- Very Low Noise: 0.7 dB VHF, 0.8 dB UHF
- High Gain: 18 to 28 dB, Depending on Freq.
- Wide Dynamic Range for Overload Resistance
- Latest Dual-gate GaAs FET, Stable Over Wide Range of Conditions
- Rugged, Diode-protected Transistors
- Easy to Tune
- Operates on Standard 12 to 14 Vdc Supply
- Can be Tower Mounted

MODEL	TUNES RANGE	PRICE
LNG-28	26-30 MHz	\$49
LNG-50	46-56 MHz	\$49
LNG-144	137-150 MHz	\$49
LNG-220	210-230 MHz	\$49
LNG-432	400-470 MHz	\$49
LNG-40	30-46 MHz	\$64
LNG-160	150-172 MHz	\$64



Models to cover every practical rf & if range to listen to SSB, FM, ATV, etc. NF = 2 dB or less.

	Antenna Input Range	Receiver Output
<b>VHF MODELS</b>	28-32	144-148
	50-52	28-30
Kit with Case \$49	50-54	144-148
Less Case \$39	144-146	28-30
Wired \$69	145-147	28-30
	144-144.4	27-27.4
	146-148	28-30
	144-148	50-54
	220-222	28-30
	220-224	144-148
	222-226	144-148
	220-224	50-54
	222-224	28-30

	Antenna Input Range	Receiver Output
<b>UHF MODELS</b>	432-434	28-30
	435-437	28-30
Kit with Case \$59	432-436	144-148
Less Case \$49	432-436	50-54
Wired \$75	439.25	61.25

**SCANNER CONVERTERS** Copy 72-76, 135-144, 240-270, 400-420, or 806-894 MHz bands on any scanner. Wired/tested Only \$88.

For SSB, CW, ATV, FM, etc. Why pay big bucks for a multi mode rig for each band? Can be linked with receive converters for transceive. 2 Watts output vhf, 1 Watt uhf.

	Exciter Input Range	Antenna Output
For VHF, Model XV2 Kit \$79 Wired \$149 (Specify band)	28-30	144-146
	28-29	145-146
	28-30	50-52
	27-27.4	144-144.4
	28-30	220-222*
	50-54	220-224
	144-146	50-52
	50-54	144-148
	144-146	28-30

	Exciter Input Range	Antenna Output
For UHF, Model XV4 Kit \$99 Wired \$169	28-30	432-434
	28-30	435-437
	50-54	432-436
	61.25	439.25
	144-148	432-436*

\*Add \$20 for 2M input



**VHF & UHF LINEAR AMPLIFIERS.** Use with above. Power levels from 10 to 45 Watts. Several models, kits from \$78.

## ECONOMY PREAMPS

Our traditional preamps, proven in years of service. Over 20,000 in use throughout the world. Tuneable over narrow range. Specify exact freq. band needed. Gain 16-20 dB. NF = 2 dB or less. VHF units available 27 to 300 MHz. UHF units available 300 to 650 MHz.

- P30K, VHF Kit less case \$18
- P30W, VHF Wired/Tested \$33
- P432K, UHF Kit less case \$21
- P432W, UHF Wired/Tested \$36

## HELICAL RESONATOR PREAMPS

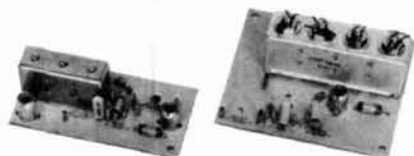

Our lab has developed a new line of low-noise receiver preamps with helical resonator filters built in. The combination of a low noise amplifier and the sharp selectivity of a 3 or 4 section helical resonator provides increased sensitivity while reducing intermod and cross-band interference in critical applications. See selectivity curves at right. Gain = approx. 12 dB.

Model	Tuning Range	Price
HRA-144	143-150 MHz	\$49
HRA-220	213-233 MHz	\$49
HRA-432	420-450 MHz	\$59
HRA-( )	150-174 MHz	\$69
HRA-( )	450-470 MHz	\$79

## SAVE A BUNDLE ON VHF FM TRANSCEIVERS!

FM-5 PC Board Kit - ONLY \$178 complete with controls, heatsink, etc. 10 Watts, 5 Channels, for 2M or 220 MHz.



Cabinet Kit, complete with speaker, knobs, connectors, hardware. Only \$60.

**REPEAT OF A SELLOUT!**

While supply lasts, get \$60 cabinet kit free when you buy an FM-5 Transceiver kit. Where else can you get a complete transceiver for only \$178

## LOOK AT THESE ATTRACTIVE CURVES!

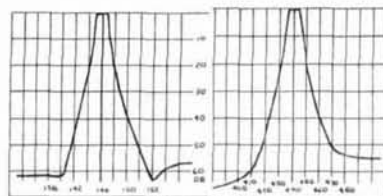

Typical Selectivity Curves of Receivers and Helical Resonators.

## IMPORTANT REASONS WHY YOU SHOULD BUY FROM THE VALUE LEADER:

1. Largest selection of vhf and uhf kits in the world.
2. Exceptional quality and low prices due to large volume.
3. Fast delivery; most kits shipped same day.
4. Complete, professional instruction manuals.
5. Prompt factory service available and free phone consultation.
6. In business 21 years.
7. Sell more repeater modules than all other mfrs. and have for years. Can give quality features for much lower cost.

- Call or Write for FREE CATALOG
- (Send \$1.00 or 4 IRC's for overseas mailing)
- Order by phone or mail • Add \$3 S & H per order (Electronic answering service evenings & weekends)
- Use VISA, MASTERCARD, Check, or UPS COD.

**hamtronics, inc.**

65-E MOUL RD. • HILTON NY 14468

Phone: 716-392-9430

Hamtronics® is a registered trademark

# presstop de W9JUV

SOME COMMERCIAL INCURSION INTO THE AMATEUR 220-225 MHZ BAND is still very possible, according to informed observers of the Washington and Land Mobile scene. Despite strong denials at high FCC levels, there's an ongoing belief in some circles that at least a portion of the band (some say as much as half!) could be reallocated to Land Mobile in the near future. If so, it would likely go for a narrowband technology such as ACSB.

A Proposal To Permit Novice Phone Operation On 220 Mhz has been submitted to the FCC by WA2MCT and WD5DON as a Petition for Rulemaking. Opposition to their proposal since it was first suggested has been very strong, both at the Dayton Hamvention 220 MHz Forum and in letters to "220 Notes," K9XI's national 220 MHz Newsletter.

In An Unrelated Move, A 224.750 MHz Experimental License has been granted to the University of Illinois' Wallops Island, Virginia, test facility "to support research in ionospheric radio propagation required by U.S. Government contract."

420-430 MHZ IS NO LONGER AVAILABLE TO U.S. AMATEURS located within 75 miles of the Canadian border. The ban results from Canada's decision several years ago to allocate the bottom 10 MHz of the 70-cm band to land mobile, and a consequent agreement between its DOC and the FCC to protect Canadian land mobile users from possible U.S. Amateur interference. Though the protection band, which actually exceeds 75 miles in some areas, has theoretically been in effect for some time, the FCC has not yet begun to actively enforce it.

Included In The Protection Band Are Such Major U.S. Cities as Seattle and Duluth, most of Michigan (including Detroit), Toledo, Cleveland, Erie, at least half of the states of New York, Vermont, and New Hampshire, and most of Maine, including Bangor! A 75-mile band of protection also extends along the Alaska-Canada border, encompassing Juneau and Ketchikan. U.S. Land Mobile Stations Using Frequencies Between 30 And 470 Mhz In The Protected Areas are also affected, but can receive clearance for licensing on a non-interfering basis. U.S. land mobile stations with an ERP under five watts do not require any Canadian coordination. However, there is no such leeway for Amateur operations along the borders.

Unusual Signals May Be Encountered In The 70-cm Band By Amateurs in much of New York, New Jersey, and Pennsylvania in coming months. Grumman Aerospace has received an FCC experimental license to operate on various frequencies between 424 and 446 MHz within a 150-mile radius of Binghamton, New York, in connection with work on the E-2C system.

A THIRD AMATEUR HAS BEEN NAMED TO BECOME AN ASTRONAUT BY NASA. Ron Parise, WA4SIR, a scientist employed by NASA at Greenbelt, Maryland, is scheduled to make his first trip on the Space Shuttle in 1986. He joins W5LFL, who conducted the first Amateur operation from space late last year, and W0ORE, who's up for his first Shuttle trip next spring.

Amateur Operation During W0ORE's Upcoming Shuttle Flight has been formally proposed by the ARRL and AMSAT. In their joint proposal the two groups stated their goal was to involve as many Amateurs as possible, particularly through school and club stations. In addition to 2-meter FM such as W5LFL used, a 10-meter downlink for 2-meter audio and SSTV pictures from the Shuttle has also been suggested. NASA's decision is expected soon.

SIMPLEX AUTOPATCHES MUST HAVE A SEPARATE CONTROL MEANS ON ANY AMATEUR BAND, not just below 220.5 MHz. Confusion arose with the ARRL Executive Committee's recent adoption of a requirement that all QST ads for simplex autopatch devices state their use is not permitted "...in the 2-meter band, or on any other frequency below 220.5 MHz..." without a separate control link. The FCC requires positive transmitter control on all Amateur frequencies—not just 2 meters—but feels the real issue is whether the simplex autopatch is really "Amateur Radio" rather than how existing rules can be bent to fit its operation.

VOLUNTEER EXAMINER COORDINATORS HAVE NOW BEEN ACCEPTED IN ALL AREAS, with the appointment of W5YI Report Editor/Publisher, Fred Maia, as a VEC for all 13 districts. The Zero District now also has a "resident" VEC, the PHD Radio Club from Missouri; until Maia's acceptance, the First District was the last still lacking a VEC.

ARRL Applied To Become A VEC In All 13 Areas June 27. In their 1-1/2 page proposal, down sharply from an earlier 70-80 page draft, the League still remained adamant that its active participation wouldn't begin until the FCC authorized collection of exam fees. However, it still looks very likely that the fee proposal will be adopted in some form before the FCC's summer recess begins August 1. The height of the "Chinese wall" between the League's publishing business and its VEC organization is still a likely problem area.

Well Over 1000 Exams Have Now Been Given Under VEC Direction, and the program seems to be working quite well in most areas. Most VECs expect to be ready to give Advanced and Extra Class exams by the end of July, and the Second District VEC, Metroplex, will be giving Novice through Extra Exams at the ARRL National Convention in New York July 21-22.

ARRL'S PETITION TO HAVE CABLE TV KEPT OFF THE AMATEUR BANDS has been rejected by the FCC. However, in their rejection the Commissioners put the cable TV industry firmly on notice that it has an obligation to prevent and remedy leakage problems, to all services.

**If you thought you were  
priced out of the satellite  
television market,  
Relax**

**We've got  
your  
System!**

World View Electronics has made owning a satellite television receiving system affordable with a choice of products manufactured by the most reputable names in the satellite TVRO industry.

Now you can choose the system that fits your needs and your pocketbook by ordering directly from World View Electronics.

For your convenience, we've packaged five systems together (Systems 1 through 5). Or if you wish, you can mix and match components to your own specifications.

Worried about installation? Relax. Installation is simple because each system we sell includes an installation guide that makes installing your system a breeze.

So call us today. With World View Electronics you don't have to give up quality for price.

**Nice Price & Good Advice  
1-502-781-6715**



World View  
Electronics

1527 US 31 West Bypass, Bowling Green, KY. 42101



# Ham Radio's BOOK STORE BUILDERS' SPECIAL

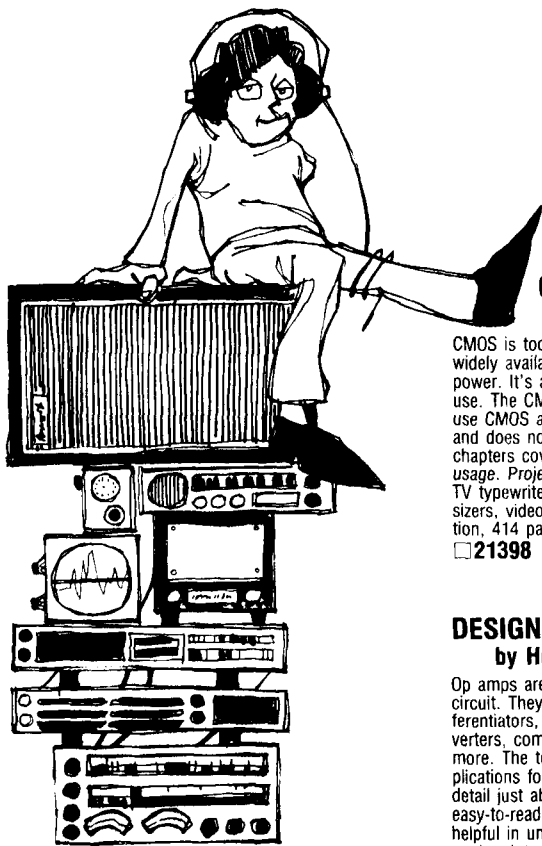

## CMOS COOKBOOK by Don Lancaster

CMOS is today's state-of-the-art! It's low cost, widely available and uses an absolute minimum of power. It's also fun to work with and very easy to use. The CMOS Cookbook is written to help you use CMOS and is chock-full of practical circuits and does not dwell on math or heavy theory. Eight chapters cover just about every aspect of CMOS usage. Projects include high-performance op-amps, TV typewriter, digital instruments, music synthesizers, video games and more. ©1977, 1st edition, 414 pages.

☐21398 Softbound \$13.95

## DESIGN OF OP AMP CIRCUITS by Howard Berlin, W3HB

Op amps are a versatile and inexpensive integrated circuit. They can be used for linear amplifiers, differentiators, integrators, voltage and current converters, comparators, rectifiers, oscillators and more. The text includes 37 different uses and applications for op-amps. Ten complete chapters detail just about every facet of the op-amp in an easy-to-read format. Beginners will find this book helpful in understanding exactly how an op-amp works. 1st edition, ©1977, 221 pages.

☐21537 Softbound \$11.95

## DESIGN OF ACTIVE FILTERS WITH EXPERIMENTS

by Howard Berlin, W3HB

Here's an excellent introduction to the theory, implementation and design of active filters using the 741 op-amp. This book starts the reader with an introduction to the 741 op-amp and then progresses to filter design basics. Also covered are first order low and high pass filters, second order voltage controlled voltage source filters, second order multiple feedback filters and more. Throughout the book, experiments are given to enable you to gain first hand experience on just how each filter operates. Great for all levels of electronic interest. 1st edition, ©1977, 239 pages.

☐21539 Softbound \$10.95

## DESIGN OF PHASE LOCKED LOOP CIRCUITS WITH EXPERIMENTS

by Howard Berlin, W3HB

Due to prohibitive costs, the phase loop circuit did not become widely used until the development of the monolithic IC and the incorporation of complete PLL circuitry inside these solid state devices. This book serves as an introduction to the theory, design and implementation of PLL using a variety of TTL and CMOS devices. Opening with an introduction of PLL, this book covers in a basic building block approach, the phase detector, voltage controlled oscillator and the loop filter. Appendices include manufacturers design information and description of breadboarding techniques. Experiments are included to ensure the reader fully understands PLL design nuances. 1st edition, ©1978, 255 pages.

☐21545 Softbound \$10.95

## IC OP AMP COOKBOOK by Walter Jung

This second edition is broadly updated in terms of device coverage. It includes the latest in state-of-the-art developments such as J Fet and MosFet in both single and multiple formats. This cookbook is edited into three basic parts. Part I introduces the IC op amp and discusses general considerations. Part II covers practical circuit applications. Part III is an appendix consisting of manufacturers and data sheets and other pertinent information. With the same clear, easy-to-read format of the first edition, you'll find the wealth of information, as well as over 200 practical circuit applications, to be invaluable. ©1980, 2nd edition, 480 pages.

☐21695 Softbound \$15.95

## SOLID STATE CIRCUIT FILES by Ed Noll, W3FQJ

These two volumes are full of interesting circuits. Volume 1 covers in three major sections; bipolar transistors, field effect transistors and linear integrated circuits. Volume 2 has two major sections; transistor logic digital circuits and CMOS circuit design. Over 60 basic and more advanced circuits allow for experimentation and study. Wherever possible, low cost devices are used to facilitate breadboarding. Ideal for schools or home study. Both editions ©1980, 1st edition.

Vol. 1 Bipolar Transistor FET and Linear IC  
☐21753 \$8.95

Vol. 2 TTL and CMOS Circuits  
☐21754 \$8.95

## MICROPROCESSOR CIRCUITS by Ed Noll, W3FQJ

Volume 1 presents basic concepts and fundamental circuits of microprocessor systems. Volume 2 presents microprocessor I/O circuits and programmable controllers. Each volume is written and edited in an uncomplicated manner. By using the experience gained from these books, the reader can progress to higher levels of computer complexity with a minimum of problems. Every attempt is made to keep costs down so that experimentation is facilitated. Both books, 1st edition, ©1983.

Vol. 1 Fundamentals & Microcontrollers  
☐21877 \$9.95

Vol. 2 I/O Interfacing and Programmable Controllers  
☐21977 \$9.95

## ELECTRONIC PROTOTYPE CONSTRUCTION

by Stephen D. Kasten

Here's a great book for either the beginner looking to try electronic prototyping for the first time or the expert looking for a handy reference guide. Areas covered include wire wrap and related techniques such as solder pad and perf. board assembly. When rough schematics are converted to PC boards, this book will help you through all the pitfalls of PC board design. It will also give you handy tips on how to make PC boards simply, with a minimum of fuss. Finally, when the project is nearing completion, you must consider packaging or how to put it all together in an attractive but functional package. Great reference book! 1st edition, ©1983, 399 pages.

☐21895 Softbound \$17.95

## MODERN DICTIONARY OF ELECTRONICS — 6th Edition by Rudolf Graf

This book should be in every ham's library. It has over 20,000 terms unique to electronics and other closely related fields. 3000 additions to the 5th edition and twice the size of the 1st edition! From A or angstrom to zoom lens, you'll find it in this updated dictionary. 6th edition, ©1984, 1152 pages.

☐22041 Hardbound \$39.95

## TTL COOKBOOK by Don Lancaster

Despite the advent of CMOS, there is still plenty of design work being done with TTL circuitry. This book gives you a broad overview of exactly what TTL is, how it works and is full of design ideas and practical circuits. Some areas that receive attention are, flip-flops, clocked logic, counters and counting techniques, noise generators and much more. You also get a complete discussion of practical TTL applications including digital counter, events counter, stopwatch and voltmeter to name just a few. ©1974, 1st edition, 333 pages.

☐21035 Softbound \$12.95

## ACTIVE FILTER COOKBOOK by Don Lancaster

Active filters are unique combinations of integrated circuits, resistors and capacitors. They give excellent performance from sub-audible to ultrasonic frequencies. And they are relatively low in cost, simple to design and construct. This book is written for the user and will help you tailor filters to specific needs or applications. Ten chapters are full of helpful information and are illustrated with plenty of drawings and circuits. ©1975, 1st edition, 240 pages.

☐21168 Softbound \$14.95

PLEASE ADD \$2.50 FOR SHIPPING AND HANDLING  
FOREIGN ORDERS FOB GREENVILLE

✓ 140



**ham  
radio** magazine **BOOKSTORE**

# THE STARS ARE YOURS

**STARFINDER** now makes it possible to position your antenna from the comfort of your favorite chair . . . The **imp**, an optional infra-red remote with hand-held control has been designed to interface with the programmable (up to 80 positions), micro-processor-based **STARFINDER**, with extraordinary user-friendliness. **SST** is a self-contained, east/west switch with built-in infra-red remote designed for affordable antenna positioning, and easy installation. The stars are yours now with **STARFINDER** . . . for dealer information and the **STARFINDER** dealer closest to you, please contact . . .



## STARFINDER, INC.

2960 South West Temple  
Salt Lake City, Utah 84115  
1-800-742-5924 then 15864 (touchtone)  
(801) 467-2793



Distributors:

ATHENIAN PRODUCTS Athens, Alabama (205)232-0143 BANKS SATELLITE SYSTEMS Greenwood, SC (803) 229-4630  
DEWAALS VIDEO San Antonio, TX (512)680-7111 MID-STATE TV EARTH STATIONS Pineville, LA (318) 640-9890  
PACIFIC COAST SATELLITE TV INC Fresno, CA (209) 275-2322 (800) 468-0593 S.F. DISTRIBUTING Salt Lake City, UT (801)261-3474  
SYSTEMS DISTRIBUTING Sebastopol, CA (707)823-6236



Cards and plaque courtesy W6TC

# EIMAC's new DX champion! The 3CX800A7.

Varian EIMAC continues to commit its development of reliable tubes for HAM radio.

The new, rugged 3CX800A7 power triode provides 2 kW PEP input for voice service or 1 kW cw rating up to 30 MHz. Two tubes will meet the new, higher power ratings authorized by the FCC.

Designed for today's low profile, compact linear amplifiers, the 3CX800A7 powerhouse is only

2½ inches (6.35 cm) high. Cooling requirements are modest and a matching socket, air chimney and anode clamp are available.

A data sheet and more information is available from Varian EIMAC. Or the nearest Electron Device Group sales office. Call or write today.

Varian EIMAC  
301 Industrial Way  
San Carlos, California 94270  
Telephone: 415-592-1221





# JPC/AZDEN<sup>®</sup>

## 4000 SERIES

### FM TRANSCEIVERS

#### 10 METERS & DOWN



COMMERCIAL-GRADE  
QUALITY AT AMATEUR PRICES

**EXCLUSIVE 1 YEAR LIMITED WARRANTY! COMPARE!**



PCS-4000  
2-m FM Transceiver

#### THE 4000 SERIES



PCS-4300 70-cm FM Transceiver



PCS-4500 6-m FM Transceiver



PCS-4800 10-m FM Transceiver

**SALE**

**PLEASE CALL FOR  
SPECIAL PRICE**

PCS-300  
2m Handheld  
FM Transceiver  
142-149.995 MHz

✓ 111

- **WIDE FREQUENCY COVERAGE:** PCS-4000 covers 142,000-149,995 MHz in selectable steps of 5 or 10 kHz. PCS-4200 covers 220,000-224,995 MHz in selectable steps of 5 or 20 kHz. PCS-4300 covers 440,000-449,995 MHz in selectable steps of 5 or 25 kHz. PCS-4500 covers 50,000-53,995 MHz in selectable steps of 5 or 10 kHz. PCS-4800 covers 28,000-29,990 MHz in selectable steps of 10 or 20 kHz.
- **CAP/MARS BUILT IN:** PCS-4000 includes coverage of CAP and MARS frequencies.
- **TINY SIZE:** Only 2" H x 5.5" W x 6.8" D. COMPARE!
- **MICROCOMPUTER CONTROL:** At the forefront of technology!
- **UP TO 8 NONSTANDARD SPLITS:** Ultimate versatility. COMPARE!
- **16-CHANNEL MEMORY IN TWO 8-CHANNEL BANKS:** Retains frequency and standard simplex or plus/minus offsets. Standard offsets are 600 kHz for PCS-4000, 1.6 MHz for PCS-4200, 5 MHz for PCS-4300, 1 MHz for PCS-4500, and 100 kHz for PCS-4800.
- **DUAL MEMORY SCAN:** Scan memory banks either separately or together. COMPARE!
- **TWO RANGES OF PROGRAMMABLE BAND SCANNING:** Limits are quickly reset. Scan the two segments either separately or together. COMPARE!
- **FREE AND VACANT SCAN MODES:** Free scanning stops 5 seconds on a busy channel; auto-resume can be overridden if desired. Vacant scanning stops on unoccupied frequencies.
- **DISCRIMINATOR SCAN CENTERING (AZDEN EXCLUSIVE PATENT):** Always stops on frequency.
- **TWO PRIORITY MEMORIES:** Either may be instantly recalled at any time. COMPARE!
- **NICAD MEMORY BACKUP:** Never lose the programmed channels!
- **FREQUENCY REVERSE:** The touch of a single button inverts the transmit and receive frequencies,

no matter what the offset.

- **ILLUMINATED KEYBOARD WITH ACQUISITION TONE:** Unparalleled ease of operation.
- **BRIGHT GREEN LED FREQUENCY DISPLAY:** Easily visible, even in direct sunlight.
- **DIGITAL S/R F METER:** Shows incoming signal strength and relative power output.
- **BUSY-CHANNEL AND TRANSMIT INDICATORS:** Bright LEDs show when a channel is busy and when you are transmitting.
- **FULL 16-KEY TOUCHTONE<sup>®</sup> PAD:** Keyboard functions as autopatch when transmitting (except in PCS-4800).
- **PL TONE:** Optional PL tone unit allows access to private-line repeaters. Deviation and tone frequency are fully adjustable.
- **TRUE FM:** Not phase modulation. Unsurpassed intelligibility and audio fidelity.
- **HIGH/LOW POWER OUTPUT:** 25 or 5 watts selectable in PCS-4000; 10 or 1 watt selectable in PCS-4200, PCS-4300, PCS-4500, and PCS-4800. Transmitter power is fully adjustable.
- **SUPERIOR RECEIVER:** Sensitivity is 0.2 uV or better for 20-dB quieting. Circuits are designed and manufactured to rigorous specifications for exceptional performance, second to none. COMPARE!
- **REMOTE-CONTROL MICROPHONE:** Memory A-1 call, up/down manual scan, and memory address functions may be performed without touching the front panel! COMPARE!
- **OTHER FEATURES:** Dynamic microphone, rugged built-in speaker, mobile mounting bracket, remote speaker jack, and all cords, plugs, fuses, and hardware are included.
- **ACCESSORIES:** CS-7R 7-amp ac power supply, CS-4.5R 4.5-amp ac power supply, CS-AS remote speaker, and Communications Specialists SS-32 PL tone module.
- **ONE YEAR LIMITED WARRANTY!**

EXCLUSIVE DISTRIBUTOR:

DEALER INQUIRIES INVITED

**AMATEUR-WHOLESALE ELECTRONICS**

**TOLL FREE... 800-327-3102**

8817 S.W. 129th Terrace, Miami, Florida 33176

Telephone (305) 233-3631

Telex: 80-3356

MANUFACTURER:

**JPC/AZDEN**

**JAPAN PIEZO CO., LTD.**

1-12-17 Kamirenjaku, Mitaka, Tokyo, 181 Japan.

Telex: 781-2822452



# The First Name In Satellite TV...

When you invest in a **DRAKE** Earth Station Receiver, you've chosen the very finest. Elegantly designed with the latest engineering concepts in solid-state techniques, every **DRAKE** is characterized by superb performance and versatility. **DRAKE**... world-class leader in satellite television reception.



## ESR240 EARTH STATION RECEIVER

- Infrared Remote Control
- Digital Channel Readout
- Preset 6.2/6.8 and Variable Audio Tuning



## ESR324 EARTH STATION RECEIVER

- Digital Channel Readout
- Detent Channel Tuning
- Preset 6.8 and Variable Audio Tuning

# ...The Last Word In Performance!



R.L. Drake Company  
540 Richard Street, Miamisburg, Ohio 45342, USA  
Phone: (513) 866-2421  
Telex: 288-017

PIONEER MEMBER OF  
**SPACE**

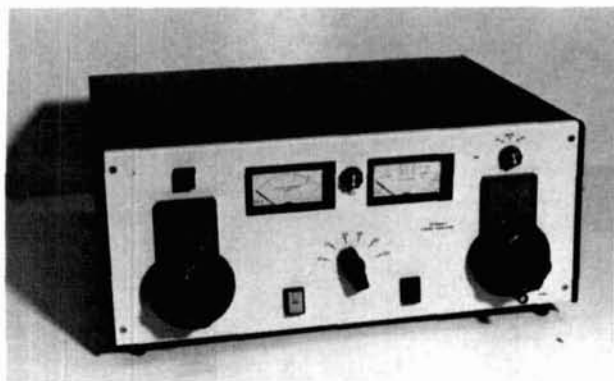

## a 3CX800A7 linear amplifier

1500 watts out  
on 10-160 meters,  
using a pair of  
EIMAC's new  
compact tubes

It took me about thirty seconds to accept *ham radio's* invitation to design and build a new high-frequency linear amplifier centered around EIMAC's new 3CX800A7 triode. I decided immediately that the design should capitalize on the small size of the tubes, cover the 10 through 160 meter bands, and be capable of meeting the new 1500 watt output power limit on a continuous basis. In other words, I wanted a small desk-top amplifier that "growled." My approach to the project was similar to the modular technique described in my previous *ham radio* article<sup>1</sup> and to the structured approach to equipment design outlined earlier in *QST*.<sup>2</sup>

In this article, I have made a special effort to provide the detail necessary to allow readers to easily duplicate my efforts. I have provided detailed layouts of the circuit boards and tried to identify sources for the parts where available. Readers who duplicate the design exactly should experience few problems.

Some unusual parts — a 500 pF/3000 volt vacuum variable capacitor and an RF vacuum relay — for example — are used. In each case, effort has been made to identify these parts and suggest alternative components that are more readily available.

I have also included construction details for a matching high voltage power supply. Remember that a well-regulated power supply is one key to making an amplifier perform well.

### RF deck circuit design

The amplifier is designed around a pair of EIMAC 3CX800A7 high- $\mu$  power triodes that are capable of 15 dB gain. The tubes are very compact, measuring only 2-1/2 inches (6.35 cm) high and 2-1/2 inches in diameter. A matching socket, chimney, and plate connector are also available.

The amplifier uses a tuned input network (**fig. 1**) ganged to the main band switch to minimize distortion products and provide a good match to the exciter. Maximum SWR presented to the exciter is 1.3:1. Because of the high gain of the tubes (i.e. 15 dB) only about 60 watts is needed to drive the amplifier to the new 1500 watt output power limit. Therefore, a very effective ALC circuit (see **fig. 2**) also has been included to control drive power. (See ALC module PC board and component layout.)

Output matching is accomplished using a Pi-L circuit designed for a  $Q$  of 12. Toroids in both the input and output circuit have been used for compactness.

Also included is a very effective grid trip circuit that latches the amplifier out of operation should the grid current exceed 90 milliamperes (45 milliamperes per tube). This feature provides positive protection for the tubes against excessive grid current. This is especially important with these tubes since the grids are capable of dissipating only 4.0 watts. If the protective circuit does trip, it can be reset by pushing a front panel mounted switch. However, the reason it tripped

By Jerry L. Pittenger, K8RA, 2165 Sumac Loop  
South, Columbus, Ohio 43229

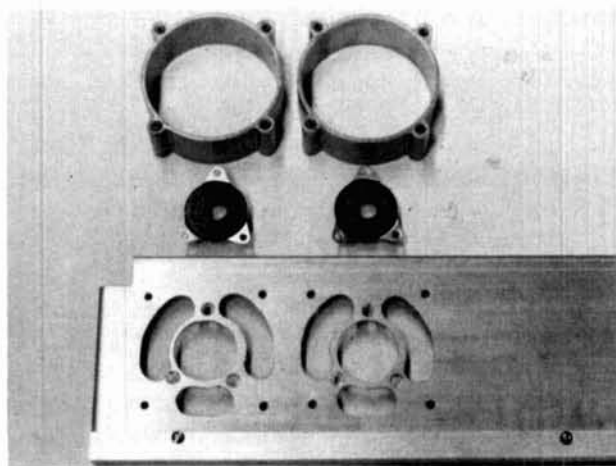
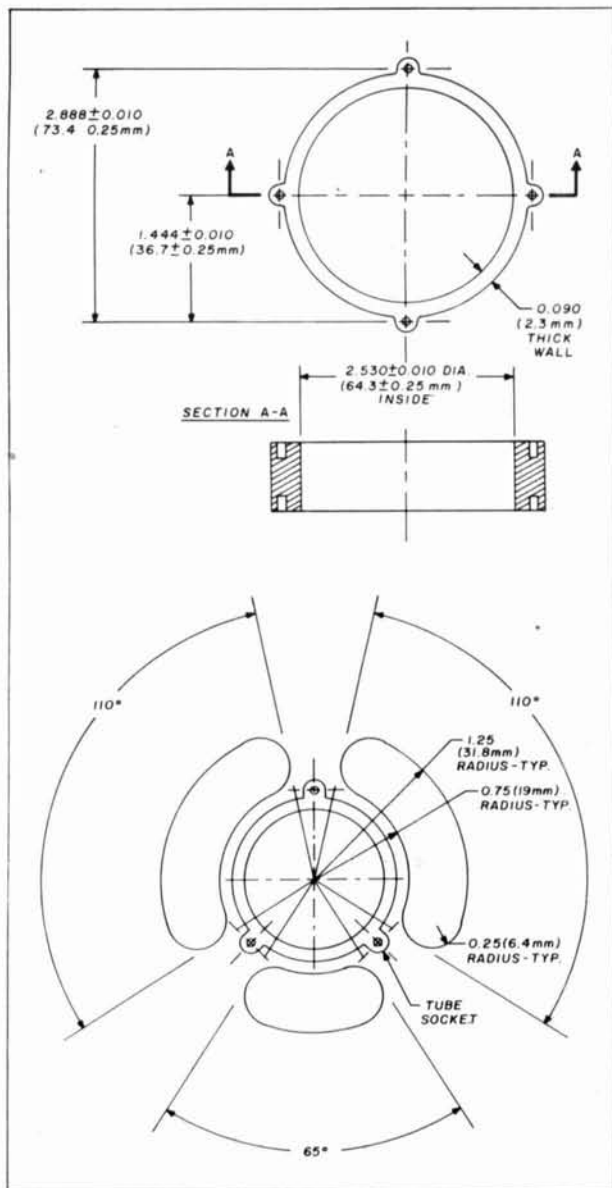

Mounting details for 3CX800A7. Sockets and chimneys available from EIMAC.

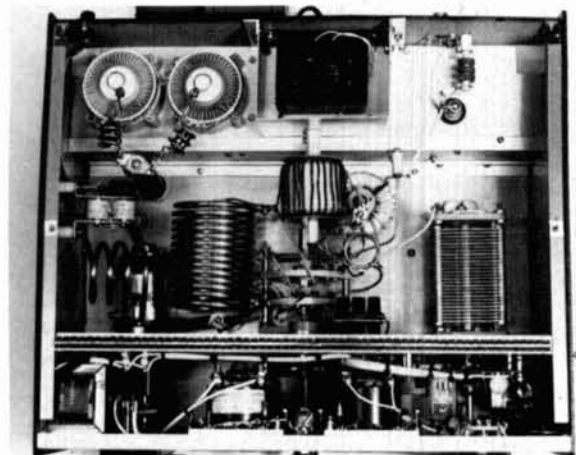

Top view of amplifier: Note shield for filament transformer; finger stock isolates meter compartment from main RF compartment.

in the first place should be determined before resetting the switch.

Additional protective devices include a solid-state time delay circuit that prevents operation of the amplifier for approximately 3 minutes until the indirectly heated cathodes of the tubes are properly conditioned. The HV can not be turned on during this period. After warm-up, a relay actuates that allows the amplifier to be keyed up by the exciter and also sends AC power to the HV power supply to allow HV to be applied to the plates of the tubes.

A regulated 26 VDC power supply has been included to provide power for meter and switch pilot lights and relay control. The supply is regulated to avoid pilot light dimming under varying current loads.

### amplifier control circuitry

The control circuitry for this amplifier is quite simple. 110 VAC enters the RF deck control circuit (fig. 3) from the HV power supply. When the front panel FIL power switch is actuated, AC power is applied to the blower, filament transformer and 26 VDC regulated power supply module. (See PC board and component layout.) The 26 VDC supply, in turn, applies power to the timing module, which starts the three minute warm-up cycle. When the warm-up cycle is over, the meter lights come on indicating that the amplifier is ready to operate. Note, actuating the front panel "HV" power switch will not send power to the HV power supply until the 3-minute warm-up cycle has completed.

The 26 VDC power supply uses an LM317 voltage regulator which can malfunction in the presence of strong RF fields. Consequently good design practices require careful placement. In this design, the 26 VDC supply is located up in the front meter compartment far away from RF.



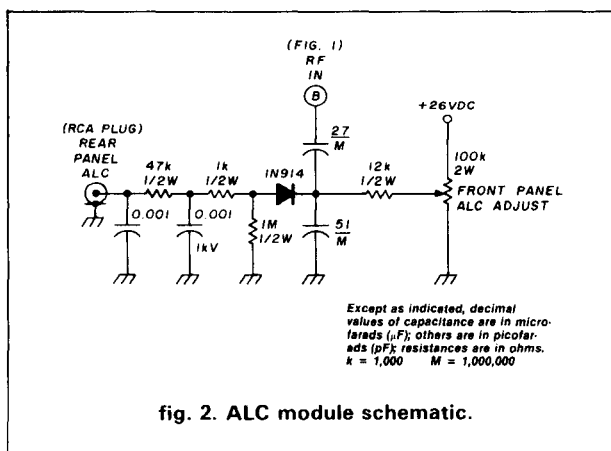
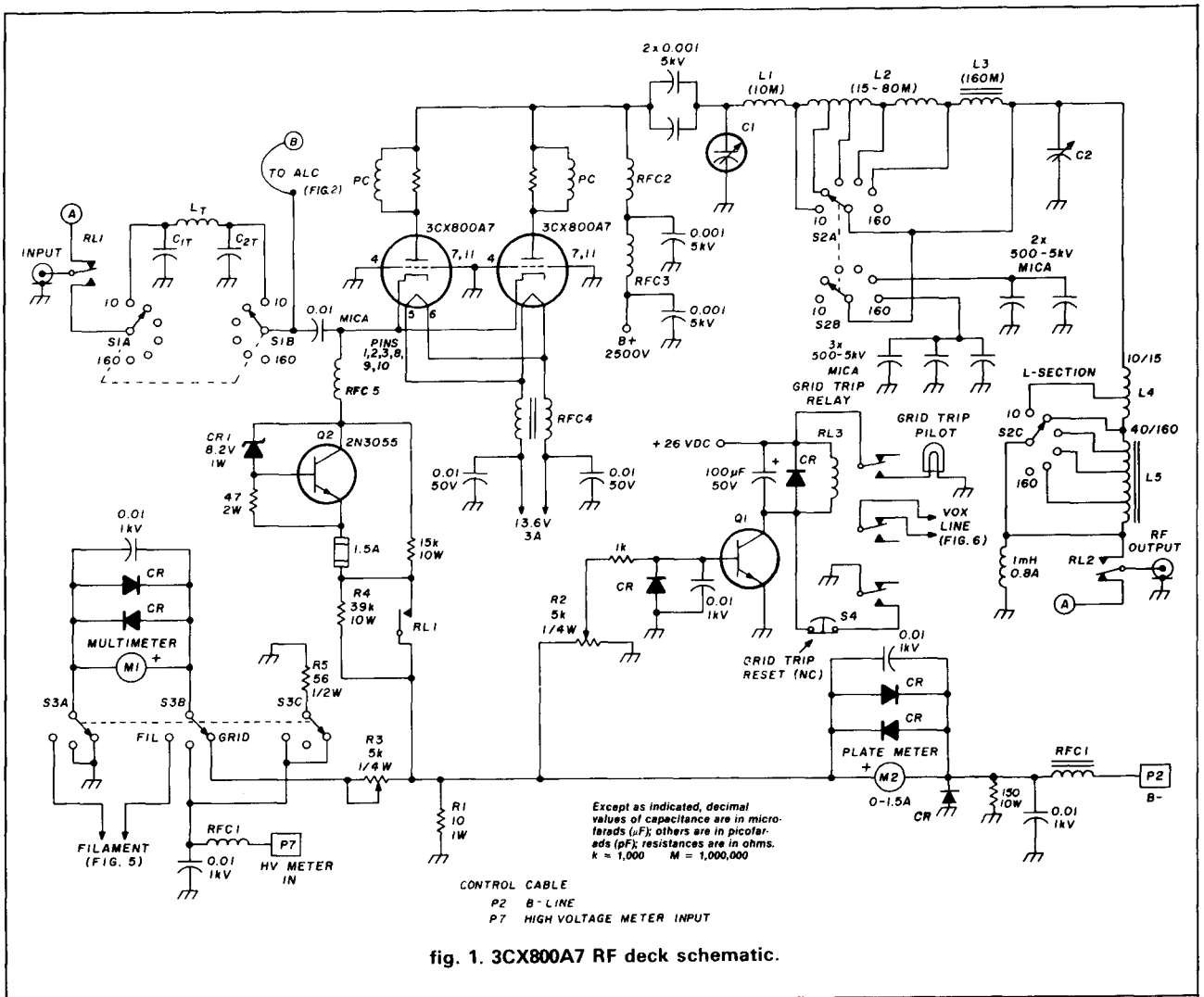

### grid-trip protection circuit

A grid trip module has been included to disable the amplifier should the grid current rise to levels dangerous to the tubes. A pair of 3CX800A7s is rated for a maximum grid current of 120 milliamperes (mils).

Under normal operation, a pair of tubes draws about 30 mils. Therefore, I have the circuit adjusted to trip at 90 mils of grid current. When the circuit trips, relay RL3 (see fig. 1) is actuated which breaks the VOX line, thus deactivating the amplifier and lighting the "grid trip reset" push button on the front panel of the amplifier. It is necessary to push the RESET button to put the amplifier back into operation. Of course, one should determine why the amplifier exceeded 90 mils before resetting.

The circuit is actually quite simple. As grid current flows through R1, a voltage is developed across the resistor. The grid trip actuates when transistor Q1 is turned on (approximately 0.6 volts appears on the base). For example, if the base of Q1 were tied directly to R1, 60 milliamperes would generate 0.6 volt ( $E = IR = 0.060 \times 10 = 0.6$  volts). But this current is too low in normal operation to trip the grid current protection circuit. Therefore, a voltage divider is needed if a current different than 60 milliamperes is desired to actuate the grid trip. This voltage divider



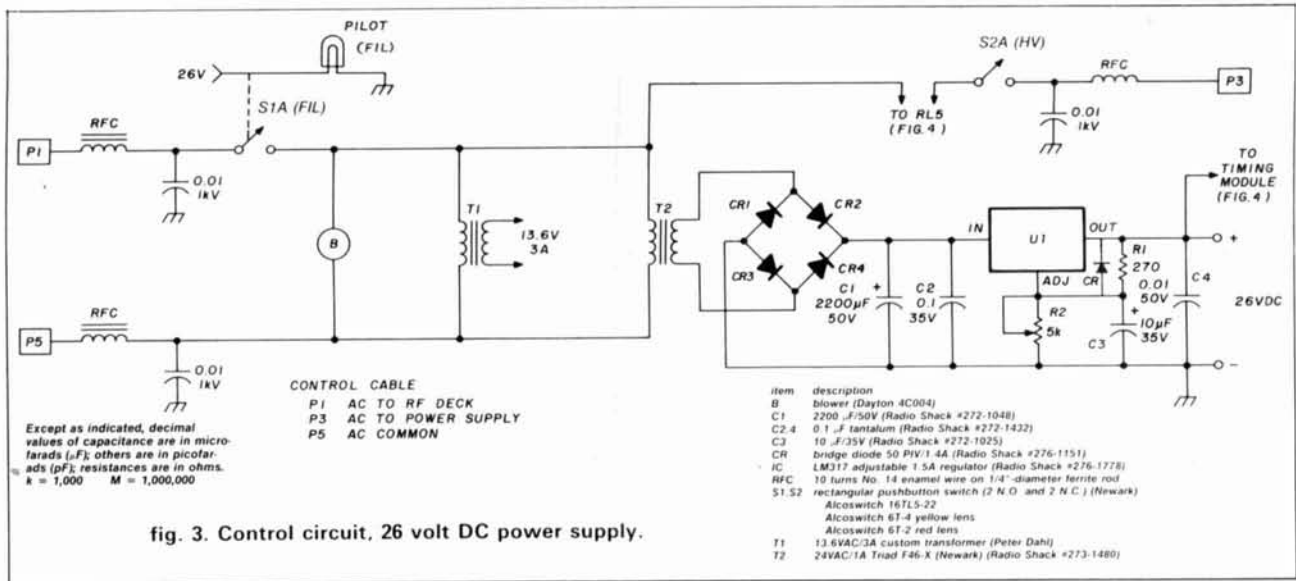

fig. 3. Control circuit, 26 volt DC power supply.

parts list for fig. 1

item	description
C1	500 pF/3kV vacuum variable (air variable can be substituted)
C2	850 pF/1kV air variable
CR	1000 PIV/2.5A (RS 276-1114)
CR1	8.2V zener diode, Motorola 1N4738 (Newark)
C1,C2	(see table 1)
L1	(see table 1)
L1,L5	(see table 2)
M1,M2	Triplet model 220G, 1 mA movements (152-0152), Bezels No. 13-238 M2 shunted to read 1.5A full scale
PC	4 turns No. 10 buss wire wound around 3 150 ohm 2-watt carbon resistors in parallel
Q1	2N3053 (RS 276-2030)
Q2	2N3055 (RS 276-2041)
RFC1	10 turns, No. 14 enameled wire on 1/4-inch diameter ferrite rod
RFC2	plate choke from Drake L7 amplifier
RFC3	11 turns No. 14 enameled wire, 5/8-inch diameter
RFC4	22 turns bifilar, 4-inches long on a 1/2-inch diameter ferrite rod
RFC5	70 turns No. 18 on 1/2" diameter nylon rod
RL1	(see fig. 6)
RL2	(see fig. 6)
RL3	4PDT Potter and Brumfield KHU17D11/24 VDC coil (Newark)
S1	2 pole/6 position, Centralab PA2003 (Newark 22F603)
S2	model 86 non-shorting switch, 3 pole, 6 position at 30 degree indexing (Radio Switch)
S3	3 pole/3 position 1 section, Centralab PS109 (Newark 22F777) or Centralab 2507 (Newark 22F414)
S4	momentary pushbutton 1 N.O., 1 N.C. ALCO 16SL-11 switch ALCO 6S-2 red lens
tube sockets:	EIMAC SK1900
tube chimneys:	EIMAC SK1906
tube clamp:	EIMAC SK1916
cabinet 7 x 17 x 14 inches,	CTS model MCLS-71714, SPP-714 side panels.
CP-1714 chassis plate	

\*parts suppliers:

name and address	name and address
CTS Interfab 660 Lenfest Road San Jose, California 65133 Tel: 408-251-1600	Newark Electronics 500 N. Pulaski Road Chicago, Illinois 60624 Tel: 312-638-4411
Peter Dahl Transformer Co. 4007 Fort Blvd. El Paso, Texas 79930 Tel: 915-566-5365	Radio Shack Local stores
W.W. Granger (Dayton) P.O. Box 44289 Columbus, Ohio 43204 Tel: 614-276-5231	Triplett Corporation 286 Harmon Road Bluffton, Ohio 45817 Tel: 419-358-5015
R.L. Drake Co. 540 Richard Street Miamisburg, Ohio 45342 Tel: 513-866-2421	Radio Switch Corp. Marlboro, New Jersey 07746 Tel: 201-462-6100

RS = Radio Shack™

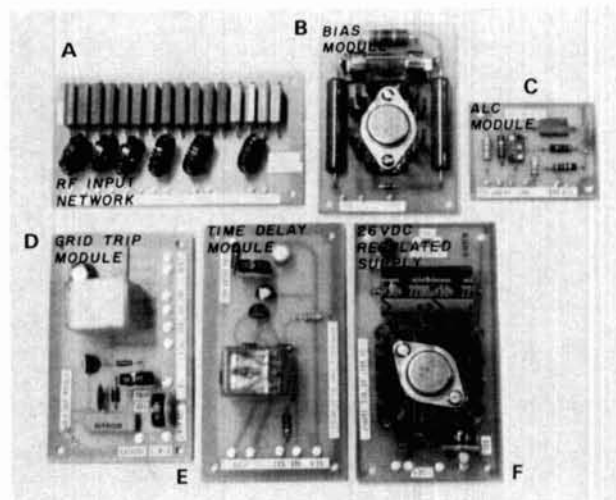

All circuit boards are made from glass epoxy boards and laid out using dry transfers from Radio Shack. (Letter codes refer to ready-to-use PC board artwork printed on page 139.)

disabling the amplifier. Another set of contacts applies power to the grid trip reset pilot light on the front panel indicating to the operator what has happened. Pushing the reset button on the front panel breaks the coil line, which in turn unlatches relay RL3 and puts the amplifier back into normal operation. (See grid trip module PC board and component layout.)

I have used this circuit in several different amplifiers. It is a good addition to any amplifier that you might build considering the high price of tubes.

### solid-state timing module

The 3-minute timing circuit used to insure proper conditioning of the 3CX800A7s cathodes is shown in fig. 4. When the 26 VDC power supply comes on, current begins to flow through the 5.5M resistor R1,

is created with the trim pot R2, which can be used to adjust the level at which the circuit trips (Q1 is turned on).

If Q1 turns on, relay RL3 actuates, grounding the relay coil and taking the load off transistor Q1. If this feature were not provided, the transistor would start gating the amplifier on and off. Therefore, it is essential to latch the grid trip relay closed. When RL3 is closed another set of contacts breaks the VOX line,

# Gillaspie 9600

*Micro Processor Controlled Satellite Receiver*

*with wireless remote*



- Clear sharp pictures
- Automatic Feed Rotation Control
- Built-in Satellite TV Switch
- Super Reliability
- Channel 3 - 4 Switchable Modulator
- Fine Wood Cabinet with Distinctive Styling

DEALER AND DISTRIBUTOR INQUIRIES WELCOME!

# Gillaspie L.N.A.

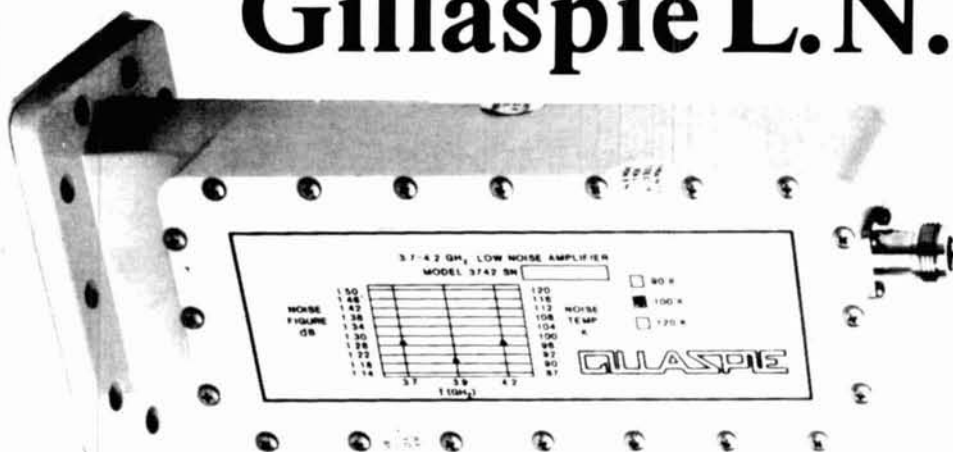

*Low Noise Amplifier*

*Model #  
GLN-3742*

- Full Band Coverage (3.7 GHz - 4.2 GHz)
- 100°K Max. Noise Temperature (GLN - 3742 - 100)
- 120°K Max. Noise Temperature (GLN - 3742 - 120)
- 50 db Gain (typical)
- DC Bias at 15v to 28v (150 mA max)
- CPR 229 Waveguide Input
- Input VSWR 1.3 - Output VSWR 1.5
- Single "N" Female Connector for RF Output & DC Bias
- Compact Design 3.1" x 3.9" x 8.4"
- Hermetically sealed
- Replaces any TVRO LNA
- 1 Year Warranty

DEALER AND DISTRIBUTOR INQUIRIES WELCOMED

**NEVADA SATELLITE 702 • 452-5509**

P.O. Box 2 - Las Vegas, Nevada 89125

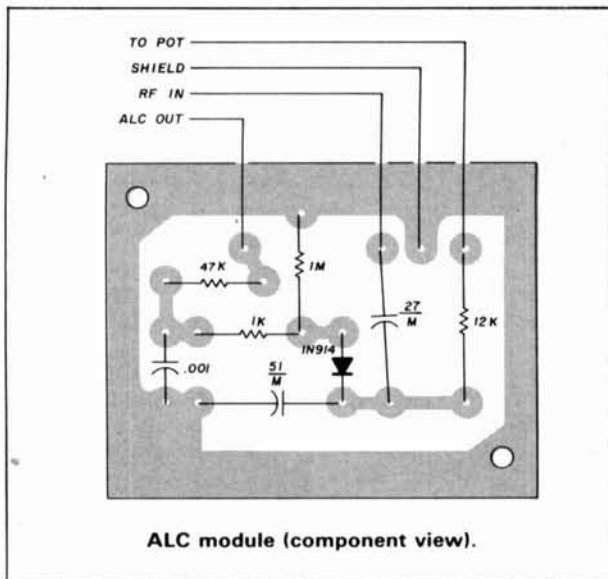

charging the 22  $\mu$ F capacitor, C1. As C1 charges, the voltage is applied to the base of a Darlington configuration (Q1 and Q2) which forms an emitter follower circuit. Therefore, the emitter of the Darlington follows the voltage charge on capacitor C1. The Darlington is necessary to present a high impedance to C1 which would otherwise drain through the transistor. Relay RL5 is a 12 VDC relay that actuates at approximately 8.1 volts. Therefore when the voltage on C1 causes the emitter of Q2 to reach 8.1 volts, relay RL5 actuates allowing amplifier operation. Of course, this takes approximately 3 minutes.

Relay RL5 is a 4PDT relay. Two poles are wired in parallel and apply power to the HV power switch located on the front panel. Therefore, the HV power supply cannot be turned on during the warm-up period. Another set of contacts on RL5 is used to connect a 3-megohm resistor to C1 to discharge the capacitor thus resetting the timer module. This is a protective circuit to insure that a 3-minute warm-up cycle occurs should the amplifier be turned off for a short time and then turned back on. The fourth set of contacts serves three purposes. First, the meter lights come on, indicating an amplifier-ready condition. Second, 26 VDC is sent to the hot side of relay RL5 in the timing module itself thus latching the relay. This takes the power load off the Darlington and allows the reset function discussed above. Diode CR2 prevents the voltage on the VOX line to rise with the emitter on Q2. Third, 26 VDC is sent to the VOX line to allow the amplifier to be keyed up.

Note that it is extremely important to get a high impedance Darlington with very low leakage current to make this circuit work properly. I originally tried three different single package Darlington's with no success. The transistors used are readily available

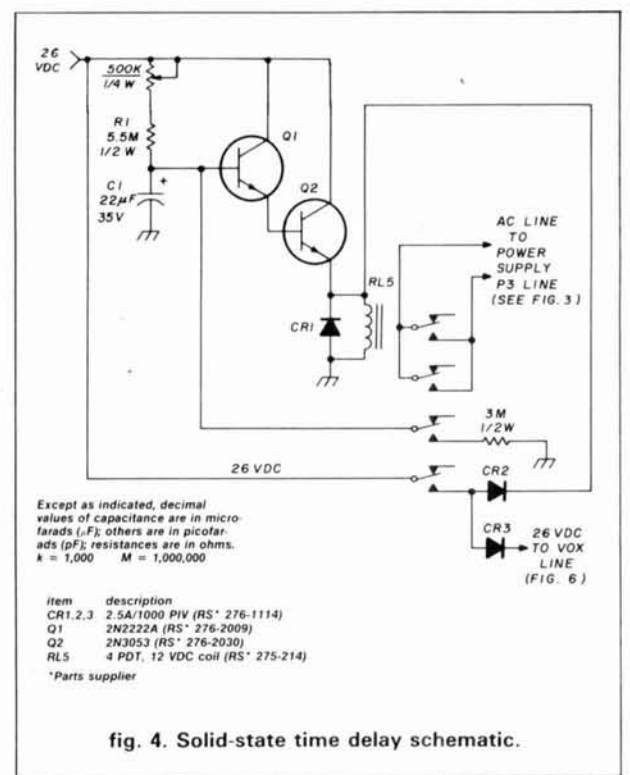
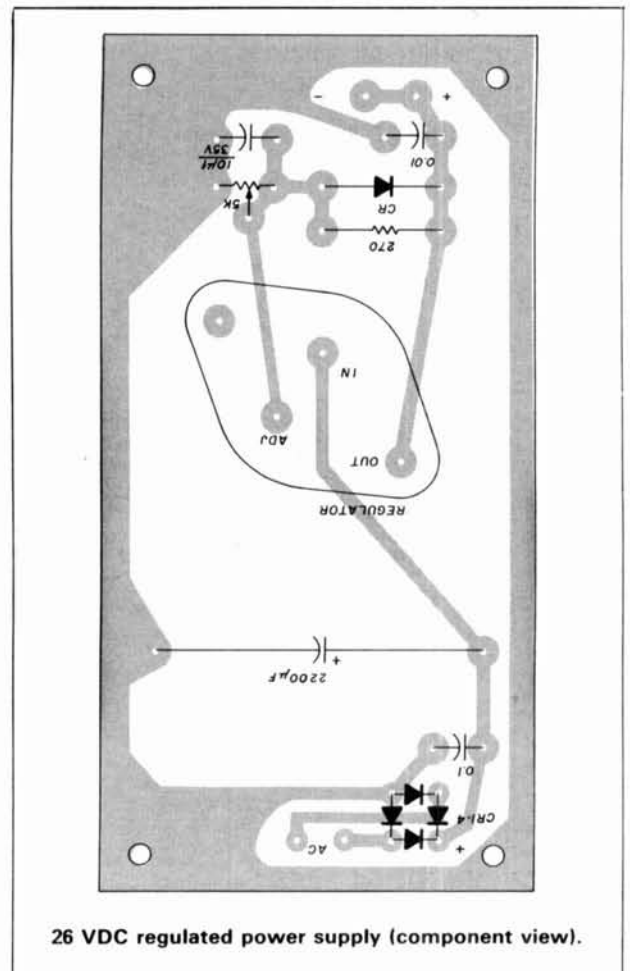

- Except as indicated, decimal values of capacitance are in microfarads ( $\mu$ F); others are in picofarads (pF); resistances are in ohms. k = 1,000 M = 1,000,000
- | item    | description                      |
|---------|----------------------------------|
| CR1,2,3 | 2.5A/1000 PIV (RS* 276-1114)     |
| Q1      | 2N2222A (RS* 276-2009)           |
| Q2      | 2N3053 (RS* 276-2030)            |
| RL5     | 4 PDT, 12 VDC coil (RS* 275-214) |
- \*Parts supplier

from Radio Shack and I recommend you use these exact components. (See timer module PC board and component layout.)

### operating bias circuit

Operating bias is generated through use of a high-power 2N3055 NPN transistor (Q2) which is biased by a 1-watt zener diode to function as a high power zener (see **fig. 1**). This circuit includes readily available components and provides an easy way to adjust the bias voltage merely by changing the 1-watt zener diode between the base and collector of the 2N3055. This amplifier is biased with 8.2 volts which results in a 40 milli-ampere zero signal resting plate current.

This circuit is much easier to work with than the

more conventional 50-watt zener diodes. Here in the Midwest the 50 watt TO3 case zeners are very expensive special order items.

The bias circuit also has a 1.5 amp fuse to protect against excessive current. The current flowing through this circuit is the sum of the plate and grid current drawn by the tubes.

In the standby mode, the amplifier is biased to cut off (i.e. zero static plate current) by voltage generated by the current flow through the 39K resistor, R4. The resistor is shorted in the transmit mode by a set of contacts on the RF input relay RL1.

The bias circuit in the amplifier has been constructed as a single module. The module is located on the side wall of the cabinet next to the tube sockets and RF choke RFC5. (See bias module PC board and component layout.)

### metering circuits

Metering is provided for plate current, grid current, high voltage, and filament voltage.

Plate current is monitored at all times. This meter is in series with the B-lead.

The other metered values are selected on the multimeter. The meter can be anything from a 100 micro-ampere meter to a 5 milliampere meter full scale. You can make any of the meters work by choosing the proper calibration resistor. I used a 1 mA movement.

Grid current is measured by monitoring the voltage across the 10-ohm resistor (R1) through which grid current is drawn (refer to the discussion on the grid-trip module). Trim pot R3 is used to calibrate the meter to read full scale when 100 milliamperes is drawn through R1.

High voltage is measured by monitoring a low voltage value developed by a voltage divider in the power supply. This voltage should be kept very low since it is sent through the control cable that connects the amplifier to the power supply.

Filament voltage is very simple to monitor (see **fig. 5**) and often an ignored value in amplifier designs. A filament voltage that is too high can lead to premature tube failure. The meter has been calibrated from 10 to 15 volts. A 9.1 volt zener diode and a silicon diode are used to convert the AC filament voltage to DC and allow the bottom scale on the meter to be approximately 10 volts. No current flows in the metering circuit until the voltage across the zener diode exceeds 10 volts. (See filament voltage metering PC board and component layout.)

Labeling the meters takes a lot of patience but really contributes to the appearance of the amplifier. It is necessary to choose a meter with an analog scale that has the correct number of divisions. However, the meter labeling makes no difference. In a very clean environment, remove the meter plate from the meter.

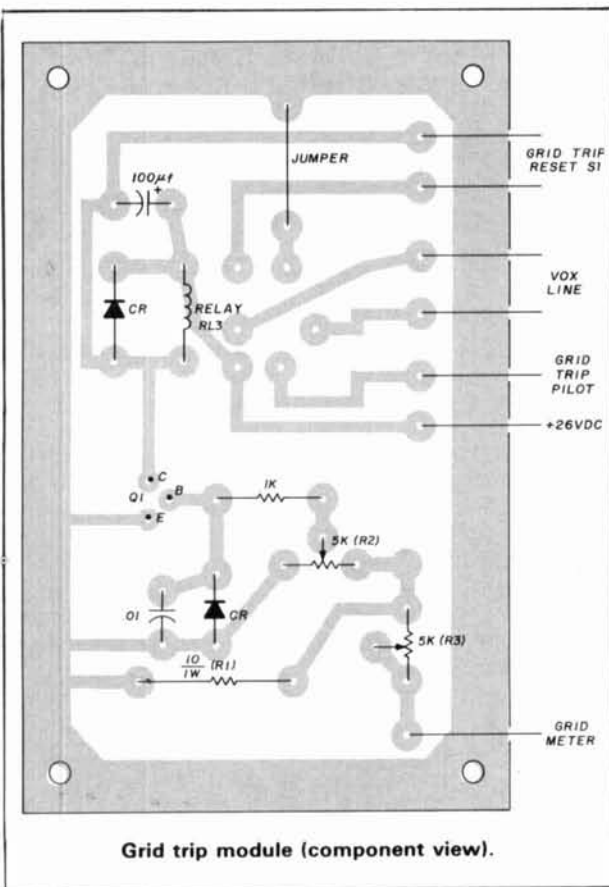

Grid trip module (component view).

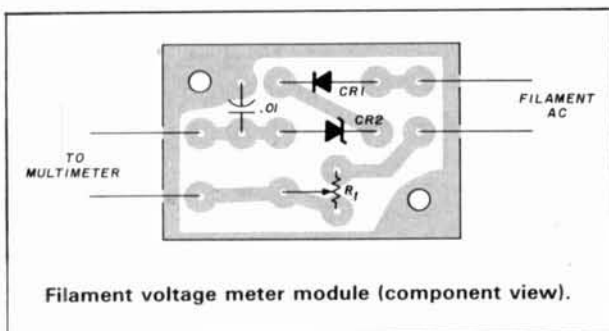

Filament voltage meter module (component view).



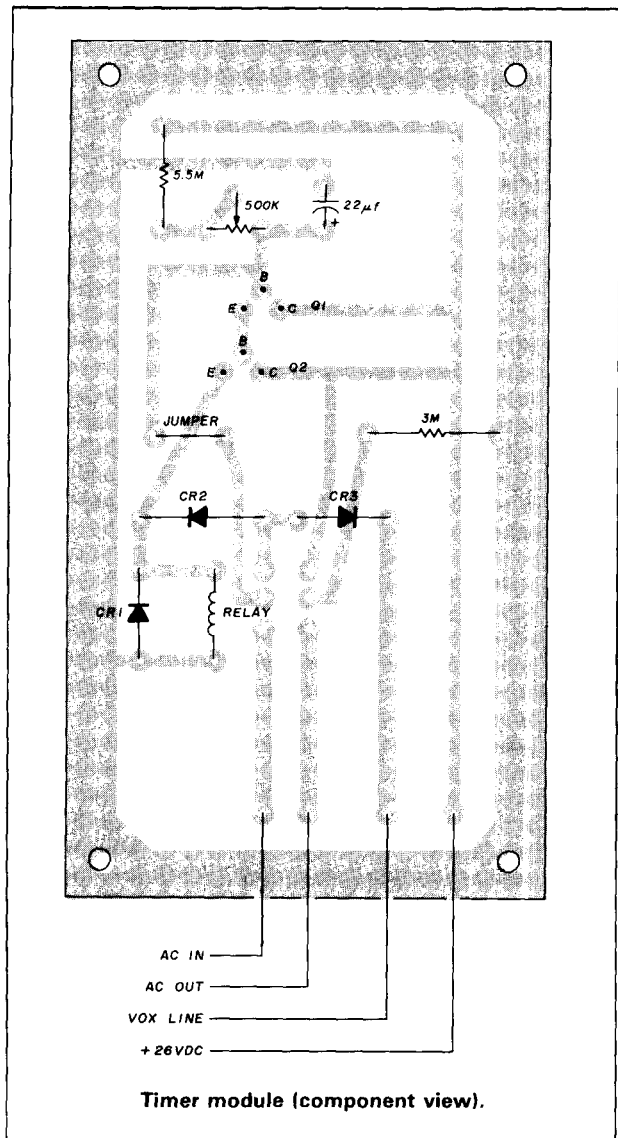

are now available from Radio Shack but the letters may be too large for small meters. Varied assortments of smaller letters are available from most art supply stores.

### RF relay sequencing

It is important to properly sequence the input RF relay (RL1) and the high power output vacuum relay (RL2) to insure that the antenna is always connected to the amplifier before RF drive power is applied. This

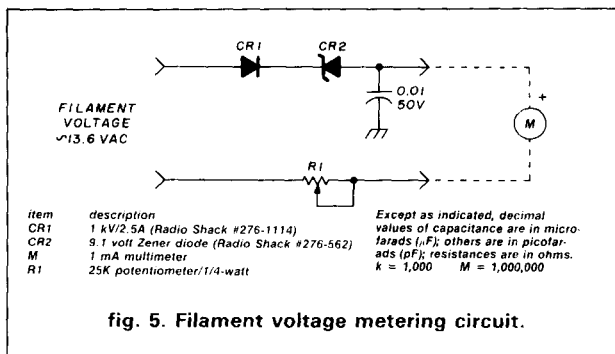
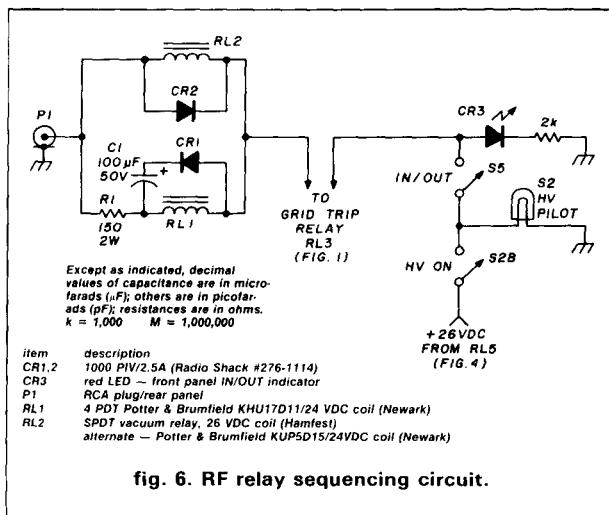

Any markings on the meter can be removed with a pencil eraser. Rub lightly, but be persistent. The markings will come off the face leaving a clean surface to which the number and letter markings can be applied. I use dry transfer lettering to mark the meter plates to reflect the scales I want to read. Dry transfers

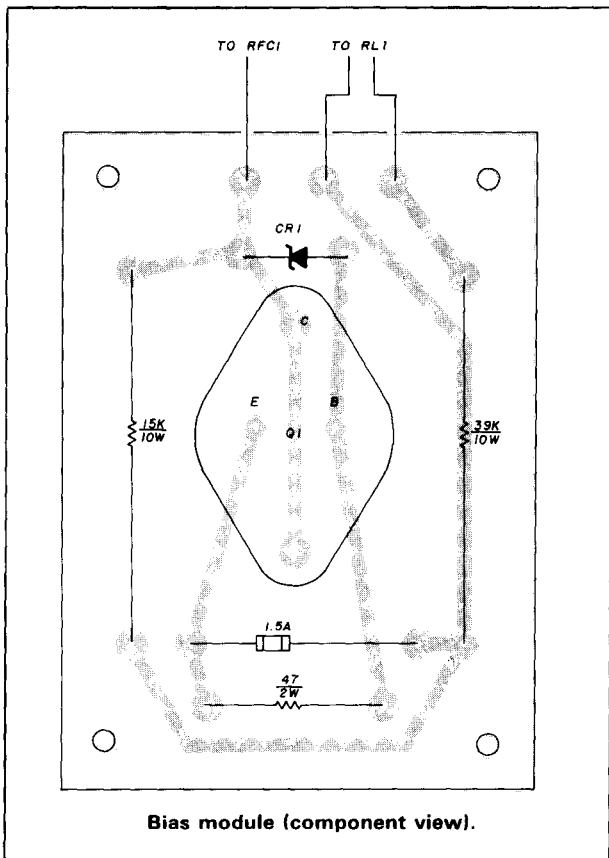

# 50 dB GAIN

## OVER A 1/4 WAVE WET NOODLE!

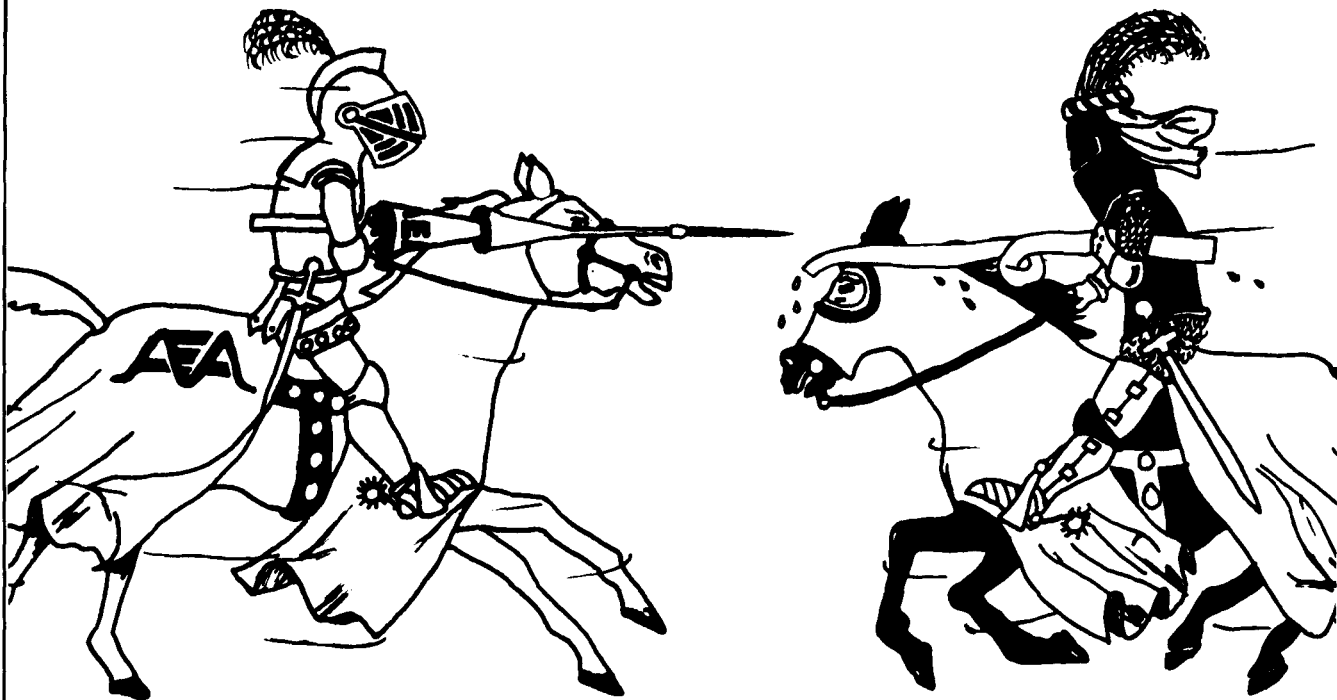

It sounds ridiculous...doesn't it? Amateur Radio advertising is not exempt from exaggeration. When facts are distorted by fabrication you may be induced to buy a product that ultimately is incapable of meeting the performance claimed by the manufacturer. Caveat Emptor (buyer beware)!

The **AEA IsoPole™** antenna has 3 dB gain over a dipole in free space. This is an honest and supportable claim. Yet other manufacturers claim as much as a 7 dB gain for their antennas using no reference standard or a 1/4 wave antenna as reference. The 1/4 wave is not a recognized reference used by **reputable** antenna engineers because it is most difficult to properly decouple in a repeatable fashion.

The **IsoPole** antennas offer the **maximum gain attainable** for the length of antenna. This is a bold statement and one we know we can stand behind!

For any linear array antenna to outperform the **IsoPole** by 3 dB or more on-the-horizon gain, it would have to be at least 20 feet long! Anything less and you can bet that advertising deception is being used.

Before you buy a VHF or UHF base station antenna, get some good **honest** facts about VHF antenna design. Send for your **FREE**

copy of "Facts About Proper VHF Vertical Antenna Design" by Professor D.K. Reynolds, K7DBA. You'll be glad you did.

In the meantime, we would like to expose you to some of the comments we have received from customers that are using the **IsoPole**.

**Seattle, WA** — Compact & easy to install, quality & keeps XYL happy -looks good!!

**Half Moon Bay, CA** — Found repeaters I only heard about before from my QTH — Excellent. Amazed at light weight and low cost...

**Sturgis, SD** — The **IsoPole** Antenna has exceeded my expectations.

**Lumberton, NC** — You really do what you say! The best 2 mtr. antenna I have ever owned!

**La Habra, CA** — Hooked up today, and it was a perfect match throughout the entire band. For the money, you can not go wrong.

**Tok, AK** — Truly a fine antenna, working better than the five element yagi it replaced.

**Sacramento, CA** — Assembly was remarkably easy, I needed an efficient, low profile antenna & your product fit the bill to a "T".

**Warsaw, IND** — AMAZED!!! Antenna ground mounted on required mast & outperforming a (R.R.) at 55' on top of tower.

**Loris, SC** — I'm a commercial radio salesman, and the **IsoPole** is THE antenna I recommend.

**Seattle, WA** — Works well — excellent. Had (R.R.) at 80'. With the **IsoPole** at 20 ft. I now hear repeaters and simplex I never heard with (R.R.) The **IsoPole** will soon be at 80'.

**Freehold, NJ** — It is everything your ad says and more.

**Great Neck, NY** — Amazing difference between (R.R.), 10 db or better, raise rept. never heard before — SUPER, 73 and thanks.

**Richfield, OH** — Works extremely well, broke a repeater at 100 mi using 150 mw !

**Vernon, TX** — (The dealer) said the antenna WAS THE BEST ON MARKET and I AGREE! IT IS AN EXCELLENT antenna & works to specs -Thanks.

Prices and Specifications subject to change without notice or obligation.

# AEA

## Brings you the Breakthrough!

Henry Radio stocks and displays the most complete line of RTTY, AMTOR, printers and peripherals, all available for "hands on viewing". Veterans in RTTY, George Sanso (AB6A) and Boyd Crawford (K6RD) have set up a comprehensive display of RTTY AND AMTOR sending and receiving units that are actually "on the air". Stop by if you're in the area or call or write for literature and information. Henry Radio is a specialist in all types of teletype equipment, including commercial applications.



# Henry Radio

2050 S. BUNDY DRIVE  
LOS ANGELES, CA 90025  
(213) 820-1234

TOLL FREE OUTSIDE CALIF. (800) 421-6631

931 N. Euclid, Anaheim, CA 92801 (714) 772-9200 • Butler, MO 64730 (816) 679-3127

is accomplished by closing the output relay RL2 slightly before the input relay RL1.

The R1-C1 combination, shown in **fig. 6**, causes RF relay RL1 operation to be delayed with respect to RL2.

I checked the timing by applying a small voltage across the contacts of both RL1 and RL2 and watching the voltages on the scope as the amplifier was keyed up. The output relay RL2 closes approximately 25 milliseconds before the input relay RL1. The timing constant provided by R1-C1 is subject to change depending upon the type of relays used for RL1 and RL2.

### lead filtering

All control and power leads entering or leaving the RF deck are filtered. This is accomplished through the use of small coils made by winding 10 turns on a 1/4-inch (6.35 mm) diameter ferrite rod. A bypass capacitor is included on each coil to ground. Locate each filter as close to the rear panel as possible.

Also, feedthrough capacitors are used to filter all leads from the under chassis RF section of the amplifier to the front section meter compartment (see bottom view of the amplifier). All circuits that are sensitive to RF are mounted in this front compartment.

### Pi-L tank circuit design

The tank circuit uses the popular Pi-L design for two reasons. First, a Pi-L gives approximately 15 dB better attenuation of the second harmonic over a more conventional Pi design. Secondly, a Pi-L allows use of a lower value plate tuning capacitor for the circuit.

The design parameters for the Pi-L circuit are provided in **table 1** (see also reference 3). The values shown in **table 1** are for a plate impedance of 1200 ohms.

#### plate impedance

$$= \text{plate voltage} / (1.57 \cdot \text{plate current})$$

$$= 2250 / (1.57 \cdot 1.2) = 1194.3$$

Because of a limitation of 500 pF for the plate tuning capacitor C1, the design for 160 meters is for a plate impedance of 2500 ohms. This translates to 570 mA plate current at 2250 volts or 1289 watts input. This provides about 700 watts output. I felt that this was sufficient power. If full power is desired on 160, some method of adding additional capacitance is needed.

Several coils are required to obtain the desired inductance. Specifications for these coils are contained in **table 1**. Note that the 160 meter and L coils are wound as toroids for compactness. Also, the self-shielding characteristics of the toroids help especially in isolating the L coil from the rest of the tank circuit.

It has become apparent to me that the one place most Amateurs feel uncomfortable is designing and installing the tank circuit in an amplifier. There always seems to be uncertainty about where to tap the coils

to achieve the desired design no matter how many times you do it.

I first use a Heathkit impedance bridge to determine the approximate capacitance at various settings of the tuning knobs. I then take a high-tolerance fixed capacitor and connect it in parallel with the tank circuit at different points to determine approximate inductances of the coil set. This is done with the coil set in place in the amplifier, but with the plate and load tuning capacitors disconnected. The tubes are also re-

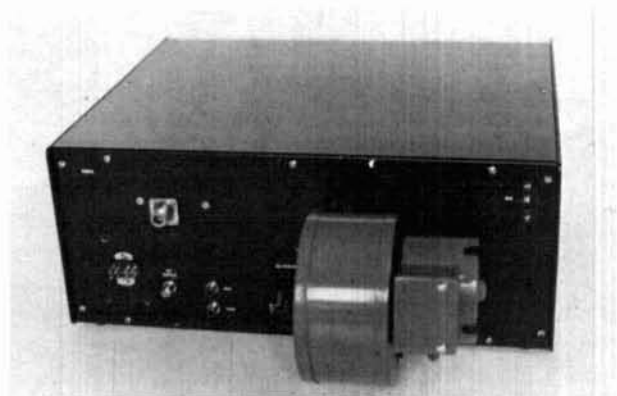

Rear view of amplifier shows Dayton 4C004 blower.

table 1. Pi-L tank circuit values.

F(MHz)	C1	C2	L1	L2	Q
1.8*	462	2121	22.02	8.90	13.1
3.5	469	1443	6.25	4.45	13.4
7.0	235	656	3.23	2.44	12.4
14.0	116	320	1.65	1.24	12.2
21.0	77	213	1.10	0.83	12.2
29.7	54	146	0.80	0.60	12.0

\*R<sub>L</sub> = 2500 ohms I = 570 mA or 1289 watts input  
(1200 ohms for all other frequencies)

#### Coil description:

28 MHz - 3/16 inch tubing; 3-1/2 turns with 1-3/4 inch diameter

21 to 3.5 MHz - 3/16 inch tubing; 14 turns with 2-3/4 inch diameter

taps: 21 MHz - 1-1/2 turns  
14 MHz - 3-1/2 turns  
7 MHz - 7-1/2 turns  
3.5 MHz - 13-1/2 turns

1.8 MHz - toroid; 3 × T200-2s covered with fiberglass tape; 26 turns

#### L-coil

28 to 21 MHz - No. 12 tinned wire; 1-1/8 inch diameter, 5 turns

taps: 28 MHz - 3 turns  
21 MHz - 5 turns

14 to 1.8 MHz - toroid; 2 × T200-2S covered with fiberglass tape; 17 turns

taps: 14 MHz - 2 turns  
7 MHz - 6 turns  
3.5 MHz - 9 turns  
1.8 MHz - 17 turns

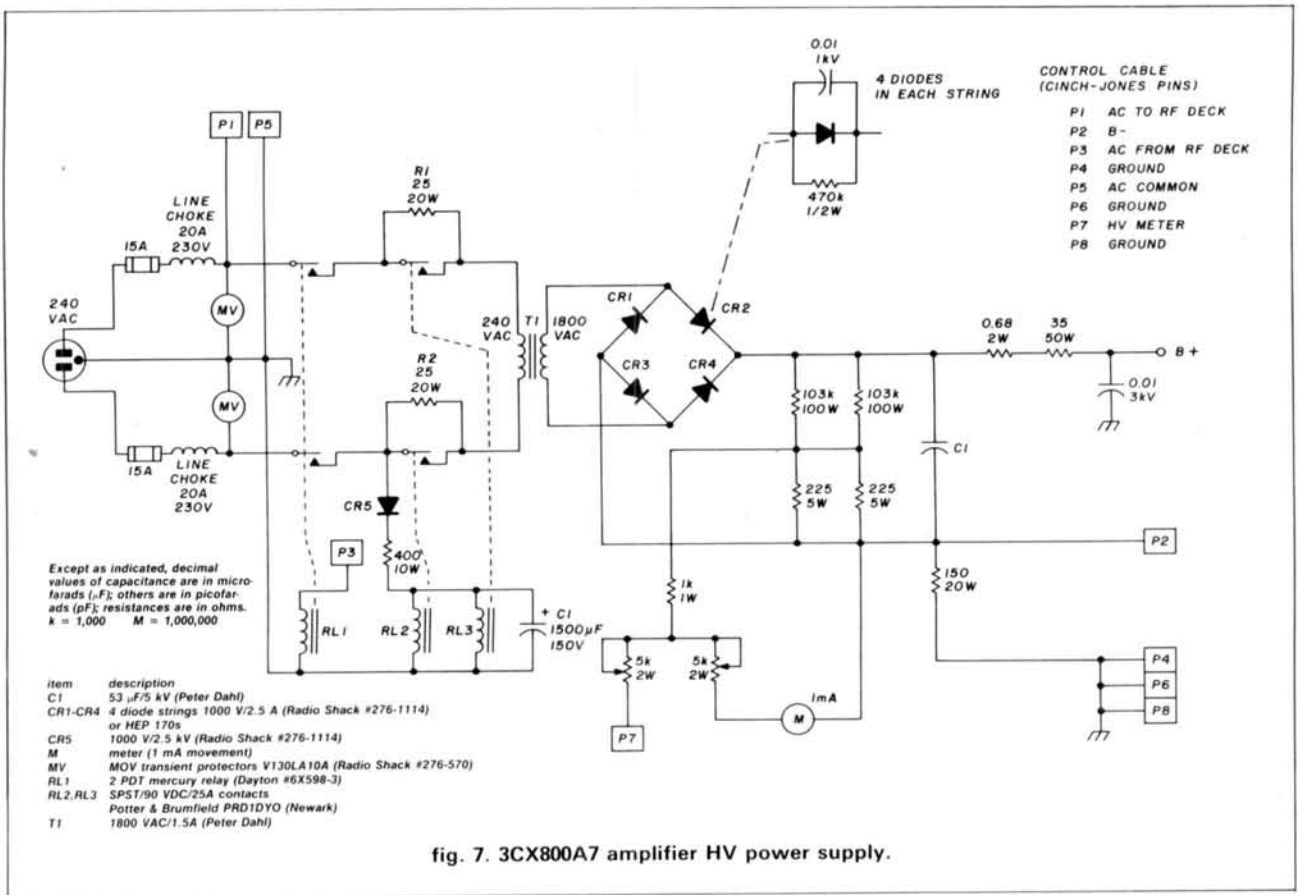
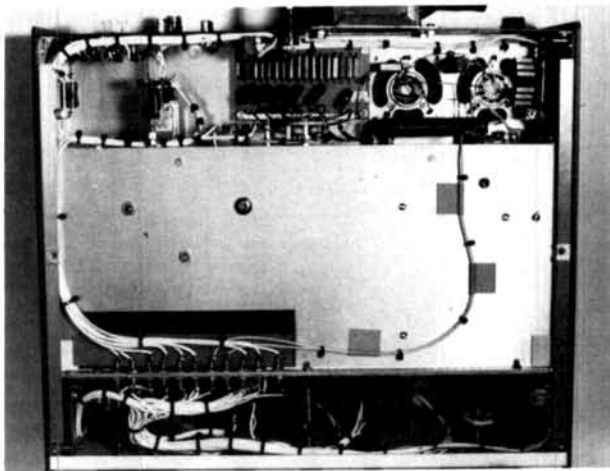

fig. 7. 3CX800A7 amplifier HV power supply.



Bottom view: all leads enter front compartment through 0.001/500-volt feedthrough capacitors.

moved. The frequency is determined by measuring the circuit resonance with a grid dip meter. The frequency ( $f$ ) is used in the following formula to calculate the inductance:

$$L = (10I^2)/(4\pi^2f^2C) \quad (1)$$

The inductances required are listed in table 1.

The next step is to put a 50-ohm carbon composition resistor on the output of the tank circuit to simulate an antenna load. Then set the tuning capacitors at the design values for the band being considered, allowing approximately 12 pF for tube interelectrode capacitance. Using the grid dip meter, locate the tap on the coils to obtain resonance of the circuit. The approximate setting was determined by measuring the inductance at various points with the fixed capacitor, earlier.

This method of finding where to tap the coils is effective. In operation, the setting of the tuning capacitors is almost exactly where I had predicted, using the procedure described above.

I recommend that you go through this procedure even though I have presented, in table 1, a design complete with taps. Variations in physical layout of the inductors and stray capacitances unique to any single amplifier could affect the exact tap settings in the Pi-L tank circuit.

## input network

The input network is designed for a  $Q$  of 1. The network, ganged to the main bandswitch, provides a separate pi-network section on each band. Table 2 summarizes the component values for each pi-section.



# Attention Moonbouncers and Satellite Communications Enthusiasts

## Introducing New Ultra High Performance Antennas from KLM Electronics, Inc.

KLM Electronics is fueling the Moonbounce and Oscar 10 revolution with Antenna Equipment that delivers truly Out-of-This-World performance.

For the Moonbouncer, our New 2M-16LBX is designed to be the highest gain 2 meter antenna available on the market today by more than a full db, making the 2M-16LBX an outstanding performer as a single antenna or in Moonbounce (EME) arrays.

The New 432-30LBX follows the same pattern as the 2M-16LBX, and soon will become the industry's standard of comparison.

Featuring straight forward construction, and an innovative tapered boom that greatly reduces windload and adds strength and durability. Virtually unbreakable, insulated, 3/16" rod parasitic elements are anchored through the boom to insure years of trouble-free performance.

For the satellite enthusiasts, the 2M-22C high gain 2 meter, circular polarized antenna, features the same rugged construction and total flexibility as our very popular 2M-14C with a 2db increase in gain.

Four or more 2M-22Cs make an excellent array for Moonbounce (EME) by eliminating Faraday fading.

Fiberglass/aluminum stacking frames are available as well as 2 and 4 port power dividers and phasing harnesses to optimize the performance of these type arrays.

Watch for our new elevation drive system coming soon.

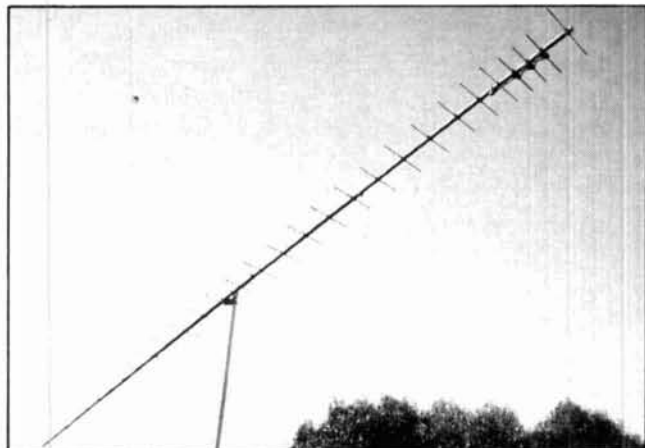

### 432-30LBX

BANDWIDTH .....	430-440 MHz
*GAIN .....	17.3 dBd
BEAMWIDTH .....	(E) 19°, (H) 20°
FEED IMP .....	50 ohms unbal.
BALUN .....	included
BOOM LENGTH .....	21 ft. 11 in.
F/B .....	20 dB F/S
VSWR .....	1.5:1
WINDLOAD .....	1.71 sq. ft. (max.)
TURNING RADIUS .....	12 ft. 4 in.
WT. (lbs.) .....	9 lbs.

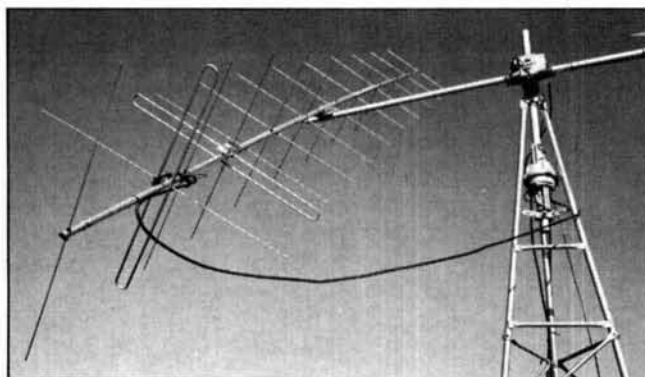

### 2M-22C

BANDWIDTH .....	144-148 MHz
*GAIN .....	13 dBd
BEAMWIDTH .....	(E) 32°, (H) 32°
FEED IMP .....	50 ohms unbal.
BALUN .....	(2) 4:1 coaxial
BOOM LENGTH .....	19 ft. 1 in. (tapered)
VSWR .....	1.5:1
WINDLOAD .....	1.85 sq. ft. max.
ELLIPTICITY .....	± 1.5 dB max.
CIRCULARITY SWITCHER .....	CS-3 included
WT. (lbs.) .....	11 lbs.

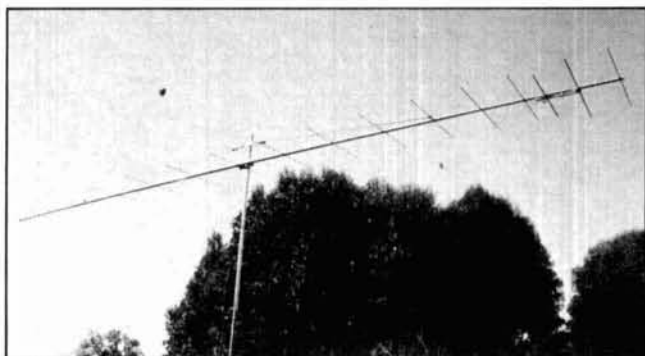

### 2M-16LBX

BANDWIDTH .....	144-146 MHz
*GAIN .....	(144 MHz) 14.5 dBd
BEAMWIDTH .....	(E) 26°, (H) 29°
FEED IMP .....	50 ohms unbal.
BALUN .....	4:1 coaxial, 2 KWPEP
BOOM LENGTH .....	28 ft. 1 in. (tapered)
VSWR .....	1.5:1
WINDLOAD .....	(H) 1.75 sq. ft. (V) 2.44 sq. ft. max.
WT. (lbs.) .....	10 lbs.
TURNING RADIUS .....	15 ft. 5 in.

See the complete line of KLM antennas and equipment at your local dealer, or write for our catalog.

\*To provide a more accurate and consistent gain figure, performance of this KLM antenna has been carefully measured and correlated in accordance with National Bureau of Standards Note #688. This gain figure may appear somewhat conservative when compared with others commonly found in conventional industry literature and based on older, less exacting rating methods.

**KLM** electronics, Inc.  
P.O. Box 816  
Morgan Hill, CA 95037

table 2. RF input network.

F(MHz)	C1*	C2*	L( $\mu$ H)	No. of turns (No. 20 wire) <sup>†</sup>
1.8	1700	642	2.75	22
3.7	827	312	1.34	15
7.1	428	162	0.69	11
14.1	216	82	0.35	8
21.2	144	55	0.23	6
28.5	107	41	0.17	5

\*Use standard values near these theoretical values. Anything close to table values is OK since the  $Q$  is so low.

<sup>†</sup>Coils wound on T68-2 toroid cores.  $Q = 1$ .

The coils are wound on T68-2 toroid cores. Input impedance for a pair of 3CX800A7s is approximately 29 ohms. The input network is important not only for impedance matching for the exciter but also to minimize distortion products.

Fine tuning of the networks can be accomplished by either spreading or compressing the coil turns on each core for minimum SWR on each band, respectively. Exact replication of the network from **table 2**

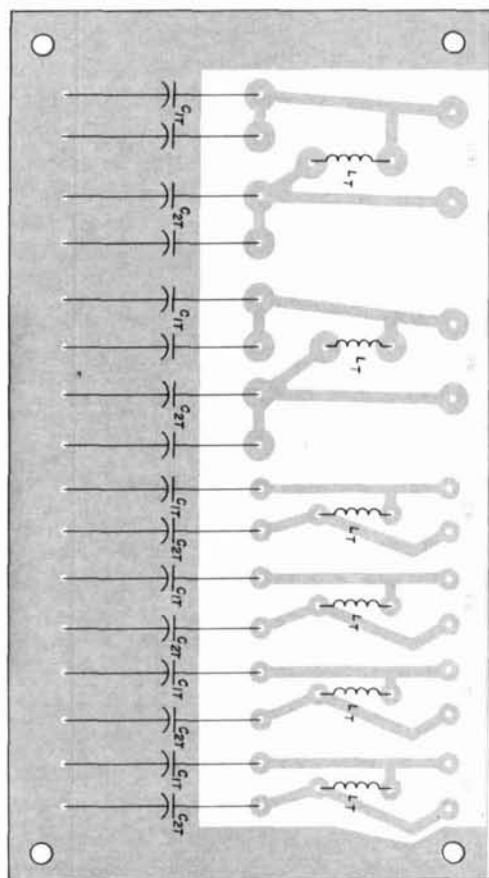

RF input (component view).

may still require some small adjustment due to variations in component tolerances and differences in physical layout.

The network is built as a module on a separate PC board. A board layout has been provided.

## cooling

Sufficient cooling is essential in any high power amplifier.<sup>5</sup> The 3CX800A7s require forced-air cooling to maintain the anodes and seals of the tubes at safe operating temperatures.

The specifications for cooling are summarized as follows:

5000 feet above sea level		
dissipation (watts)	flow rate (cfm)	water pressure (inches)
400	7	0.10
600	14	0.23
800	23	0.57

Refer to the 3CX800A7 technical sheet<sup>4</sup> for more information on cooling at different altitudes.

The blower used in this amplifier is a Dayton model 4C004 which is capable of supplying 45 cfm at 0.4 inch static pressure. The operating speed of the blower is 2880 RPM, which is slow enough to assure relatively quiet operation.

To obtain the legal 1500 watts output requires that the amplifier run at approximately 2500 watts input assuming 60 percent efficiency. This means that the amplifier is dissipating about 1000 watts which is well below the capabilities of the tubes.

The blower mounts on the rear panel of the amplifier and blows air into a pressurized chassis. The air vents up through the tube anodes and out the top of the cabinet. I plan to eventually make a duct flange to mount in place of the blower on the rear panel and remote the blower where it can not be heard. Flexible hose will duct the air from the remote blower to the amplifier.

## high-voltage power supply

One key to optimal performance of any amplifier is the power supply. It takes a supply that not only holds regulation under maximum current draw but also can supply the needed current. This translates to a quality transformer and plenty of filter capacitance. This is the area in which many commercial amplifiers fall short.

The circuit for the power supply is shown in **fig. 7**. The supply operates off of 240 VAC and incorporates a step-start circuit. When the HV switch is pushed on the front panel of the amplifier (assuming the warmup time delay has expired), 110 VAC is returned to the power supply to actuate the mercury plunger relay, RL1. This sends 240 VAC to the HV transformer through the dropping resistors R1 and R2. This avoids

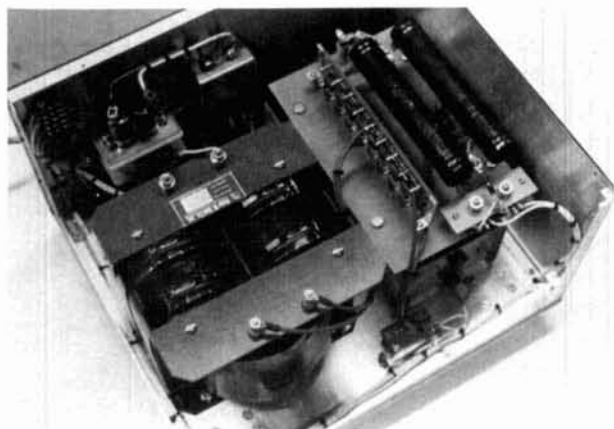
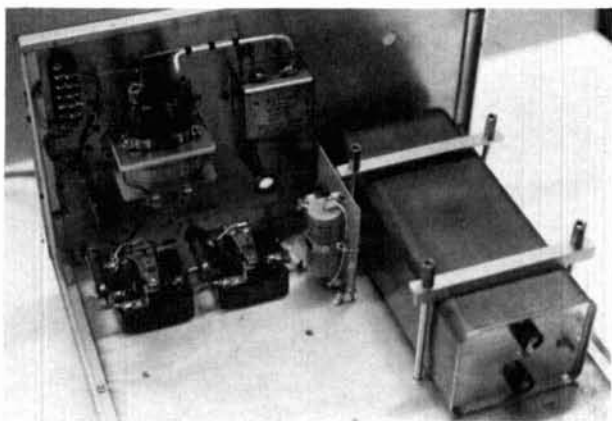

2500-volt high-voltage power supply. Cabinet is constructed from 1/8-inch aluminum panels joined with 1/2-inch angle stock.

a current surge in the supply to charge the 53  $\mu\text{F}$  filter capacitor, C1. A surge could damage the diode bank. After approximately 2 seconds, relays RL2 and RL3 actuate to short out resistors R1 and R2 thus turning the HV supply on to maximum voltage.

The 2-second delay is accomplished by the time constant set up by R3 and C1. 110 VAC is rectified using diode CR5 and proceeds to charge capacitor C1. When the DC voltage on C1 reaches approximately 60 VDC, the DC relays RL2 and RL3 close (relays RL2 and RL3 have 90 VDC coils). This takes about 2 seconds.

Metering is accomplished across the voltage divider created by the 103K bleeder resistors and the pair of 225 ohm resistors. This drops the voltage in the control cable to the amplifier to approximately 5.5 volts. A voltmeter is also included in both the RF deck and power supply cabinets. Note that the meter calibration pots must be adjusted together since they affect one another.

The plate transformer used in the HV power supply was supplied by the Peter Dahl transformer company. A 2.8 kVA CCS hypersil unit is designed specifically for a pair of 3CX800A7s; the unit, now a stock item, is available at a reasonable price. Under no-load con-

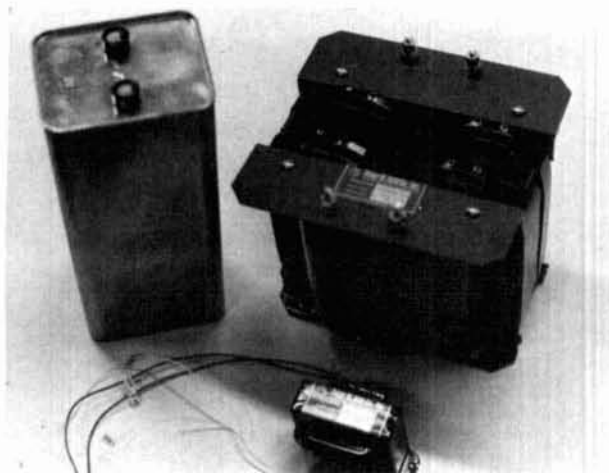

Custom plate and filament transformer, 53- $\mu\text{F}$  filter capacitor. (Available from Peter Dahl Co., Inc.)

ditions, the supply provides 2520 volts. Under a load of 1.2 amperes, the transformer output voltage drops to about 2300 volts! If you want the most out of an amplifier like this one, you need a power supply with a transformer of this high quality.

Peter Dahl also stocks a filament transformer for a pair of the 3CX800A7s (13.6 volts at 3.0 amperes). Both the filament transformer and the plate transformer are well worth the investment. At the time of this writing, Peter Dahl also stocked the 53  $\mu\text{F}$  filter capacitors rated at 5 kV.

### concluding remarks

Building around the 3CX800A7s is a real pleasure. Their compactness and low voltage requirements open up a wide range of projects for compact amplifiers that do not have to sacrifice power capability. The thing that makes the tubes unique is that they are designed for full power operation up to at least 350 MHz.

My thanks to those who contributed so much to this project: Rich Rosen, K2RR, Bill Orr, W6SAI, Dan Redman, K8DR, and Peter Dahl. And last and most important, Jim Garland, W8ZR, who taught me how to build.

### references

1. Jerry Pittenger, K8RA, "8877 Modular Linear Amplifier," *ham radio*, January, 1981, page 12.
2. Jerry Pittenger, K8RA, "A Structured Engineering Approach to the Design and Construction of Electronic Equipment," *QST*, August, 1983, page 18.
3. Irvin M. Hoff, W6FFC, "Pi Network Design," *ham radio*, June, 1978, page 52.
4. EIMAC Varian, *Technical Data Sheet for 3CX800A7*, document 357655/VA4588, 301 Industrial Way, San Carlos, California 94070.
5. Vaughn D. Martin, "Cooling Semiconductors," Parts 1 and 2, *ham radio*, July and August, 1984.

Turn to page 139 for a complete set of ready-to-use PC board artwork (foil side) for the project described in this article. — Editor

ham radio

# NEW!

# OSCAR 10 Dual Axis Rotor

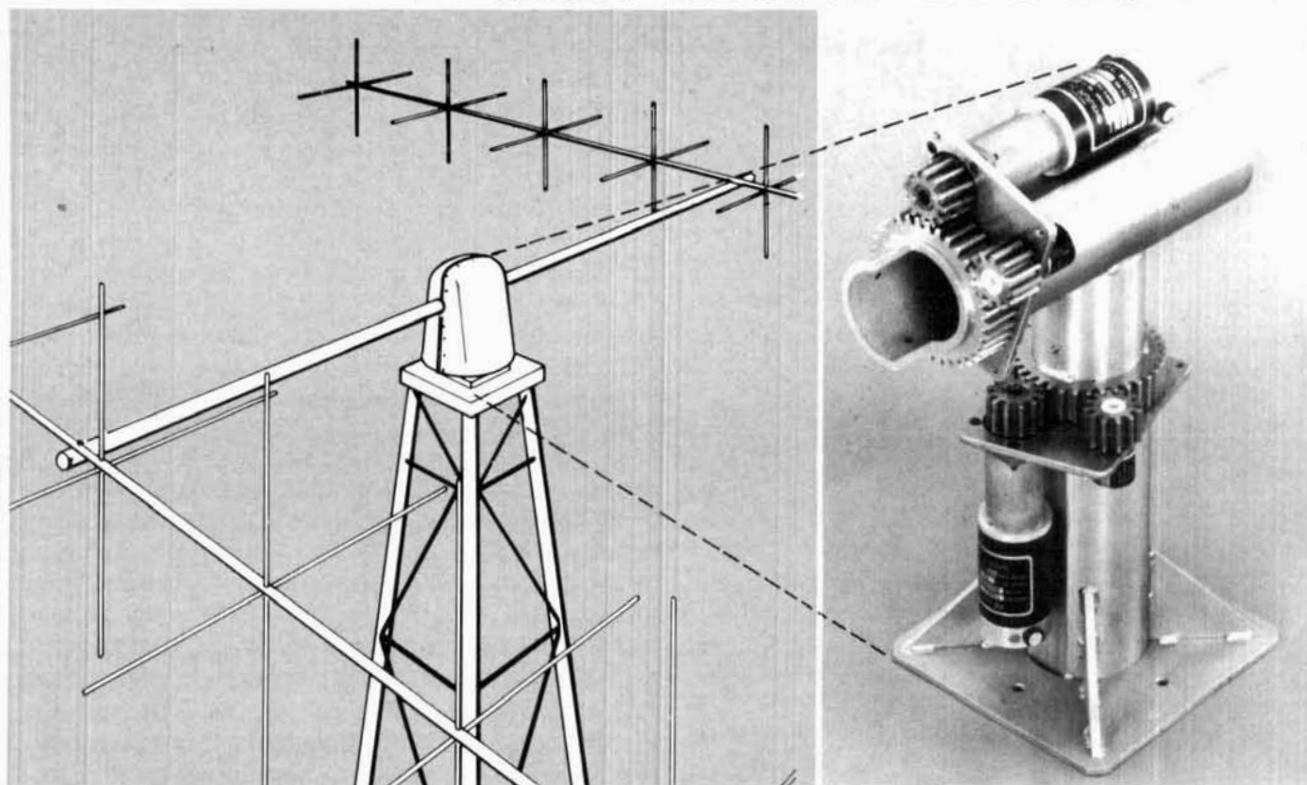

As a leading manufacturer of precision motor drive systems, we believe the newly developed DR10 is the finest dual drive system for satellite antennas. To provide you the highest level of performance and convenience, the DR10 Dual Axis Rotor features:

- **COMPACT CONTROL UNIT WITH SELF CONTAINED AC POWER SUPPLY**
  - **SINGLE DUAL SCALE METER (AZIMUTH/ELEVATION)**
  - **SINGLE 8 WIRE CONTROL CABLE (BELDEN TYPE)**
  - **STANDARD TOWER TOP MOUNTING**
  - **ACCEPTS 1½ INCH ANTENNA BOOM**
  - **SERVICEABLE WITHOUT ANTENNA REMOVAL**
  - **DYNETIC SYSTEMS' HIGH TORQUE, PRECISION GEARMOTORS**
- 
- **LIST PRICE LESS THAN TWO CONVENTIONAL ROTORS**
  - **AVAILABLE FOR AUGUST DELIVERY**

Our DR10 will out-perform any combination of conventional rotors popularly used, and is supplied ready to mount, including the rotor, control unit, and all stainless steel mounting hardware. (less cable)



✓ 135

For immediate ordering information,  
individuals and dealers call or write

**612-441-4303**

**DYNETIC SYSTEMS**  
19128 INDUSTRIAL BOULEVARD  
ELK RIVER, MN 55330



# junk-box ingenuity: how to buy, use, and recycle surplus electronic parts

Don't throw away  
resistors and capacitors  
— *cook them*

At one time, a well-stocked junk-box was a ham's pride and joy. Parts scavenged from discarded televisions, radios, and record players could be used to build anything from test equipment to transceivers. Using vacuum tubes, 1/2 watt 10 and 20 percent resistors, ceramic disk and dipped mylar capacitors, almost any circuit could be built for use up through 450 MHz.

Today's junk boxes are different; chances are they contain odd parts from scavenged surplus boards or parts bought by mail or as assortments at hamfests. They contain various types of semiconductors, 5 percent tolerance resistors, electrolytic and tantalum capacitors, as well as the old stand-by ceramic disks.

Despite the differences in content, all junk boxes are alike in one regard: by definition, they are where parts are stored for long periods until used. Storage takes a toll on electronic components, although much of it is reversible; before examining this, let's consider the parts themselves.

The average ham always seems to be looking to buy new, prime, MIL-spec parts at hamfest prices. Unfortunately such parts are usually not available to the small buyer at any price, although some manufacturers will sell directly to individuals. As a result we buy blister-packed parts at Radio Shack, or by mail from any number of suppliers. While nearly all of these dealers are reputable, the parts you get may not always be exactly what you originally had in mind.

## what is "surplus"?

Consider, for example, the origin of parts termed "surplus." Sometimes a company accidentally overpurchases some new parts and instead of paying a restocking charge, elects to sell them to a surplus agent; *these are the parts you want*. Sometimes a manufac-

turer discovers that a part from one company — often a semiconductor — works in their circuit, while another company's equivalent doesn't. If no other use for them can be found, they will either be thrown away or sold as surplus. (Since the fault lies within the idiosyncrasy of the design, the parts are usually not returnable.) *These may also be good parts*. An important point to remember is that most large buyers of parts have sufficiently amicable relations with their suppliers to return *good parts* for credit.

There's another end of this spectrum: from time to time a manufacturer buys parts that don't meet specifications, but can't be returned for some reason. *These will occasionally end up on the surplus market*. A component manufacturer, for example, may produce a run of products that is not in "spec." While these are most frequently discarded (although garbage cans are sometimes raided) they may be sold to the surplus market. It has even happened that manufacturing runs of semiconductors have been stolen before testing and culling of rejects can be completed; obviously, you don't want *these parts*.

The surplus boards on the market are of a few basic types:

- those that have lived out their expected life and are now experiencing a high failure rate;
- boards made obsolete by a change in design;
- *seriously damaged and therefore non-repairable* boards (damage can include degradation of critical areas, such as gold fingers; submersion in a solder wave; cuts from a mass lead trimmer; or other actions rendering the board electrically unfixable);
- boards simply overbuilt by a company; now and then a manufacturer will sell boards from inventory to raise some cash.

While surplus boards should not be expected to perform their original design functions, chances are that most of the components on all but the first type listed are usable. Even the unfixable boards rarely have more than a few bad components.

By Bob Lombardi, WB4EHS, 1874 Palmer Drive, Melbourne, Florida 32935

In general, then, there's no telling where "grab-bag" parts come from. They might be old or new, merely extras, or genuine junk. Given the diversity of parts from so many varied sources, it's no wonder that we occasionally build a project and find that it's a bad component that keeps it from working.

Take a clue from industry, then, and test your parts before using them. For ICs this may be impractical, but for many types of transistors, diodes, and, of course, resistors, capacitors, and coils, it is entirely reasonable.

### are they out of spec?

Chances are that if you took out a DVM and tested every one of your  $\pm 5$  percent carbon composition resistors, you'd find plenty of them out of tolerance. In particular, they'd all be on the high side of their marked value, perhaps as much as 7 to 10 percent above it. *Don't* throw them out.

The reason for these high values is something I alluded to earlier: improper storage. Carbon composition resistors are essentially carbon and impurities mixed into a binder and molded into shape. The resultant mixture is hygroscopic — that is, it absorbs moisture, which raises the resistance value. This phenomenon is entirely reversible, if the parts have not been over a flow solder (or through any other high temperature operation) while loaded with moisture.

The importance of this consideration depends on the intended use. With the exception of precise RC timing circuits, digital circuits are quite forgiving of resistor values. Analog circuits can be fussier, especially those (such as audio filters) requiring balanced parts or matched values. Most other circuits are less particular. In designing homebrew circuits, you frequently make up for these parts by various means, making the actual value, even if it is "wrong," the design value!

If you need to reverse the problem — i.e., *lower* the values — heat the parts to about 200 degrees F (93.3 degrees C) for a period of time appropriate to the size of the part: 25 hours for 1/8 watt, 50 hours for 1/4 watt, 75 hours for 1/2 watt, 130 hours for 1 watt and larger. If running your oven at 200 degrees for 50 hours or more is inconvenient or too expensive, you can construct a plywood box, line it with fireproof insulation, and add a light bulb or two for temperature control. Some experimenting is necessary for a controlled temperature, but I've seen similar boxes used by small companies for many purposes.

If you can't control the temperature accurately, err on the side of too cool rather than too hot; water-logged parts heated beyond the boiling point of water will explode like popcorn. Using lower temperatures will necessitate leaving the parts in longer; just how long can be determined by removing parts from time to time and checking values.

### handling capacitors

Manufacturers of ceramic capacitors also recommend a heat soak of a day or two at 200 degrees F prior to critical value measurement, although I've never seen a problem with this in industry. One manufacturer recommends heat soaking at 125 degrees C for 4 hours or 150 degrees C for 1/2 hour. This "de-ages" the part to its original value and effectively begins its life anew.

Electrolytic capacitors deform with time as a result of a breakdown of the dielectric layer, and should be reformed before use. This is done by applying the rated voltage to the part for 30 minutes through a current-limiting resistor; 1 K ohm is adequate for up to 100 VDC capacitors. *Let the part "rest" for a day at room temperature.*

The small aluminum electrolytic capacitors popular today may not be much of a bargain if garnered from surplus boards. There are two reasons for this: first, they have a rated life of only 3 to 5 years, if run constantly; second, cleaning these capacitors in hot vapor degreasers will cause premature failure if the parts are not sealed with epoxy over the rubber seal plug on the cap. Of course, because you never know how used parts were handled, you'll have to decide whether to use them or not.

Tantalum, silver mica, polyfilm, and most other capacitors tend to be more stable in storage if their hermeticity is good. In general, if a capacitor is so damaged that the plates are visible, it should be thrown out. Minor chips and cracks may not matter; obviously no electrolytic should be used if its case is punctured or badly dented.

### active devices require special handling

Transistors, diodes, and ICs in epoxy packages are quite rugged, but only if the seals are good. Beware of ceramic or glass packages, which can have hairline cracks.

Enough has been written about static damage that all hams should be aware of it. But less widely known is electrical overstress (EOS) due to a static field, rather than a discharge. This causes operation to degrade gradually, resulting in "flaky" operation (subtle timing errors that occur intermittently, some "soft" RAM failures, and so on) until the system degrades to failure. The only solution to this problem is prevention; with parts bought from anyone other than the manufacturer, there can be no guarantee that electrical overstress has not occurred.

By the way, don't think that this problem is only found in CMOS or MOSFETs. All semiconductor families, including bipolar, have been shown to be degradable by low-level fields of less than 1000 volts.

# Announcing DMM confidence

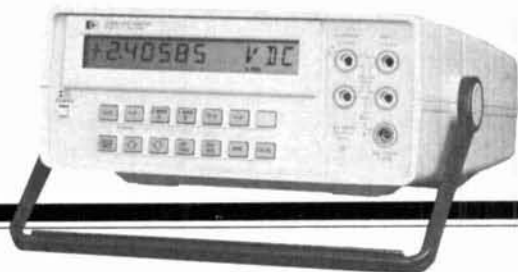

Our figures are in. The HP 3468A DMM reliability numbers indicate over 50,000 hours MTBF (Mean-Time-Between-Failure). Order now (\$750\*) and have one in your hands in just two weeks—that's fast delivery for this 5½ digit DMM that measures dc and ac voltage and current, and two- or four-wire resistance with basic 0.007% accuracy. And, when needed, electronic calibration (no pots to adjust) is easy. You can even order a battery pack (\$125\*) for full portability.

Order this outstanding bench DMM today and we'll also send you information on how to integrate it into your own low-cost measurement system. Call your local HP sales office listed in the telephone directory white pages. Ask for the electronic instruments department.

\*U.S.A. price only.



**HEWLETT  
PACKARD**

19811310

(Actually, once you've read some of the literature available on this topic, you begin to not want to handle semiconductors unless you've strapped yourself to a conductive table top with No. 2 battery cables.)

If you've measured parts and found them to be well out of spec, it may pay to consider the accuracy of your measuring device. Your meter (DVM, cap meter, LCR bridge, or other instrument) also has accuracy tolerances, and they can overlap with the part being measured. If your meter is rated  $\pm 3$  percent, for example, and is running at the high end of its tolerance, any parts that are only 2 percent higher than their rated value will appear to be 5 percent above, and thereby possibly out of spec. It's no wonder that calibration is so highly stressed in high quality operations!

Yet another factor is test method. Consider a common case: that hypothetical DVM you're using probably applies about 1 to 1.5 volts to a resistor during ohm measurement, and reads the current flowing in the circuit. With low value parts, such as those of 10K or less, this is fine; assuming 1.5 volts, the current being measured is 150 microamperes. With parts over 100K, say 1 megohm, the current is 1.5 microampere; this is somewhat harder to measure accurately, especially the detection of small differences in current. This is one reason why exacting specifications for resistor tests call out higher voltages for measuring larger value resistors.

Although this article might seem to emphasize problems — first telling you to measure your parts, then urging you to doubt your results — that's not at all my point; what I'm suggesting is that in order to buy parts intelligently, it helps to know where they came from and what to do with them when problems arise.

It seems strange to me that homebrewing should be on the decline today; this should be a "Golden Age" of homebrewing if there ever was one! Why? Just look at what's available! ICs that perform all manner of digital and analog functions are at our disposal, and most are quite cheap. Using reasonable parts counts, we can build circuits capable of performance that was no more than the stuff of dreams in the 1950s and 1960s; in the 50s, who would have dreamed of a 3-terminal voltage regulator! We can even build things more cheaply today than we could then; just look at old issues of the several Amateur Radio magazines, and you'll find that the dollar prices of gear are essentially the same now as they were in the mid-1960s; taking inflation into account, prices have come *down* considerably, while performance has gone *up*.

Keep a well-stocked junk-box, know what's in it, and do your part in restoring the Golden Age of homebrewed gear!

ham radio

✓ 146

## AMATEUR TELEVISION

### ATV TRANSMITTER/CONVERTER

ALL YOU NEED IN ONE BOX



**\$399 delivered**  
TC-1 plus

- **OVER 10 WATTS PEP OUTPUT.** Crystal controlled continuous duty transmitter. Specify 439.25, 434.0, 426.25 standard or other 70 cm frequency. 2 freq. option add \$26.
- **BASE, MOBILE, or PORTABLE.** Use the builtin AC supply or external 13.8 vdc. Do parades, Marathons, CAP searches, etc.
- **TWO VIDEO AND AUDIO INPUTS** for camera, TVRO, VCR, or computer. Wide bandwidth for broadcast quality color video and computer graphics. Standard broadcast subcarrier sound which is heard thru the TV speaker.
- **RECEIVE ON YOUR STANDARD TV SET** tuned to channel 3 or 4. Sensitive varicap tuned TVC-2L downconverter covers simplex and repeater freq. over the whole 420-450 mHz 70 cm amateur band.
- **ATTRACTIVE 10.5 x 3 x 9 CABINET.**

CALL OR WRITE FOR OUR CATALOG or more information on ATV antennas, transmit modules, cameras, etc. or who is on in your area. See chapter 14 1984 ARRL Handbook.

TERMS: Visa, Mastercard, or cash only UPS CODs by telephone or mail. Postal money orders and telephone orders usually shipped within 2 days. All other checks must clear before shipment. Transmitting equipment sold only to licensed amateurs, verifiable in the 1984 call book.

(818) 447-4565 m-f 8am-6pm pst.

**P.C. ELECTRONICS**

Tom W6ORG Maryann WB6YSS



2522 Paxson Lane  
Arcadia CA 91006

✓ 174

# ANOTHER BOOK LOOK FROM HRB

## SWL info

### BEGINNER'S RTTY HANDBOOK by the Editor, RTTY Journal

More than 85 pages of jam-packed information, technical discussions and illustrations for the Radio Amateur starting RTTY operation. This handbook covers RTTY theory, applications, and operation. Includes: discussion of basics (murray code, pulsing, AFSK keying, demodulation methods, mechanical equipment descriptions, loop supplies, keying circuits, and test methods); machine installation and interconnections; adjustment and calibration; printer parts repair and replacement; HF transceiver hook-ups; auto-start; RTTY art; RTTY equipment supply sources. A valuable resource for any level of RTTY interest. ©1982, 2nd Edition.

RJ-BH Softbound \$8.00

### WORLD PRESS SERVICES by Thomas Harrington

Tuning in to the different press services is the best way to keep abreast of all the latest news developments. Hundreds of news service teletype stations operate around the clock from all parts of the world. Stations are listed by time and frequency for easy locating. Also gives you plenty of helpful hints on the ins and outs of RTTY equipment and other "tricks of the trade." ©1983, 4th edition.

UE-PS Softbound \$8.95

### GUIDE TO UTILITY STATIONS — 3-30 MHz

8,000 frequencies, 4,000 different call signs, tabulated in an easy-to-use format. The first part of this book is arranged in an ascending frequency order starting at 3 MHz. Part two is a complete listing of abbreviations commonly used. Part three is comprised of one of the most up-to-date call sign listings along with common frequencies. There also is a complete listing of both Aeronautical and Maritime Mobile Service frequencies. ©1983, 1st edition.

UE-CS Softbound \$12.95

### RADIO TELETYPE PRESS BROADCASTS

Edited by Michiel Schaay

A convenient, easy-to-use listing of 1500 press broadcasts in all languages. This book is divided into two sections to enhance usability. Part one is a time order list of English, French, German, Spanish and Portuguese news bulletins. Part two contains a detailed time and frequency schedule for 56 different news agencies around the world as well as addresses. Foreign news agencies often provide an interesting, different slant to the world's news. Listening to them can provide a unique insight to the state-of-the-world's affairs. ©1983.

UE-PB Softbound \$12.95

### SHORTWAVE PROPAGATION HANDBOOK

Edited by George Jacobs, W3ASK, and Theodore J. Cohen, N4XX

For many hams, radio wave propagation is still a mystery. Realizing this, the authors have prepared a simplified text that could be understood by hams, swl's and engineers alike. Stress has been given to simplified explanations and charts. The authors also detail a simplified method of do-it-yourself propagation forecasting. To assist your forecasting efforts, the book contains a complete listing of the 12 month smoothed sunspot numbers since 1749. Join those who know how to predict when the bands will open to specific areas of the world. ©1982.

CQ-PH \$8.95

## SATELLITE HANDBOOKS

### INTRODUCTION TO SATELLITE TV

by Chris Bowick, WD4C and Tim Kearney, N240

Forty years ago, the most sophisticated piece of electronics in the average home was an AM radio. Today, many homes are set up with state-of-the-art receivers designed to pluck signals from satellites orbiting 23,000 miles in space. Instead of getting into a nuts and bolts approach to TVRO, this book gives you a broad overview of TVRO in general with emphasis on home use. Chapter 1 covers TVRO background and gives a generalized explanation of what TVRO is all about. Chapters 2-4 give you a broad overview of the equipment used to transmit and receive TVRO signals. Three appendices also cover DBS, locating satellites and a glossary of TVRO terms. 1st edition. ©1983 142 pages.

I21978 Softbound \$9.95

### THE SATELLITE TV HANDBOOK

by Anthony T. Easton

Answers virtually any question you might have on satellite TV. This new book gives you a complete overview of the satellite service, how satellites work, what programming is available, who operates the various satellites, networks and stations, how to engineer and install a system, and the legal background of TVRO. For the "homebrewer", there is a section on building your own TV dish and receiver for around \$600. You also get a section about the non-television services from satellites — radio feeds, teletext, news wire and information on DXing international satellites. ©1983

439 pages, first edition

22055 Softbound \$16.95

### VHF-UHF MANUAL

by G.R. Jessop, G6JP

This revised 4th edition is jam-packed with circuits, antennas, converters, cavity amplifiers and much, much more. Practical theory and construction projects cover from 70 MHz to 24 GHz. The chapter on Microwaves has been expanded to 83 state-of-the-art pages. Receiver and transmitters for all VHF and UHF bands are covered in 181 pages. The balance of this book contains information on propagation, tuned circuits, space communications, filters, test equipment, antennas, plus a handy easy-to-use data section. Equipment designed for the British 4 meter band can be adapted fairly easily to the U.S. 6 meter allocation. ©1983, 512 pages, 4th edition.

RS-VH Hardbound \$17.50

### INTRODUCTION TO AND THE OPERATION OF AMTOR

by Phil Anderson, W0XI

Here's a great new book to answer all of your questions about AMTOR, Amateur Teletype Over Radio — It's the error free mode of Amateur communication. AMTOR is a special form of RTTY, radio teletype, that uses a seven bit code and a special operating procedure, TOR, Teletype Over Radio, was first developed for ship-to-shore communications where reliability is an absolute must. AMTOR allows hams to take advantage of this unique technology and benefit from reliable, nearly 100% error free communication. Phil Anderson gives you an easy-to-read description of the basics of AMTOR, how to set up a station, equipment, operating procedures, software and theory of operation. From there it's up to you to get your very own AMTOR station up and running. This is the only book of its kind available today. ©1983, 1st edition, 36 pages.

KT-AMT Softbound \$3.95

### WIND/SOLAR ENERGY FOR RADIO COMMUNICATIONS AND LOW POWER ELECTRICAL SYSTEMS

by Edward M. Noll, W3FQJ

Author Noll's book is your first step towards energy independence. Chapter 1 covers solar energy and photovoltaic converters. Chapter 2 tells how to convert wind power into energy. Chapter 3 deals with the systems required to store the power and how to convert it to 110 volts AC. Chapter 4 discusses how the author has used solar power to run a QRP Amateur station and various other interesting applications. Finally, Chapter 5 deals with the larger practical applications that we may see as future power sources. Take advantage of cheap natural power sources and put them to work. ©1981, 2nd edition, 264 pages.

I21827 Softbound \$12.95

Please add \$2.50 for shipping and handling.

## BRAND NEW

### OFFICIAL ARRL CALL DIRECTORY 1984-85

Brand new, chockfull of all the latest call signs and addresses from the FCC files and compiled by Buckmaster Publishing. 1090 pages of addresses are listed alphabetically by call sign for easy reference and location. Printed on easy-to-read stock. This is a book you should have in your ham shack. ©1984, 1090 pages.

AR-CD84 Softbound \$18.75  
(\$15.75 + \$3.00 shipping)

### IC VOLTAGE REGULATOR SOURCEBOOK WITH EXPERIMENTS by Vaughn Martin

Power supplies have changed quite a bit since the days of mercury vapor tubes. This new book was written to introduce you to modern IC voltage regulators. In depth coverage includes transformers, rectifiers, filters and semiconductors with special attention to temperature compensated zener diodes, bandgap references, avalanche diodes and voltage and current differencing op-amps. You also get plenty of practical projects and experiments. Invaluable as a source book for hobbyists and experimenters as well as professional technicians and electronics engineers. ©1983, 1st edition, 245 pages.

T-1557 Softbound \$11.50

### NORTH AMERICAN RADIO AND TELEVISION STATION GUIDE

Here it is. Brand new and completely up-to-date. This book is a comprehensive listing of all radio and television stations in the US, Canada, Mexico and the West Indies. 14th edition. ©1984.

22296 Softbound \$9.95

### 2ND OP

by Jim Rafferty, N6RJ

The 2nd Op is an indispensable operating aid for all Radio Amateurs. Gives you at the twist of a dial: prefixes in use, continent, zone, country, beam heading, time differential, postal rates, QSO and QSL records and the official ITU prefix list. Every ham needs a 2nd Op. Order yours today. ©1981, N6RJ's 1st Edition

HR-OP SAVE \$2 \$4.95

### RADIOS THAT WORK FOR FREE

by K. F. Edwards

It's not often that you can get something for nothing in this world. This book will tell you how to come as close to it as possible. "Radios that Work for Free" tells you how to build several circuits, each of which will provide you with music, news and entertainment while using only the intercepted power of the station itself. The parts used are inexpensive, or if you are a good scrounger and salvage expert, you'll find most of the parts for free, just as the signals are. Descriptions are amazingly complete. More than just a trip into nostalgia, the book is a lesson in basic radio principles and techniques — and you can dance to the results. 137 pages. ©1977.

HO-RWF Spiralbound \$5.00

### BASEBALL CAP

How about an attractive BASEBALL style cap that has name and call on it. It gives a jaunty air when worn at Hamfests and it is a great help for friends who have never met to spot names and calls for easy recognition. Great for birthdays, anniversaries, special days, whatever occasion. Hats come in the following colors: GOLD, BLUE, RED, KELLY GREEN. Please send call and name (maximum 6 letters per line).

UFBC-81 \$6.00  
(\$5.00 + \$1.00 Shipping)



### I.D. BADGES

No ham should be without an I.D. badge. It's just the thing for club meetings, conventions, and get-togethers, and you have a wide choice of colors. Have your name and call engraved in either standard or script type on one of these plastic laminated I.D. badges. Available in the following color combinations (badge/lettering): white/red, wood-grain/white, blue/white, white/black, yellow/blue, red/white, green/white, metallic gold/black, metallic silver/black.

UID Engraved I.D. Badge \$2.50

# ENGINEERING MAKES THE DIFFERENCE



## Production Expertise And Service Integrity Form The Foundation For Your Long-Term Satisfaction

The fact that the Computer Patch Interface unit by Advanced Electronic Applications, Inc. is known as the best value on the market is no accident. The CP-1 was designed by Al Chandler, K6RFK (PHD-E.E.), an active RTTY user since 1963.

Given a cost per unit budget for the CP-1, Al designed as much performance as possible into the Computer Patch, including a unique new tuning indicator, referred to by one of our customers as the "Dead Eye Dick" tuning indicator. This indicator is ideal for RTTY and CW, in that it is both fast to tune and (within 10<sup>4</sup>Hz) as accurate as scope tuning. It also performs under poor signal to noise conditions in which other indicators provide no useful data.

Al's variable shift tuning was designed to move the space filter center frequency from 2225 Hz to 3125 Hz without changing the bandwidth (by varying the Q of the filter). All this is accomplished using a precision ganged potentiometer to assure proper tracking of the multiple filter stages. We could have used a pot costing a tenth as much by simply using a two-pole filter design, but we feel the advantage of a sharper filter reduces the noise bandwidth significantly and allows the variable shift control to be used like passband tuning for extra elimination of adjacent channel interference.

Some manufacturers are concerned that amateurs might try calibrating their own equipment and, therefore, have used non-adjustable components, which results in sub-optimal performance. Although more costly, trim pots used in AEA equipment allow factory adjustment for performance to design specifications. Competently designed active filter circuits need not be adjusted after leaving the factory; however, for specialized use the owner can easily change filter parameters.

Mindful of the fact that many of our customers are new to RTTY, Al made the CP-1 tuning as forgiving as possible, while providing the most critical operator a piece of equipment in which he could be proud. Even old "pro's" are surprised at the poor signal conditions under which the CP-1 will still provide good copy.

You can now experience the BEST RTTY, CW, and AMTOR offered. Couple the CP-1 with our new AEASOFT™ software packages designed for the MARS, SWL, or amateur radio operator, and you will feel a pride reminiscent of what "made in U.S.A." brought in years gone by. Please do not hold the low price of the CP-1 against us. This is one case where you get much more than you pay for relative to any of the competitive units. For more information send for our FREE catalog. Better yet, see your favorite dealer.

## MIDWEST AMATEUR RADIO SUPPLY

3456 Fremont Avenue, North  
Minneapolis, MN 55412

Store Hours: Mon.-Fri. 9-6, Saturday 9-3

For service call: (612) 521-4662

For orders call: 1-800-328-6365

**AEA** Brings you the  
Breakthrough!

161



# constructing air-wound coils

Build your own  
for high Q, low cost

**For the lack of a proper coil**, a project such as an amplifier, tuner, or antenna, may be slowed down or stopped. If your local supply house doesn't stock coils and if you don't want to order by mail, you can wind your own.

Using this simple technique, professional looking air inductances (fig. 1) 2 to 4 inches (5 to 10 cm) in diameter with wire sizes No. 8 to No. 16, can be fabricated, at a cost of no more than about 25 percent of commercial coils.

## easily obtained materials

This method is based on the use of a wood cylinder commonly called a *mandrel* (fig. 2). Fig. 3 shows the dimensions of wood blocks which will produce a mandrel to fabricate 3-inch (7.6 cm) diameter coils. I have three such mandrels, 2, 2-1/2, and 3 inches (5, 6.4, and 7.6 cm) in diameter. This selection accommodates all my coil needs. Fig. 4 shows the dimensions of a 3-inch (7.6 cm) diameter mandrel, in finished form.

Several choices of wire are appropriate. You can use the bare, soft copper wire (grounding wire) available in many sizes at building supply houses, or plastic covered solid wire stripped of its insulation. Enameled wire works well, but may present a problem if you intend to solder taps on the coil; the enameled insulation is difficult to scrape off. Tinned copper makes especially good looking coils, but while it's easy to solder, it may be difficult to obtain.

The coil supports are glass epoxy board cut into strips 12 inches (30 cm) long, 1/2-inch wide (13 mm)

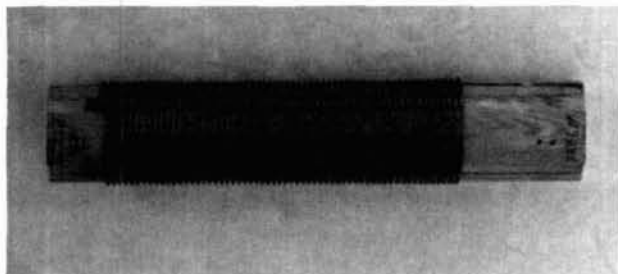

fig. 1. Finished coil on mandrel.

by 1/16-inch (1.6 mm) thick. I use discarded printed circuit board material, which can be cut easily with a hack saw. Just insert the blade of a knife under the copper foil and peel it off. Any remaining holes in the board will be filled with epoxy cement.

Sand one side of the PC board strips to remove the glaze and improve the bond between the cement and board. Do not use plexiglass or equivalent, which will deteriorate with exposure to heat or sunlight.

Other materials needed are 5-minute epoxy cement, kitchen type wax paper, some wood screws, a few rubber bands, and twine or plastic covered hook-up wire, the diameter of which will determine the wire spacing.

## fabricating the mandrel

Fig. 3 shows two blocks of wood held together with wood screws. The screw heads are counterbored deeply enough to prevent interference with the turning operation on the lathe. Place the assembled block in a metal or wood turning lathe on the indicated centers. Shape this assembly into a tapered cylinder — while the tapered dimensions are not critical, tapering *is* necessary — per fig. 4. This is a simple job. If you don't have a lathe, a friend with a lathe should be willing to do this for you.

Grooves are cut using a table saw with a dado cutter of correct width. The insulating strips must fit loosely in these grooves; observe the tolerances shown in fig. 4. Grooves can also be cut with an ordinary blade on the circular saw by setting the blade to the proper depth. Cut one blade width at a time, rotating the mandrel to widen the groove progressively until it is wide enough. Because of the limited space available on its circumference, a 2-inch (5 cm) diameter mandrel can have only three grooves. These cannot cross the diagonal split; if they did, the mandrel would not slide apart. The finished mandrel is a cylinder split diagonally and tapered from one end to the other. It will slide apart freely after the coil has been wound and cemented.

## winding the coil

Take the mandrel apart and insert three layers of wax paper between the two halves. This paper will allow the mandrel to slide apart easily. Put the man-

By Paul A. Johnson, W7KBE, 10817 Brookside Drive, Sun City, Arizona 85351

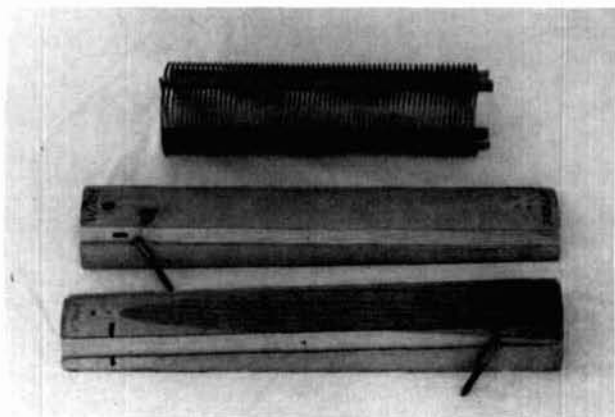

fig. 2. Finished coil with the mandrel removed and disassembled.

drel together with the screws and cover it with wax paper, allowing an overlap of about 1.5 inches (3.8 cm). Lay the glass epoxy strips (or cut epoxy board strips) in each groove, sanded side up, over the wax paper; they should fit in the grooves loosely, with play in the width as well as depth. Slip several tight rubber bands over the mandrel to keep the wax paper and strips in place. Center the strips and paper on the mandrel *lengthwise*.

Calculate the length of wire and twine needed to wind a 12-inch (30 cm) long coil by multiplying the number of turns you need times circumference of the mandrel. While you may not need this much coil, the leftover stock can be used for your next project and it's better to cut a piece too long than too short. Anchor one end of the wire securely, working outdoors if necessary for sufficient work space. Stretch the wire to remove all bends and kinks, then polish the wire with sandpaper for an attractive appearance. The epoxy cement will adhere better to the polished wire than to unpolished wire, and if you have to tap the coil, soldering will be easier.

Bend a hook in the free end of the stretched wire and fasten this hook to the wood mandrel, about 1.5 inches (3.8 cm) from one end with a wood screw. Lay out a length of twine the same length as the copper wire. Then wind the wire and twine on the mandrel tightly, parallel, removing the rubber bands as the winding progresses. The wound wire will hold the wax paper and strips in place. Wind the wire and twine tightly against each other to insure accurate spacing.

After the wire and twine are completely wound, fasten the wire to the mandrel with another wood screw, and remove the twine. Mix and apply only enough 2-part epoxy cement to cover one insulating strip sparingly, with no excess cement on the wax paper. If you've maintained the proper clearances on the wood mandrel, the insulating strip should move freely under the wire. Slide the strip back and forth,

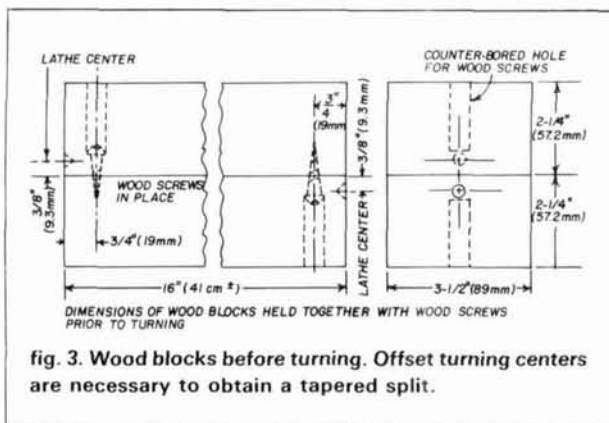

fig. 3. Wood blocks before turning. Offset turning centers are necessary to obtain a tapered split.

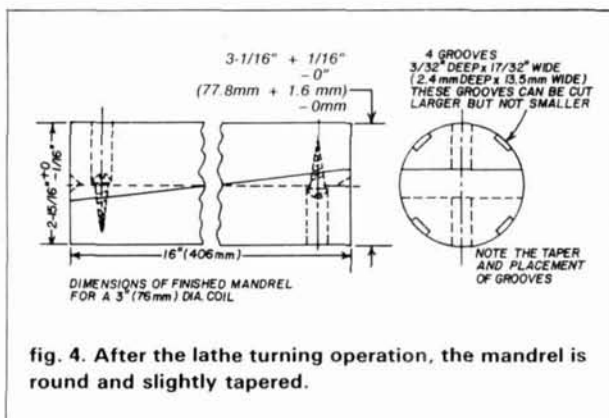

fig. 4. After the lathe turning operation, the mandrel is round and slightly tapered.

distributing the cement evenly between the wire and strip. Let it set for 5 minutes. Cement the other strips at 5-minute intervals. When cementing is complete, set the project aside overnight to allow the cement to harden completely.

## removing the mandrel

Remove all wood screws anchoring the wire and holding the mandrel together. Place the mandrel vertically, larger end down, on the edge of a table. (The table should support the mandrel only up to the edge of the split.) Hit the smaller diameter split end with a block of wood. The mandrel will then slide apart easily. You now have a finished coil.

## the end product

If you feel the finished coil needs more support, another layer of epoxy cement can be applied to each strip. I cement another strip on the coil for mounting purposes; this also makes a structurally stronger coil. In addition to strength and stability, this home-built coil offers high  $Q$  dissipating very little power even at the kilowatt power level. I have used coils built by this method in my trapped dipoles, antenna tuner, and final amplifier, with great success.

ham radio

# COMPLETE YOUR STATION!

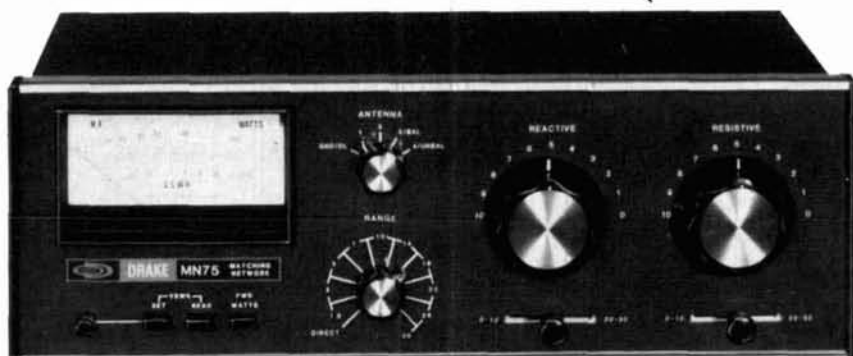

## DRAKE MN75 ANTENNA TUNER

The Drake MN75 matching network will optimize your system performance with a surprising range of features and flexibility. From 1.8 to 30MHz., the MN75 matches balanced lines, coaxial lines, or random wires. (Optional B-1000 balun required for balanced lines.) RF output and VSWR readings are available at the push of a button. The rugged MN75 is rated at 200 watts continuous duty and features antenna switching as well as bypass capability. Get maximum power to your antenna system with the Drake MN75.



## DRAKE SP75 SPEECH PROCESSOR

The Drake SP75 Speech Processor packs the punch it takes to be heard! The SP75 is an RF type speech processor designed to give your signal that needed boost when the going gets tough. Connect the SP75 between your microphone and your Drake TR7 or TR5 — that's all! Front panel switching gives you a bypass option as well as phone patch or tape player input. Special muting circuitry even allows you to operate VOX while using the SP75. The clipping level is adjustable and the LED indicator shows the proper audio input level.



## DRAKE CW75 ELECTRONIC KEYS

A no-nonsense keyer for the '80's: the Drake CW75. Smooth iambic keying (grid block or direct) is at your fingertips with either a squeeze key, semi-automatic "bug", or straight key. 5 to 50 WPM capability with front panel speed control. Built-in side tone monitor with volume control. Operates from an external 7 to 14 volt supply or a nine volt optional internal battery.



## DRAKE P75 PHONE PATCH

Use your station to its fullest! The Drake P75 Phone Patch puts you on the front lines of amateur radio public service. With the P75, your station can be that vital link between the remote location and the folks back home. The P75 is a hybrid patch for use with the Drake 7-line or other transmitter/receiver combinations. Features such as in/out switching and adjustable RX/TX level controls make the P75 Phone Patch the choice you can count on.



R.L. Drake Company • 540 Richard Street • Miamisburg, Ohio 45342 • USA • Phone (513)866-2421 • Telex: 288-017

© COPYRIGHT 1984 R.L. DRAKE COMPANY

# improving amplifier ALC circuits: part 1

## Grid current derived ALC helps upgrade AB<sub>2</sub> amplifier performance

Part One of this article examines current ALC techniques and illustrates methods of improvement. Part Two details several modifications (including ALC) for input matching and tube protection in the compact MLA-2500 amplifier. Editor

Although modern exciters contain adequate ALC circuits, modern AB<sub>2</sub> amplifiers lack truly automatic practical circuits. In this article, several approaches to amplifier-developed ALC are examined and a practical circuit is developed, using a grid current derived sample. This circuit is used in a Dentron MLA-2500 to protect the 8875 tubes from overdrive and grid destruction. Adaptability to other tube types is also discussed.

One of the most important assets of a modern exciter is an ALC circuit that prevents overdrive of the exciter's final and intermediate stage amplifiers. Controlling the drive — or load — helps preserve spectrum space as well as the exciter's output devices.

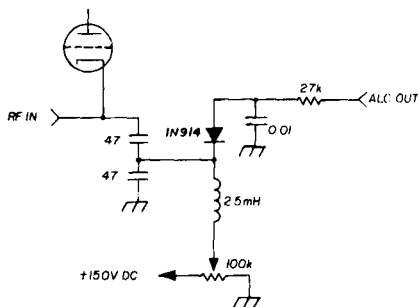

fig. 1. Typical HF amplifier ALC circuit.

Few, if any, modern exciters lack ALC. Forward power, reflected power, final amplifier current, frequency and other parameters are used to set a power output level at which the exciter can operate without distortion or destruction. It is also true that few — if any — modern linear amplifiers have a satisfactory ALC circuit to prevent overdrive from occurring. This is so even though it is as important to control drive to an external amplifier as it is to control the drive to an exciter's final stage.

The term ALC is derived from early Collins nomenclature: Automatic Load Control. Many amplifiers include a circuit such as that shown in fig. 1. This circuit is clearly not automatic, but is based solely on RF input voltage. Such circuits offer protection from overdrive only when adjusted for each set of operating conditions on each band; they also offer no amplifier tube protection. Two important exceptions to the rule are amplifiers that do protect themselves from overdrive and consequent destruction when connected to the exciter's ALC: the Collins 30S-1 and the E.T.O. Alpha 77.

### 30S-1 ALC circuit

An example of true ALC is the circuit used in the Collins 30S-1 amplifier (fig. 2). The 30S-1 is an AB<sub>1</sub> amplifier; any grid current automatically indicates an overdrive condition. A 10K:10K transformer provides DC isolation between the ALC and grid circuits. In SSB service, an AC voltage is developed across the primary and secondary of the ALC transformer proportional to the grid current that flows at the audio frequency (rate) of the incoming signal. A substantial amount of control voltage is available for small values of grid current by using a voltage doubler circuit to rectify the AC voltage present across the secondary of the transformer. Sensing grid current variations is an effective way of preventing overdrive and distor-

By J. Fred Riley, WA8AJN, 1721 Poplar Street, Kenova, West Virginia 25530

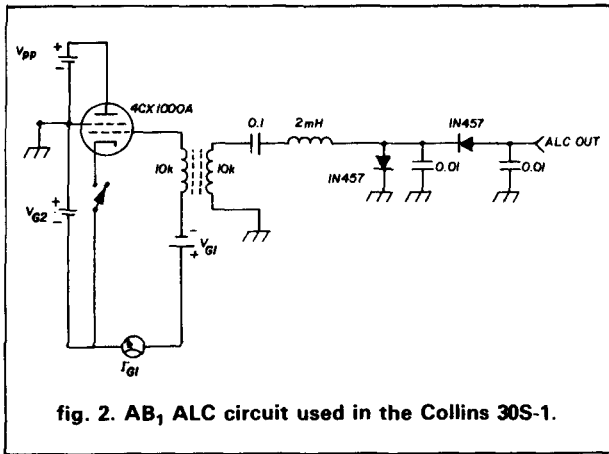

fig. 2. AB<sub>1</sub> ALC circuit used in the Collins 30S-1.

tion in this amplifier. The particular sensitivity of the circuit is achieved by the 10 kilohm impedance of the grid transformer. This high impedance in series with the grid can cause problems if the ALC voltage is not returned to the ALC buss in the exciter. Anyone who has ever heard a 30S-1 being used without the ALC interconnected can testify to the extraordinary bandwidth that results from even minimum overdrive when the grid voltage is subject to dynamic instability.

The 30S-1 circuit is not adaptable to most modern amplifiers in Amateur use. The most common circuits use zero-bias tubes operated in Class AB<sub>2</sub>. Significant values of grid current are necessary and normal. But there is an important analogy: just as the onset of grid current signals an overdrive condition in an AB<sub>1</sub> amplifier, certain fixed amounts of grid current can signal overdrive or dangerous drive levels in an AB<sub>2</sub> amplifier. It is quite possible to destroy a grid by applying drive without plate voltage being present. As the price of tubes soars, protective circuitry based on grid current seems a necessary adjunct for tube preservation alone even without consideration of performance.

E.T.O.\* uses this type of circuit. The Alpha 77 is a modern AB<sub>2</sub> amplifier that has an ALC circuit designed to positively limit the 8877 grid current to 150-200 milliamperes (see fig. 3). Grid current is sensed, amplified, and inverted by the Q204, Q205 circuitry. In operation the negative ALC output voltage serves to limit the grid current to a preset, nondestructive limit even under conditions of mistuning, or worse, no plate voltage. In normal operation 150 milliamperes of grid current represents the upper limit of the tube's linear range.

### modifying an older ALC circuit

The MLA-2500 amplifier ALC circuit shown in fig. 1 is representative of the majority of ALC circuits used in other amplifiers. The lack of protection for the grids of the 8875 tubes offers an opportunity to adapt a circuit that protects against overdrive and potential tube

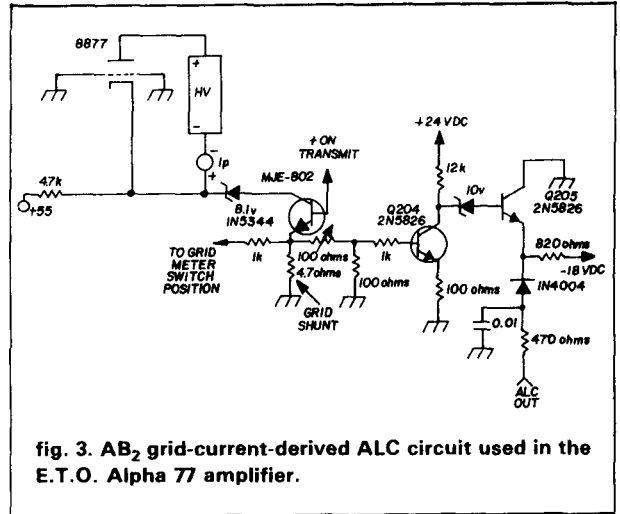

fig. 3. AB<sub>2</sub> grid-current-derived ALC circuit used in the E.T.O. Alpha 77 amplifier.

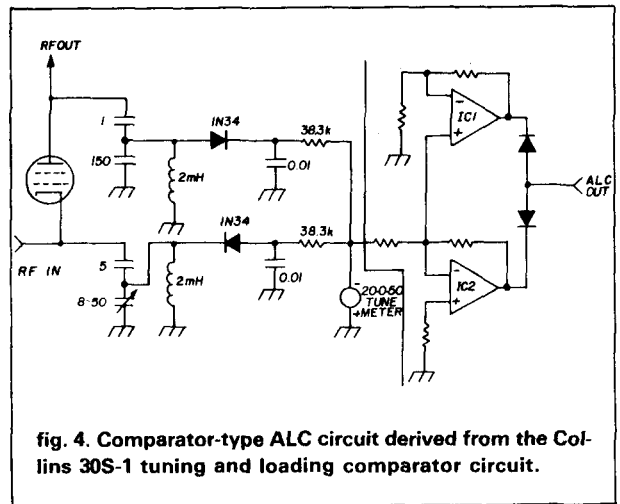

fig. 4. Comparator-type ALC circuit derived from the Collins 30S-1 tuning and loading comparator circuit.

destruction. An added incentive is the fact that it costs as much to replace the final tubes in an MLA-2500 as to buy a used amplifier.

The first circuit I experimented with was based on the tuning and loading circuit of the 30S-1. Fig. 4 shows the comparator circuit which samples both input and output RF voltages to detect nonlinearity resulting from any cause. The use of DC amplifiers to generate a negative going ALC voltage when the comparator output voltage departs from its null seemed initially to be a satisfactory solution. In practice it failed. The impedance is fairly high and stray capacitance and inductance effects were different on each band. In addition, the circuit required correction to provide protection when the mode of operation was changed from SSB to CW which increased circuit complexity substantially. Disabling the circuit was also necessary in order to initially tune up. I soon abandoned this approach.

\*Ehrhorn Technological Operations, Canon City, Colorado.



**NEW!**

# Full Featured - Miniature H/T Power to Go...

FROM  
**MIRAGE**

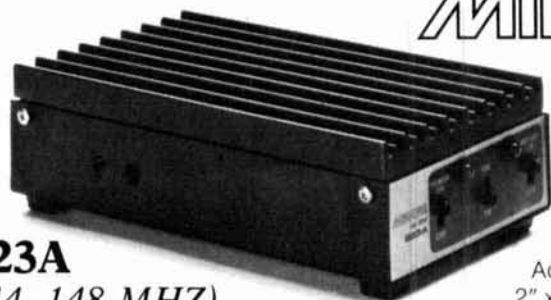

**B23A**  
(144-148 MHz)

- 2 Watts in = 30 Watts out
- Built-in Receive Preamp
- All mode operation (FM, CW, or SSB)
- Automatic Antenna Changeover

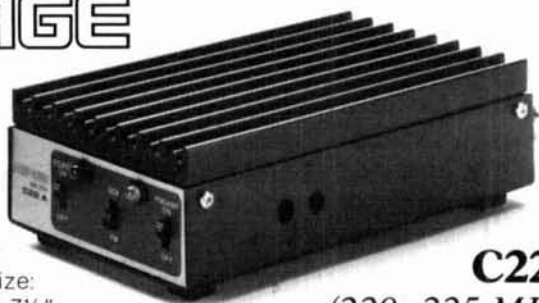

**C22A**  
(220-225 MHz)

- 2 Watts in = 20 Watts out
- Built-in Receive Preamp
- All mode operation (FM, CW, or SSB)
- Automatic Antenna Changeover

Actual Size:  
2" x 3½" x 7¼"

See the complete line of MIRAGE amplifiers  
at your local dealer, or write to Everett Gracey.

**MIRAGE**  
COMMUNICATIONS

P.O. Box 1000  
Morgan Hill, CA 95037

## ADM-10'

When cost is a factor,  
don't sacrifice performance.



The ADM-10' satellite antenna system gives you the most for your investment. At the cost of an 8' dish, the ADM-10' provides performance margins to account for loss of signal due to satellite aging. Constructed of rugged steel or aluminum with fully adjustable polar mount. ADM-10'—the competitive edge in the private TVRO market.

For the competitive edge,  
call—

**ANTENNA  
DEVELOPMENT &  
MANUFACTURING, INC.**

P.O. BOX 1178 • POPLAR BLUFF, MO 63901 • (314) 785-5988

### Free Antenna Accessories Catalog



#### ◀ Coaxial Antenna Relay

Remotely select up to 9 ante from your transmitter, using only coaxial cable. Environmentalized, power and low loss.

#### W2AU and W2DU Baluns▶

Our baluns, center insulators and insulators have been preferred for 20 years by Hams, industry, and the armed forces. Protect against TVI and lightning 1.8-200 MHz.



#### ◀ W2VS Antenna Traps

Add these traps to your dipole get low SWR on 2 to 6 bands, depending on how many you add. Ant wire and custom kits also available

#### Send For Yours Today▶

Don't delay. Call or write today, and we will send you free literature which fully describes our Ham antenna accessory product line.

Dealer inquiries also welcome.



**UNADILLA/REYCO/INLINE**  
A Division of Microwave Filter Co., Inc.

6743 Kinne St., East Syracuse, NY 1  
Toll Free 1-800-448-1666 TWX 710-54  
NY/HI/AK/Canada (Collect) 315-437-





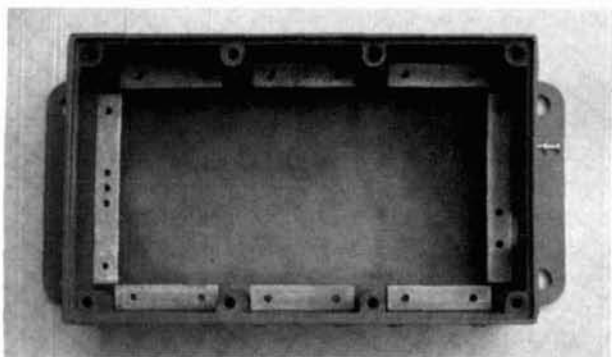

fig. 1. Interior view of box built for a wideband RF amplifier. (See *ham radio*, March 1984, pages 12-28.)

## build a better box

### How to modify pre-built enclosures for RF-tight design

Sometimes it seems that packaging a project is more difficult than building the actual project itself. In packaging a complete project, building the right box is critical, because if the packaging is not done well, the device inside may not work properly.

Commercially available die-cast boxes — you know, the ones that seem to be just about perfect for many things, but are never quite right for anything — appear, at first glance, to be ideal for small RF enclosures. There is no convenient way to mount *anything* in these. If you try to mount your neat, low noise, wideband amplifier in one of these boxes with a few standoffs to the bottom, you quickly find that your mounted amplifier has become an oscillator and now generates a considerable amount of output with no input.

If pre-manufactured boxes are to be used successfully for RF enclosures, particularly above several hundred megahertz, they must be modified first, with a solid, well defined grounding configuration to tightly couple the box to the circuit ground. The mechanical assembly described and illustrated in this article,

though not particularly simple, provides an excellent packaging configuration for small RF projects through L-band. Its fabrication should be well within the capability of most Amateurs (no machine shop is required) and result in a much more successful and professional-looking project than any collection of coffee cans, PC board pieces and shim stock, however skillfully assembled.

Fig. 1 shows what your finished project should look like using this method.

#### drilling patterns

I used a Pomona 2901 diecast box for this article, but similar products can be adapted with equal success. The overall assembly is shown in fig. 2. From that you can see the relative mounting positions of the eight mounting blocks and RF connectors. The details of the box modifications are shown in fig. 3. All holes must be positioned with reasonable accuracy. The best way to accomplish this manually is with a precision steel rule calibrated in tenths or hundredths of an inch. This should be available from almost any hardware store or machine tool supply store. Because the die-cast boxes vary somewhat in size, the holes in fig. 3 are dimensioned from the side center lines. Experience has shown that dimensioning from one end can lead to problems with fitting parts. Before drilling, be sure to centerpunch all holes to prevent the drill from "walking."

By Michael Gruchalla, 2450 Alamo Avenue, S.E., P.O. Box 9100, Albuquerque, New Mexico 87119

A number of different filters may be used. If you use other than the one listed, be sure to drill and tap the filter mounting hole to fit your particular filter.

Don't try to use solder-in filters; the box alloy is very difficult to solder. The various screw-mounted filters are your best choice. You'll also notice that one RF connector is centered and the other offset in the corresponding ends. This is a convenient layout, but be creative and mount the connectors where best suited to your project.

### treating the surface

The paint must be removed from the inside of the box where the mounting blocks are to be installed. The paint in these boxes is tenacious; the easiest method of removal is with a small sandblaster. But if you don't have a sandblaster in your work room the next best thing is sandpaper. A little work with about 120 grit wet-or-dry should do the trick. Use plenty of water to keep the paper from loading. (If you use regular sandpaper, don't use water — you'll end up with a handful of wet sand and soggy paper.)

An unpainted box such as the Pomona 2906 can also be used, but then you'll have to prepare the sur-

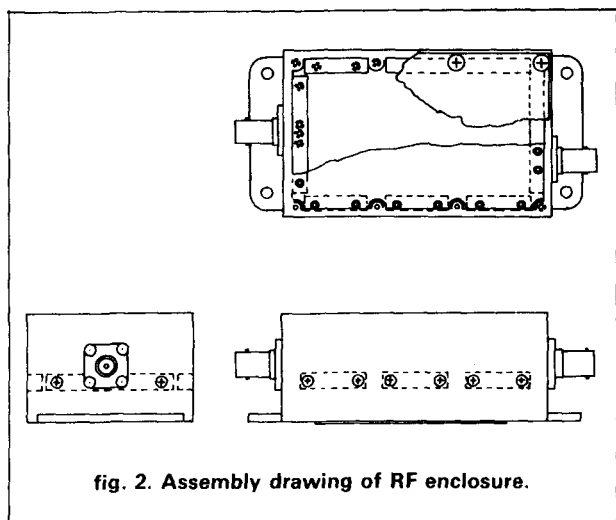

fig. 2. Assembly drawing of RF enclosure.

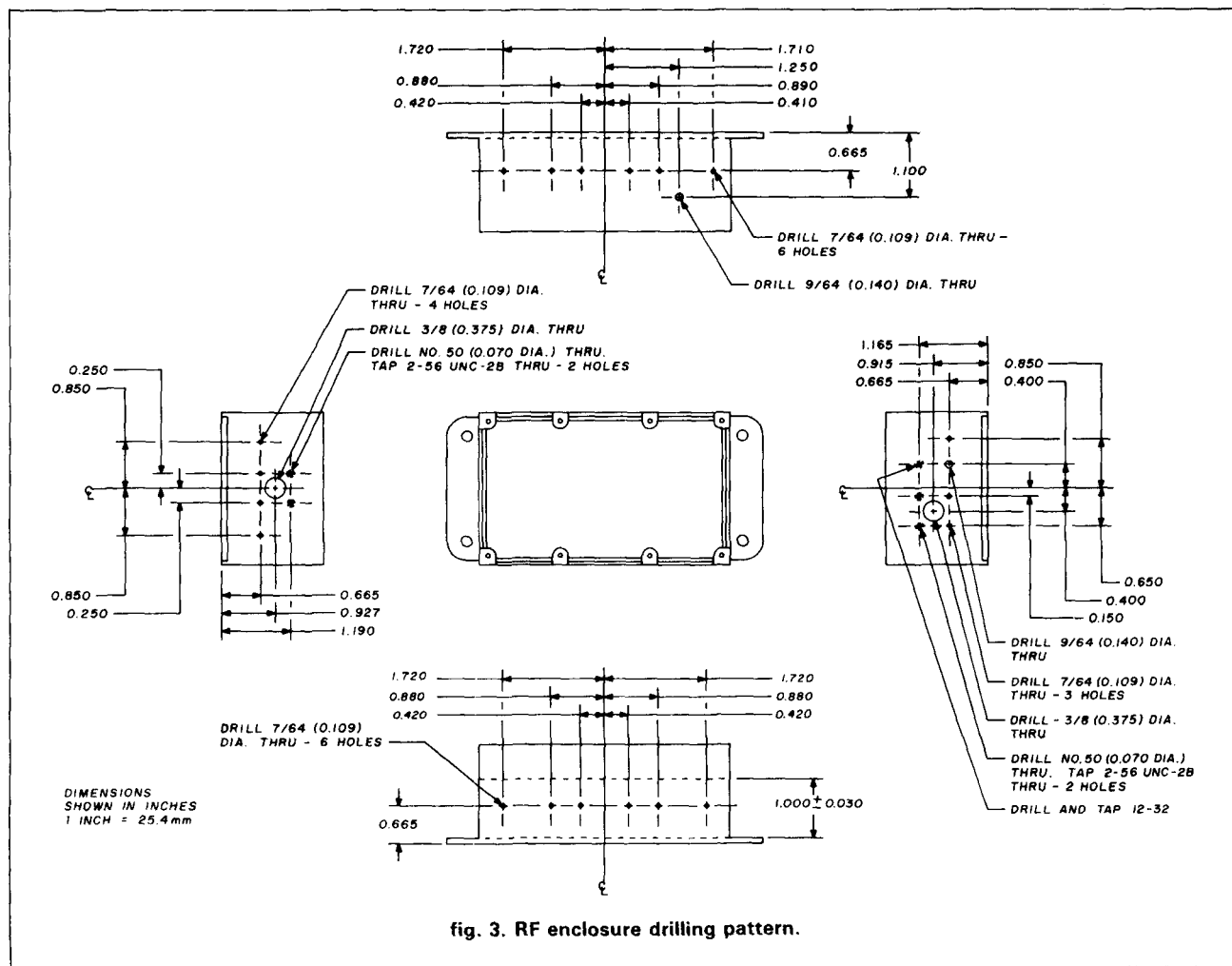
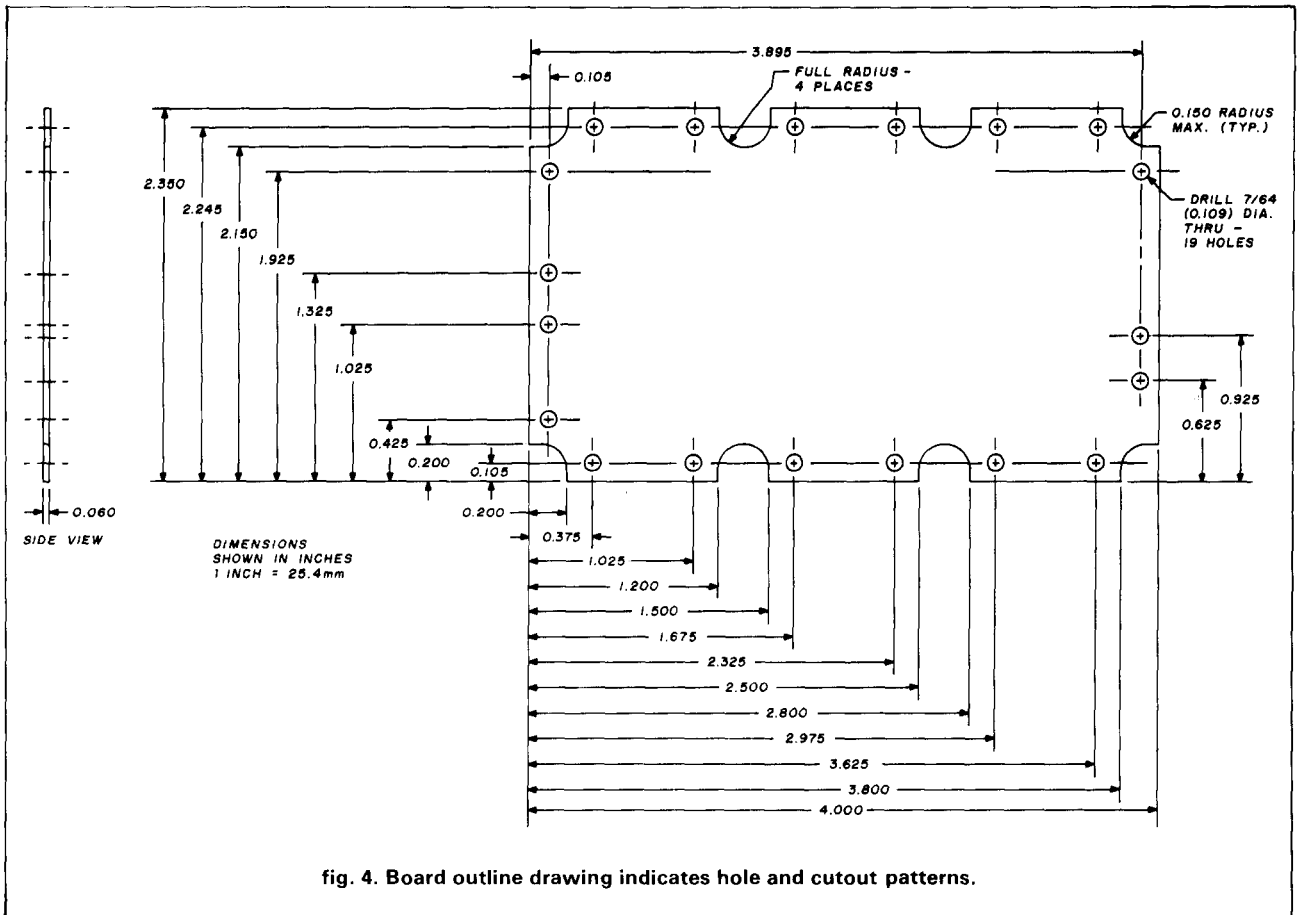

fig. 3. RF enclosure drilling pattern.





face and paint the finished unit for an attractive "professional" look. This can be tricky; the bare cast box requires considerable effort if you're determined to produce a visually appealing product. All things considered, I think the painted box — with interior paint removed — is the easier to use.

### interior details

Once you have all the holes drilled in the box and the paint is removed, you have to make all those little pieces that fit inside the box behind the holes. This is a tedious task, but with a little care and patience, good results can be expected. The details of the six side blocks and the two end blocks are shown in fig. 5. The 2-56 tapped holes are quite small, so you must be very careful when drilling and tapping — particularly in tapping. Use plenty of oil for both drilling and tapping, and be sure to back the tap out often to prevent jamming.

### component assembly

After all the interior pieces are completed, the box is ready for assembly. For a little more professional appearance, use flat washers with all the screws, but

be sure to mount the filter *without* a washer. On some filters, the thread is long enough to accept a nut on the inside of the box to lock the filter in place. You may have a problem purchasing the ground terminal specified in small quantities; if a suitable terminal cannot be found, a 3/4-inch, 4-40 screw and nut may be used. Place the nut about half way up the screw, drive the screw into the ground terminal location about 1/4 inch, and tighten the nut. Use a plated brass or steel screw to make soldering easier.

The finished box is now ready to have something put in it. What you install is up to you, but be sure your board is tailored to fit the box and mounting blocks. An outline drawing of the cutout and mounting details of the board is shown in fig. 4. This should help you in getting a board cut to fit the box. Be careful not to run any wiring or conductors within about 5/16 inch of the board edges, since that's where the mounting blocks attach.

This versatile packaging technique adapts easily to other boxes. When carefully done, it results in a professional-looking enclosure providing the strong electrical bond between the board ground plane and the box in critical RF circuits. I've used this assembly

ADVANCED  
CONSUMER  
ELECTRONICS

# WE CAN PUT THE WORLD AT YOUR FINGERTIPS WITH... KENWOOD, ICOM, AND YAESU TRANSCEIVERS.

Over the past 58 years Harvey Electronics has offered its customers the finest products in the HAM category. And for 1984, Harvey Electronics has picked the most innovative HF Transceivers to provide the best possible communications in the amateur field.



## KENWOOD TS-930S HF TRANSCEIVER

The TS-930S is a solid state HF Transceiver keyed to the exacting requirements of the DX and contest operator. It covers all Amateur bands from 160 through 10 meters, and incorporates a 150kHz to 30MHz general coverage receiver having an excellent dynamic range; it also features SSB slope tuning, CW/VBT, IF notch filter, CW pitch control, dual digital VFO's, full break-in on CW and an automatic antenna tuner.



## ICOM IC-751 HF TRANSCEIVER

The IC-751 is ICOM's most advanced amateur transceiver. It is a 100kHz to 30MHz continuous tuning general coverage receiver, and a full featured all mode solid state ham band transmitter, that covers all the new WARC bands. And with an optional internal AC power supply it becomes a compact portable. It also features dual VFOs, 32 tunable memories, SSB filter, FM squelch and more.



## YAESU FT-980 COMPUTER AIDED HF TRANSCEIVER

The FT-980 CATX presents a new leap forward in the amateur field, incorporating an 8-bit microprocessor (80C85) for the highest level of built-in computer control ever offered in an all mode, all solid state HF transceiver. Plus, it features continuous general coverage reception from 150kHz to 30MHz, a 12 channel memory system, Dual VFOs and programmable bands for tuning limits.

# HARVEY ELECTRONICS

Pro Division  
25 West 45th Street, New York, NY 10036  
(212) 921-5920 (800) 223-2642

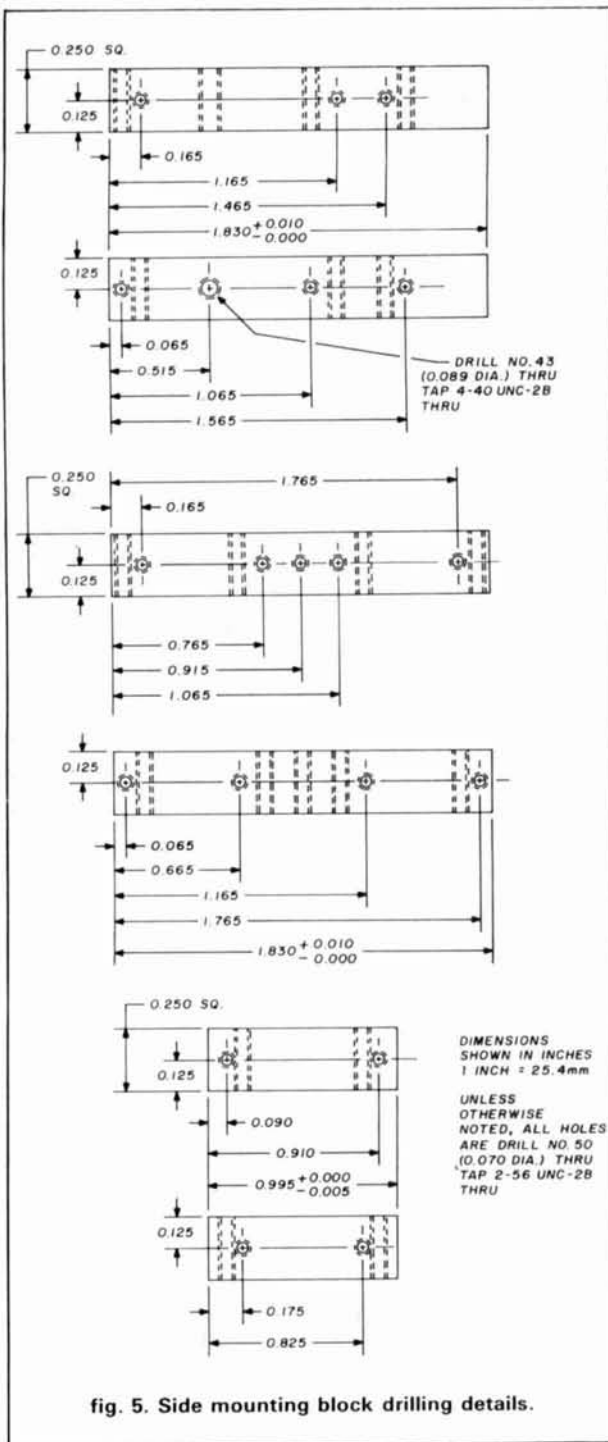

fig. 5. Side mounting block drilling details.

with excellent results for applications in excess of 1500 MHz; good luck on your future projects.

ham radio

## SHORT CIRCUIT HOTLINE

Building a current ham radio project? Call the Short Circuit Hotline any time between 9 AM and Noon, or 1 to 3 PM — Eastern time — before you begin construction. We'll let you know of any changes or corrections that should be made to the article describing your project.

(See "Publisher's Log," April, 1984, page 6, for details.)

603-878-1441

# B. G. MICRO

P. O. Box 280298 Dallas, Texas 75228

(214) 271-5546

✓ 117



## 74LS

LS00	.24	LS164	.60
LS01	.24	LS165	.90
LS02	.24	LS166	.99
LS03	.24	LS169	1.25
LS04	.24	LS174	.60
LS05	.24	LS175	.50
LS08	.24	LS181	1.99
LS10	.24	LS191	.90
LS11	.24	LS192	.80
LS12	.30	LS193	.80
LS13	.50	LS195	.65
LS14	.50	LS197	.85
LS20	.24	LS221	.80
LS21	.25	LS240	.95
LS27	.24	LS241	.80
LS30	.28	LS242	.90
LS32	.36	LS243	.90
LS42	.49	LS244	1.25
LS51	.24	LS245	1.50
LS74	.40	LS251	.50
LS85	.60	LS257	.55
LS86	.39	LS258	.55
LS90	.50	LS266	.50
LS93	.55	LS273	1.25
LS109	.39	LS279	.45
LS112	.39	LS283	.60
LS123	.75	LS290	.85
LS124	2.75	LS293	.85
LS125	.45	LS298	.89
LS132	.50	LS299	1.60
LS133	.49	LS366	.45
LS138	.60	LS367	.50
LS139	.60	LS368	.40
LS151	.50	LS373	1.25
LS153	.50	LS374	1.35
LS154	1.75	LS375	1.19
LS155	.50	LS377	1.49
LS156	.55	LS378	.85
LS157	.60	LS390	1.19
LS161	.60	LS393	1.19
LS162	.65	LS399	1.25
LS163	.50		

## TTL

7400	.19	74125	.49
7402	.19	74151	.50
7404	.19	74154	1.19
7408	.24	74157	.50
7410	.19	74164	.75
7440	.19	74174	.85
7474	.35	74175	.79
7486	.29	74367	.59
74109	.45		

## 6500

6502	4.50	6545	10.00
6522	6.95	6551	10.00

## 6800

6800	2.50	6840	10.00
6802	5.00	6845P	10.00
6803	14.95	6850	2.60
6810	2.00	68A21	4.95
6820	3.25	68B45	17.50
6821	2.95		

## EPROM

2708 1KX8 450 n.s.	2.20
27A08 1KX8 350 n.s.	3.95
2758 1KX8 +5V 450 n.s.	2.50

<b>2716 2KX8</b>	
450 n.s.	3.20

2716-1 2KX8 350 n.s.	5.50
2732 4KX8 450 n.s.	4.75
2532 4KX8 450 n.s.	5.50
2764-25 250 n.s.	7.50

## EPROM SPECIAL

We bought a large quantity of 2708s from a computer manufacturer who redesigned their boards. We removed them from sockets, erased and verified them, and now we offer the savings to you. Complete satisfaction guaranteed.

2708  
\$1.49 or 10/\$12.00

## STATIC RAM

<b>TMM2016-2KX8</b>	
200 n.s.	8/39.95
<b>2101-1 - 256X4</b>	
500 n.s.	.75
<b>21L02-1 350 n.s.</b>	
	.65
<b>2102AL-4 L.P. 450 n.s.</b>	
	.49
<b>2114L-3 1KX4 300 n.s.</b>	
L. P.	2.75 8/16.00
<b>TMS4044 (MCM6641 C-25)</b>	
4KX1 250 n.s.	8/6.00
<b>TMS4046 450 n.s.</b>	
	.65
<b>5101E-8 - 256X4 - CMOS</b>	
	\$1.00
<b>HM6116P-4-2KX8</b>	
200 n.s. CMOS	8/39.95
<b>6501-5 256X4 - CMOS - Data Retention 2 Volts - 22 Pin - 200 n.s. Typ. - 5V - Very Low Power</b>	
	1.00
<b>8108-5 1KX8 NMOS 500 NS</b>	
22 Pin	2.00

## 4K STATIC RAMS

LESS THAN 50¢ EACH  
MK4104J-4 - 250 N.S. 18 Pin  
Ceramic Computer Mfg.  
Surplus. PRIME. Fully Static.  
Easy to Use. Has Same Pin Out  
as TMS4044, but slightly  
different timing. With Specs.  
(Mostek)

8 for 5.00 32 for 15.95  
VERY LOW POWER!

## DMA CONTROLLER

<b>SPECIAL</b>	
9517A-4 (8237-4)	10.50

## DYNAMIC RAM

<b>5280N-5 (2107B-4 • TMS4060)</b>			
4KX1			8/3.95
4027-4KX1-250 n.s.			1.00
4116-16KX1-250 n.s.			8/9.00
4116-16KX1-200 n.s.			8/11.50
4164- +5v 64K 200 n.s.			8/48.00

## 8000

Z8002	29.95	8085A	5.95
8035	4.50	8086-2	30.00
8039	5.00	8087-3	175.00
8080A	2.00	8088	20.00

## 8200

8202A	15.95	8253	4.95
8212	1.25	8253-5	5.95
8214	2.00	8255-5	5.50
8216	1.50	8257	6.00
8224	1.50	8259A	4.95
8228	3.00	8275	19.95
8237-4	10.50	8279-5	7.95
8250B	9.95	8287	5.75
8251	3.95	8288	24.95

## DIP SWITCH

<b>DT08 BY ALCO</b>	
<b>8 POSITION DIP SWITCH</b>	
Super low profile -	
Made for automatic insertion -	
<b>SPECIAL — .90</b>	<b>10/7.50</b>
DT-10	1.00 10/8.50

## Z80

Z80 2.5 MHZ CPU	3.50
Z80CTC	3.75
Z80DMA-DMA	9.95
Z80PIO	3.95
Z80SIO/O	16.95
Z80A-4MHZ CPU	4.95
Z80A DART	9.95
Z80A-PIO	5.95
Z80A SIO/O	19.95
Z80B 6 MHZ CPU	14.95

## UART

1602 (COM 2017)	2.95
1863	3.95
IM6402-+5v High speed	
UART-AY5-1013 pin out	2.95
INS 8250B	9.95

## 2114 SPECIAL!

COMPUTER  
MANUFACTURERS  
EXCESS INVENTORY  
SALE!

PRIME! 2114-300 n.s.  
INCREDIBLE PRICE!  
YOU SAVE!

8/\$9.00  
GUARANTEED

## SOCKETS

### Low Profile SOLDER TAIL

6 Pin	14/1.00
8 Pin	13/1.00
14 Pin	10/1.00
16 Pin	8/1.00
18 Pin	8/1.00
20 Pin	7/1.00
24 Pin	6/1.00
28 Pin	6/1.00
40 Pin	5/1.00

BUY \$10

GET \$1.00

FREE CHOICE

## F.D. CONTROLLERS

1771 Single Density	15.00
1791 Double Density	20.00
1793	22.00
1797	24.95
2793	35.95

## CONTROLLER SET

THREE CHIP SET  
1797, 2143-03, 1691 by W.D.  
Compare at up to 86.85.  
B.G. SPECIAL  
All 3 for only \$29.95

## CRYSTALS

32.768 Khz SPECIAL	.65
262.144	.75
300.000	1.00
307.200	1.25
1.5432 Mhz	.75
1.8432	2.49
2.000000	2.49
3.000	1.15
3.120	1.20
3.579545 - HC18	1.00
4.000	2.49
4.194304	1.50
4.433618	.75
4444.000	1.25
4.9152	2.49
4.916 Bd. Rate	1.25
5.000000	1.50
5.0688	3.75
5.616	1.59
8.000	1.99
9.90000	1.25
10.69425	3.75
10.8864	1.49
11.088	1.59
13.440	1.00
12.000	2.75
15.2	1.10
14.31818	2.49
16.00000	1.50
17.430	2.49
18.2259	1.00
20.000	3.75
21.87108	1.00
22.092	1.00
32.000	2.49
40.000	2.00
87.3333	1.00
91.000	1.00
104.8	1.00

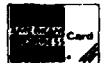

**Big Computer Mfg. Makes \$900,000 Goof!!**

## COMPUTER/DISK DRIVE SWITCHING POWER SUPPLY

ORIGINALLY DESIGNED TO RUN A Z-80  
BASED SINGLE BOARD COMPUTER  
WITH TWO 5-1/4 IN. DISK DRIVES AND  
CRT MONITOR.

ORIGINAL  
OEM COST  
\$72 EACH!

**\$37<sup>50</sup>** EA

**3 FOR \$95<sup>00</sup>**

**BRAND NEW: UNUSED!**

ADD \$1.50 PER UNIT FOR UPS

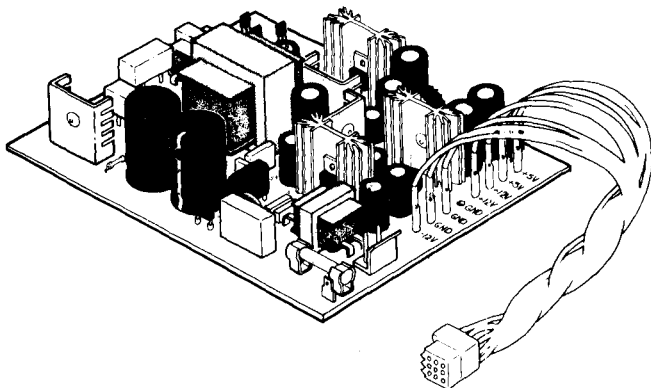

SPECS: + 5VDC 5 AMPS MAX  
#1 + 12 VDC 2.8 AMPS MAX  
#2 + 12 VDC 2.0 AMPS MAX  
- 12 VDC .5 AMPS MAX

INPUT: 115 or 230 VAC 60Hz

SMALL SIZE: 6-1/8 x 7-3/8 In.  
HIGH EFFICIENCY SWITCHER MFG.  
BY CAL. DC IN USA!

The poor Purchasing Agent bought about 10 times as many of these DC switchers as his company would ever use! We were told that even in 10,000 piece lots they paid over \$72 each for these multi-output switchers. When this large computer manufacturer discontinued their Z-80 Computer, guess what the Big Boss found in the back warehouse; several truckloads of unused \$72.00 power supplies. Fortunately we heard about the deal and made the surplus buy of the decade. Even though we bought a huge quantity, please order early to avoid disappointment. Please do not confuse these high quality American made power supplies with the cheap import units sold by others.

✓ 118

TERMS: Orders over \$50 add 85¢ insurance. No COD. Tex. Res. Add 6% Sales Tax. Subject to prior sale. Foreign orders: US funds only. We cannot ship to Mexico. Foreign countries other than Canada add \$6 per board shipping.





## Z80\* SINGLE BOARD COMPUTER!

64K RAM — 80 x 24 VIDEO DISPLAY — FLOPPY DISK CONTROLLER  
RUNS CP/M\* 2.2!

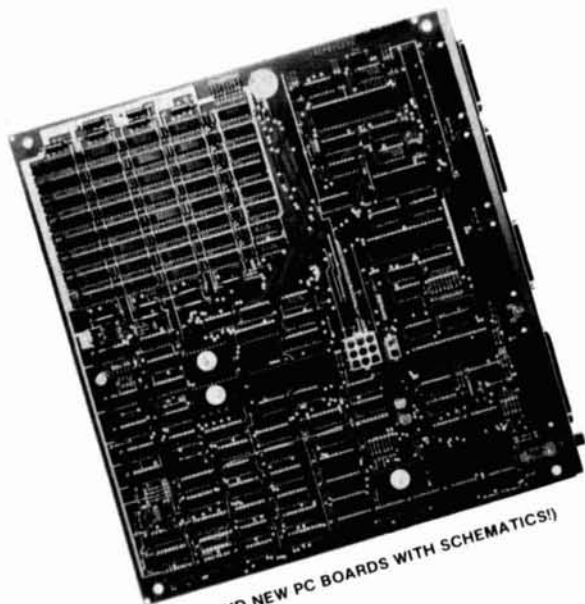

(BRAND NEW PC BOARDS WITH SCHEMATICS!)

**\$29.95**

(BLANK BOARD WITH  
DATA AND ROM'S.)

**NEW PRICE**

**GROUP SPECIAL:  
BUY 6 FOR \$165!**

**USES EASY  
TO GET PARTS!**

**BOARD MEASURES  
11 1/2" x 12 1/2"**

**ALL ORDERS WILL BE  
PROCESSED ON A STRICT,  
FIRST COME, FIRST SERVED  
BASIS! ORDER EARLY!**

### GIANT COMPUTER MANUFACTURER'S SURPLUS!

### UNBELIEVABLE LOW PRICE!!!

Recently Xerox Corp. changed designs on their popular 820\* computer. These prime, new, 820-1 PC boards were declared as surplus and sold. Their loss is your gain! These boards are 4 layers for lower noise, are solder masked, and have a silk screened component legend. They are absolutely some of the best quality PC boards we have seen, and all have passed final vendor QC. Please note, however, these surplus boards were sold by Xerox to us on an AS IS basis and they will not warranty nor support this part.

We provide complete schematics, ROM'S, and parts lists. If you are an *EXPERIENCED* computer hacker, this board is for you! Remember, these are prime, unused PC boards! But since we have no control over the quality of parts used to populate the blank board, we must sell these boards as is, without warranty. You will have to do any debugging, if necessary, yourself!

ADD \$2 PER PC BOARD FOR SHIPPING. (USA and Canada)

\*CP/M TM OF DIGITAL RESEARCH INC. (CALIF.) 820 TM OF XEROX CORP. Z80 TM OF ZILOG

### WE'VE GOT EM!

5-1/4"

### HALF SIZE DRIVES

- 40 Track per side
- Double-sided, double density
- Same as SA455
- Latest head & drive technology
- Fast access time

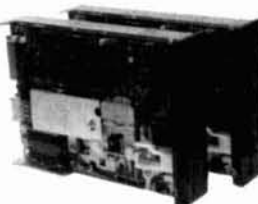

Two of These Half Size Drives will  
Fit in the Same Space as 1 Full Size Drive!

**\$179.00 per drive**

Compare at up to \$349 ea.

ADD \$3.00 UPS PER DRIVE

TERMS: Orders over \$50 add 85¢ insurance. No COD. Tex. Res. Add 6% Sales Tax. Subject to prior sale. Foreign orders: US funds only. We cannot ship to Mexico. Foreign countries other than Canada add \$6 per board shipping.

# cooling semiconductors

## part 2: blowers and fans

Heatsinks aren't  
the only way  
to dissipate  
excess heat

This article has been adapted, with permission, from *IC Voltage Regulator Sourcebook with Experiments*, by Vaughn D. Martin, published by TAB Books, Inc., and available from Ham Radio's Bookstore, Greenville, New Hampshire 03048 (\$14 postpaid).

In Part One of this series we discussed the design and use of heatsinks in cooling electronic equipment. In this part, we'll examine the several other means by which excess heat can be prevented, monitored, and dissipated.

While heat sinks are without doubt the most familiar means of moving heat away from electronic equipment, they can be of limited use if the ambient temperature itself is high, or if the area surrounding the unit remains warm because heat is not evacuated quickly enough. If, for example, a power supply were enclosed in a poorly ventilated cabinet, a heat sink would be of little or no use; in such a situation, a fan or blower would be more effective.

While similar to heat sinks in principle, fans and blowers are significantly different in application and design. Fans (see fig. 1) generally employ propeller-like blades to move large volumes of low-pressure air. Blowers, on the other hand, usually consist of a revolving wheel that displaces air; they are therefore more efficient while operating near their maximum (non-moving) pressure (see fig. 2).

In cooling a poorly ventilated cabinet, pressurization of the enclosure by pumping filtered air *in* is vastly preferable to drawing air *out* because air pulled into

the cabinet may contain particulate matter whose presence, over time, can compound the problem of temperature control by collecting in cabinet openings, such as those between panels or around doors, and blocking the exit of air.

Of the four methods of cooling electronic equipment housed in cabinets — forced-convection filtered air, air-to-air heat exchangers, air-to-water heat exchangers, and specially packaged air conditioning units — only the first (see fig. 3) is appropriate for Amateur Radio applications.

### forced-air cooling

In designing the forced-convection filtered air-cooling of the interior of an equipment cabinet, five design guidelines should be followed: first, there should be no constrictions; the cross-sectional area of the air current should be at least as large as the intake. Second, the exhaust area must be located *downstream* from the heat-producing elements. Third, baffles work best when used to channel a small volume of air across an exceedingly hot component at a high velocity. Fourth, ducts may be used to maintain a more even cooling effect throughout the cabinet. If maintenance of an even temperature from the top to bottom of the cabinet is important, ducts should be located along the sides of the cabinet.

Finally, because blowers and especially fans can cause vibration, it's important that neoprene vibration isolators or similar devices be built into the fan if this is a concern. If you decide to use a fan, using the following two formulas will enable you to determine the required fan size:

$$\begin{aligned} \text{volume of air} &= \frac{3.17 \times \text{power} \times 1.25}{T (^{\circ}\text{F})} \\ \text{at inlet} &= \frac{1.76 \times \text{power} \times 1.25}{T (^{\circ}\text{C})} \end{aligned}$$

By Vaughn D. Martin, 114 Lost Meadows, Cibolo, Texas 78108

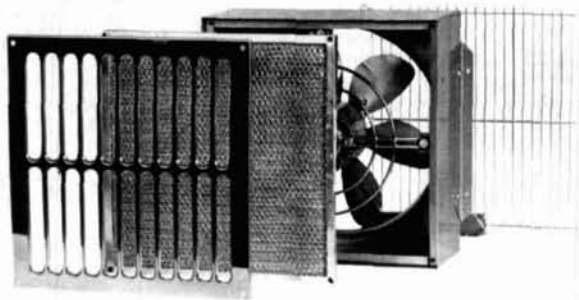

fig. 1. A typical fan used for ventilation purposes. (Photo courtesy McLean Engineering, Inc.)

The power to be dissipated is expressed in watts; the temperature is the average temperature rise within the cabinet, expressed in the first equation as degrees Fahrenheit and in the second equation as degrees Celsius. These two formulas as well as the nomograph shown in **fig. 4** have a built-in safety factor of 25 percent (note the 1.25 for 125 percent). If only a quick approximation is required, the nomograph may be used.

Let's work through a typical design example, assuming we are designing for a typical cabinet and using both the formula and the nomograph. Let's strike a line through the nomograph and see how close it comes to the exact calculated value.

Assume we have exactly 200 watts of power to be dissipated and can accept only a 10°F rise in temperature within the cabinet. The first equation for degrees Fahrenheit yields  $[(3.17)(200 \text{ watts})(1.25)]/10 = 79.25 \text{ cubic feet per minute}$ . Note in **fig. 4** that the nomograph indicates approximately 80 cubic feet per minute — very close to 79.25, the value derived by actual calculation.

## thermoelectric devices

In addition to forced air venting, thermoelectric devices such as Peltier and Thomson-Joule devices may be used to pull heat away from a specific small area in the cabinet or a critical semiconductor that must remain cool.

Four basic physical phenomena are associated with thermoelectric devices:

- The *Seebeck effect* is the EMF that exists when two dissimilar conductors are connected and have their junctions maintained at different temperatures. This is the basis of thermocouples.
- The *Thomson effect* is the heating or cooling effect that takes place in a homogeneous conductor when an electric current passes in the direction of the temperature gradient.
- The *Joule effect* occurs when an electric current

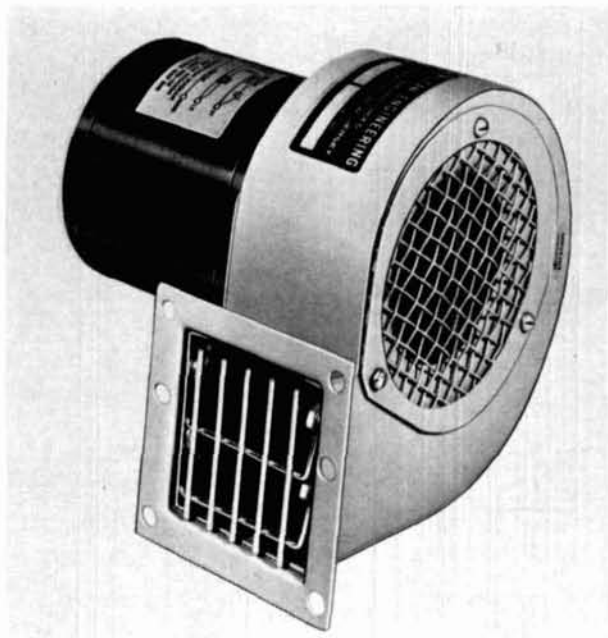

fig. 2. A typical blower along with a housing for blowers. (Photo courtesy McLean Engineering, Inc.)

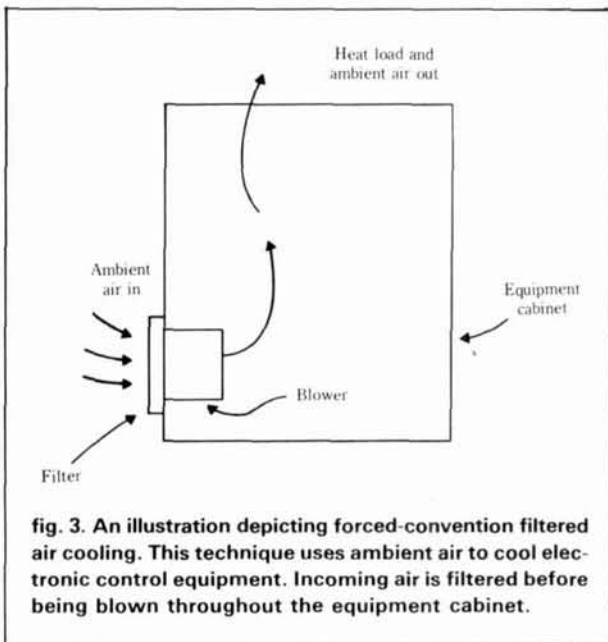

fig. 3. An illustration depicting forced-convection filtered air cooling. This technique uses ambient air to cool electronic control equipment. Incoming air is filtered before being blown throughout the equipment cabinet.

passes through a conductor (which is isothermal or maintains the same temperature throughout) and generates heat — this is called "Joule heat."

- The *Peltier effect*, named in honor of Jean C.A. Peltier, who in 1834 discovered that the passing of electric current through the junction of two dissimilar materials causes a cooling effect when passed in one direction and a heating effect when the direction of current flow is reversed.

The Seebeck, Peltier, and Thomson effects are all

# WE HAVE QUALITY PARTS, DISCOUNT PRICES AND FAST SHIPPING!

### TRANSFORMERS



120 volt primaries

5.6 VOLTS @ 750 MA	\$3.00
6 VOLTS @ 150 MA	\$1.25
12 VCT @ 200 MA	\$2.00
16.5 V @ 3 AMPS	\$6.50
18 V @ 650 MA	\$3.50
18 VOLTS @ 1 AMP	\$4.50
24 VOLTS @ 250 MA	\$2.50
24 VCT @ 1 AMP	\$4.50
42 VCT @ 1.2 AMP	\$4.50

### HELPING HAND

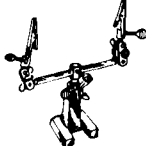

WILL HOLD P.C. BOARD OR OTHER SMALL ITEMS AND ALLOW BOTH YOUR HANDS FREEDOM TO WORK

**\$6.50 EACH**

### MIKE CONNECTOR



5 CONDUCTOR IN-LINE PLUG AND CHASSIS MOUNT JACK TWIST LOCK STYLE. SAME AS SWITCHCRAFT 12CL5M.

**\$2.50 PER SET**

### LIGHTS

#### GRAIN OF WHEAT

T1 SIZE 

125" DIA. (3.15mm)

3 to 6 VOLTS 3 for \$1.00  
Rated 55ma @ 5 VOLTS

6 to 12 VOLTS 3 for \$1.00  
Rated 55ma @ 8 VOLTS

12 to 24 VOLTS 3 for \$1.00  
Rated 45ma @ 14 VOLTS

### 8 TRACK RECORD/PLAY TAPE DECK



MORSE MODEL 94-A

### WALL TRANSFORMER

ALL ARE 115 VAC PLUG IN 

4 VDC @ 70 MA	\$2.00
6 VDC @ 100 MA	\$2.50
6 VDC @ 500 MA	\$5.00
9 VDC @ 725 MA	\$3.00
14 VDC @ 300 MA	\$3.50
15 VAC @ 300 MA	\$3.00
16.5 VAC @ 10 VA	\$3.50
17 VAC @ 500 MA	\$4.00

### MULTI-SWITCHES

#### 3 STATION NON-INTERLOCKING

3 - 2PDT SWITCHES EACH OPERATES INDEPENDENTLY

1 3/4" BETWEEN MOUNTING CENTERS

**\$1.75 EACH**

### METER

0 - 15 V.D.C.

THIS 2-1/4" SQUARE METER MEASURES 0-15 VDC.

**\$4.50 EACH**

### T1 SIZE WITH WIRE LEADS

3 to 6 VOLTS 2 for \$1.00  
Rated 55ma @ 5 VOLTS

6 to 12 VOLTS 2 for \$1.00  
Rated 55ma @ 8 VOLTS

12 to 24 VOLTS 2 for \$1.00  
Rated 45ma @ 14 VOLTS

8 TRACK RECORD WITH AUTO STOP. NOT FULLY FUNCTIONAL. REMOVED FROM ASSEMBLY LINE FOR MINOR PROBLEMS. IDEAL FOR PARTS. EACH UNIT CONTAINS SWITCHES, LIGHTS, TAPE MOTOR, BELT, WHEELS, PULLEYS, PRE AMPS, TAPE HEADS, ETC

**\*SPECIAL PRICE\* \$4.00 EACH**  
10 for \$35.00

### SPRING LEVER TERMINALS

TWO COLOR CODED TERMINALS ON A STURDY 2 3/4" x 3 3/4" BAKELITE PLATE

GREAT FOR SPEAKER ENCLOSURES OR POWER SUPPLIES

**\$1.00 EACH** 10 FOR \$9.00

### 5 STATION INTERLOCKING

MADE BY ALPS

3 - 2PDT AND 2 - 6PDT SWITCHES ON FULLY INTERLOCKING ASSEMBLY

3 1/4" BETWEEN MOUNTING CENTERS

**\$2.50 EACH**

### SUB-MINIATURE D TYPE CONNECTOR



SOLDER TYPE SUB-MINIATURE CONNECTORS USED FOR COMPUTER HOOK UPS

DB-15 PLUG	\$2.75
DB-15 SOCKET	\$4.00
DB-15 HOOD	\$1.50
DB-25 PLUG	\$2.75
DB-25 SOCKET	\$3.50
DB-25 HOOD	\$1.25

### T1 - 3/4 SIZE WITH WIRE LEADS

.163" DIA. (4.14mm)

3 to 6 VOLTS 2 for \$1.00  
Rated 45ma @ 6 VOLTS

6 to 12 VOLTS 2 for \$1.00  
Rated 55ma @ 8 VOLTS

12 to 24 VOLTS 2 for \$1.00  
Rated 45ma @ 14 VOLTS

### 2K 10 TURN MULTI-TURN POT

SPECTROL #MOD 534-7161

**\$5.00 EACH**

### SWITCHES

#### MINI-PUSH BUTTON

S.P.S.T. MOMENTARY NORMALLY OPEN 1/4" BUSHING

**35¢ EACH**  
10 FOR \$3.25  
100 FOR \$30.00

SPECIFY COLOR: RED, BLACK, WHITE, GREEN, YELLOW

### 2 CHANNEL LIGHT ORGAN

EASILY HOOKS INTO STEREO SPEAKERS AND ALLOWS 110 VAC LIGHTS TO DANCE WITH MUSIC. TWO SEPARATE 110 VAC OUTPUTS FOR HIGH AND LOW FREQUENCY AUDIO SIGNALS. USE TWO ORGANS FOR STEREO

**\$6.50 PER UNIT**

COLOR LIGHT STRING AVAILABLE \$1.75 EA

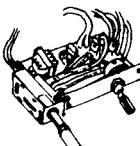

### "PARALLEL" PRINTER CONNECTOR



SOLDER STYLE 36 PIN MALE USED ON "PARALLEL" DATA CABLES

**\$5.50 EACH**

### NEON W/ RESISTOR

DIRECT OPERATION

7 for \$1.00 FROM 120 VOLT

### EDGE CONNECTORS

ALL ARE .156" SPACING

**18/36 GOLD SOLDER EYELET \$2.00 EACH**

### KEY SWITCH

S.P.S.T. 4 AMPS @ 125 VAC

KEY REMOVES BOTH POSITIONS

**\$3.50 EA**



### 120V INDICATOR

NEON INDICATOR RATED 120 V 1/3 W. MOUNTS IN 5/16" HOLE. RED LENS

**75¢ EACH**  
10 FOR \$7.00  
100 FOR \$65.00

**22/44 TIN P.C. STYLE, NO MOUNTING EARS \$1.50 EACH** 10 FOR \$14.00

### LIGHTED PUSH BUTTON

RED LIGHTED 120 VAC 10 AMP. S.P.S.T.

"POWER" PRINTED ON FACE MOUNTS IN 7/8" SQUARE HOLE

**\$1.50 EA** 10 FOR \$13.50



FREE! FREE! FREE! SEND FOR **NEW LARGER!** 48 PAGE CATALOG FREE! FREE! FREE!

### LINE CORDS

TWO WIRE 6 18ga TWO WIRE 3 FOR \$1.00

THREE WIRE 18 INCH 18ga THREE WIRE 2 for \$1.00

8 FOOT 18ga THREE WIRE \$2.00 EACH

### KEY ASSEMBLY

5 KEY  \$1.00 EACH

CONTAINS 5 SINGLE-POLE NORMALLY OPEN SWITCHES MEASURES 3 3/4" LONG

6 KEY  \$1.25 EACH

CONTAINS 6 SINGLE-POLE NORMALLY OPEN SWITCHES MEASURES 4 1/4" LONG

### ROTARY SWITCH

1 POLE 6 POSITION 

1 1/4" DIA x 1 1/2" HIGH

**75¢ EACH** 10 for \$6.00

### COMPUTER GRADE CAPACITORS

2,000 mfd. 200 VDC	\$2.00
1 3/4" DIA. - 5" HIGH	
3,600 mfd. 40 VDC	\$1.00
1 3/8" DIA. - 3 3/4" HIGH	
6,400 mfd. 60 VDC	\$2.50
1 3/8" DIA. - 4 1/4" HIGH	
21,000 mfd. 50 VDC	\$4.00
2 1/2" DIA. - 5" HIGH	
22,000 mfd. 40 VDC	\$3.00
2" DIA. - 6" HIGH	
31,000 mfd. 15 VDC	\$2.50
1 3/4" DIA. - 4" HIGH	
44,000 mfd. 35 VDC	\$4.00
2" DIA. - 5" HIGH	
72,000 mfd. 15 VDC	\$3.50
2" DIA. - 4 3/8" HIGH	
185,000 mfd. 6 VDC	\$1.50
2 1/2" DIA. - 4 1/2" HIGH	

CLAMP TO FIT CAPACITORS 50¢ ea

### SLIDE POTS

100K linear tape 2" LONG

1 5/8" TRAVEL 75¢ EACH

500K linear taper 2 7/8" LONG

1 3/4" TRAVEL 75¢ EACH

DUAL 100K audio taper 3 1/2" LONG

2 1/2" TRAVEL \$1.50 EACH

### L.E.D.'S STANDARD JUMBO DIFFUSED

RED 10 FOR \$1.50

GREEN 10 FOR \$2.00

YELLOW 10 FOR \$2.00

FLASHER LED 5 VOLT OPERATION RED JUMBO SIZE \$1.00 EACH

BI POLAR LED 2 FOR \$1.70

SUB MINI LED 079" x 098" RED 10 FOR \$1.00 200 FOR \$18.00 GREEN 10 FOR \$1.50

LED HOLDERS TWO PIECE HOLDER FOR JUMBO LED 10 FOR 65¢ 200 FOR \$10.00

### SOLDERING IRON STAND

SPRING STEEL IRON HOLDER ON WEIGHTED BASE 

**\$5.00 EACH**

### BATTERY OPERATED SMOKE DETECTOR

BRK MODEL #79R UL APPROVED 9 VOLT BATTERY OPERATION FOR CEILING OR WALL MOUNT

**\$8.00 EACH** 2 FOR \$15.00

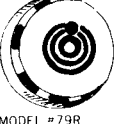

### RELAYS

#### MINIATURE 6 VDC RELAY

SUPER SMALL SPDT RELAY. GOLD COBALT CONTACTS

RATED 1 AMP AT 30 VDC HIGHLY SENSITIVE. TTL DIRECT DRIVE POSSIBLE. OPERATES FROM 4.3 TO 6 V. COIL RES 220 OHM

1 3/16" x 1 3/32" x 7/16" AROMAT # RSD-6V

**\$1.50 EACH** 10 FOR \$13.50

### CRYSTALS

CASE STYLE HC33/U

2 MHZ COLORBURST 3579.545 KC

**\$3.50 EACH** \$1.00 EACH

### METAL OXIDE VARISTOR

GE # VB2A12 50 VOLTS NOMINAL D.C VOLTAGE. 5/8" DIAMETER

**2 FOR \$1.50**

### TRANSISTORS

2N706	5 for \$1.00
2N2222A	4 for \$1.00
PN2222	8 for \$1.00
2N2904	4 for \$1.00
2N2905	4 for \$1.00
2N2907	4 for \$1.00

### 13 VDC RELAY

CONTACT S.P.N.C 10 AMP @ 120 VAC

ENERGIZE COIL TO OPEN CONTACT

COIL 13 VDC 650 OHMS

SPECIAL PRICE **\$1.00 EACH**

### 4 PDT RELAY

14 pin style

3 amp contacts

24 volt d.c. or 120 volt a.c. coil

Used but fully tested

**\$1.70 EACH**

specify coil voltage

LARGE QUANTITIES AVAILABLE

SOCKETS FOR RELAY 50¢ each



### MINIATURE TOGGLE SWITCHES

ALL ARE RATED 5 AMPS @ 125 VAC

S.P.D.T. (on-on) P.C. STYLE NON-THREADED BUSHING 75¢ EACH 10 FOR \$9.00 100 FOR \$80.00	S.P.D.T. (on-on) SOLDER LUG TERMINALS \$1.00 EACH 10 FOR \$9.00 100 FOR \$80.00	S.P.D.T. (on-off-on) SOLDER LUG TERMINALS \$1.00 EACH 10 FOR \$9.00 100 FOR \$80.00
S.P.D.T. (on-off-on) NON-THREADED BUSHING P.C. STYLE 75¢ EACH 10 FOR \$7.00 100 FOR \$70.00	S.P.D.T. (on-on) P.C. LUGS THREADED BUSHING \$1.00 EACH 10 FOR \$9.00 100 FOR \$80.00	D.P.D.T. (on-on) SOLDER LUG TERMINALS \$2.00 EACH 10 FOR \$19.00 100 FOR \$180.00

### PHOTO-FLASH CAPACITORS

35 MFD 330 VOLT 1" x 5/8" DIA 45¢ EACH... 10 FOR \$4.00

170 MFD 330 VOLT 1 1/8" x 7/8" 2 FOR \$1.50 10 FOR \$7.00

750 MFD 330 VOLT 2" HIGH x 1 1/4" DIA \$1.25 EACH 10 FOR \$11.00

### POWER SUPPLY W/ PRE-AMP

THIS SUPPLY WAS USED TO POWER AN 8 TRACK/CASSETTE UNIT. IT WILL SUPPLY APPROX. 18 VDC AND INCLUDES A SMALL PRE-AMP TO BOOST SIGNAL LEVEL

RCA PLUGS FOR LINE IN/OUT

**\$4.50 EACH**



TOLL FREE ORDERS ONLY  
1-800-826-5432 (ORDER ONLY)  
(IN CALIFORNIA: 1-800-258-6666)  
ALASKA, HAWAII, OR INFORMATION  
(213) 380-8000

# ALL ELECTRONICS CORP.

905 S. Vermont Ave P.O. BOX 20406 Los Angeles, Calif. 90006

QUANTITIES LIMITED  
MINIMUM ORDER \$10.00  
USA: \$2.50 SHIPPING  
FOREIGN ORDERS  
INCLUDE SUFFICIENT SHIPPING  
CALIF. RES. ADD 6 1/2%  
NO C.O.D.

reversible phenomena. The Peltier effect is the one most useful in power supply design because of its ability to literally draw heat away from a semiconductor, although the Thomson effect also has some limited applications in these areas and will be discussed shortly.

Peltier cooling devices (fig. 5) may be attached directly to surfaces of heat-producing semiconductors. The effect of heat being drawn away in proportion to the current passing through the cooling device is what makes this device so effective, if somewhat expensive; a device large enough to handle a TO-3 power transistor is priced at about \$15.00.

Another interesting thermoelectric device is the Joule-Thomson cooler, as shown in fig. 6. Described by its manufacturer as a "micro-miniature refrigerator," it cools a wide range of IR (infrared) and millimeter wave detectors down to 77°K, or Kelvin, which is the temperature of liquid nitrogen (N<sub>2</sub>). Zero degrees Kelvin is *absolute zero* (where all molecular motion stops); this is equal to -273.15°C or -459.67°F. (One degree Kelvin equals in magnitude one degree Celsius, so to convert Kelvin to Celsius, just subtract 273.15 degrees from it. So 77°K = 77 - 273.15 = -196.15°C or -321.07°F.)

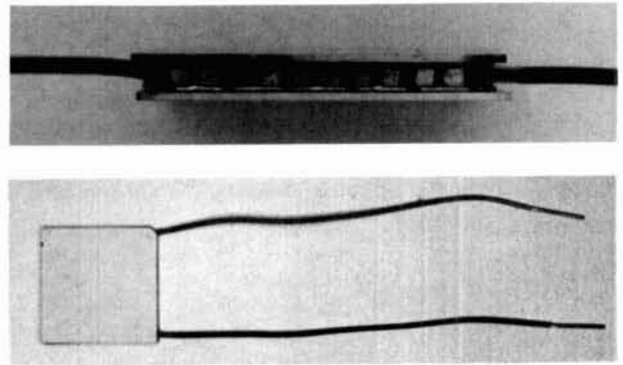
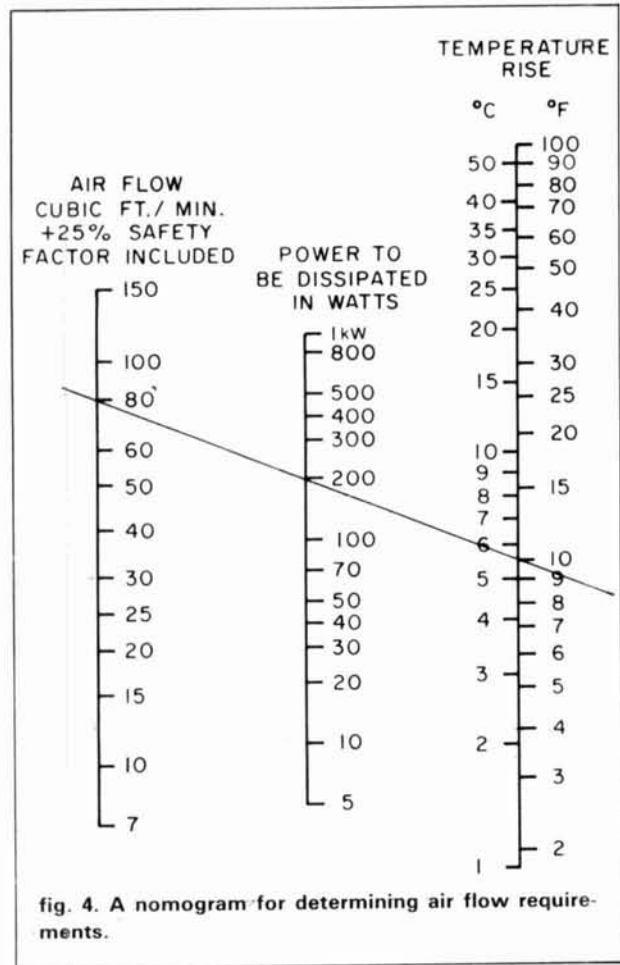

fig. 5. A Peltier cooling device (2 views).

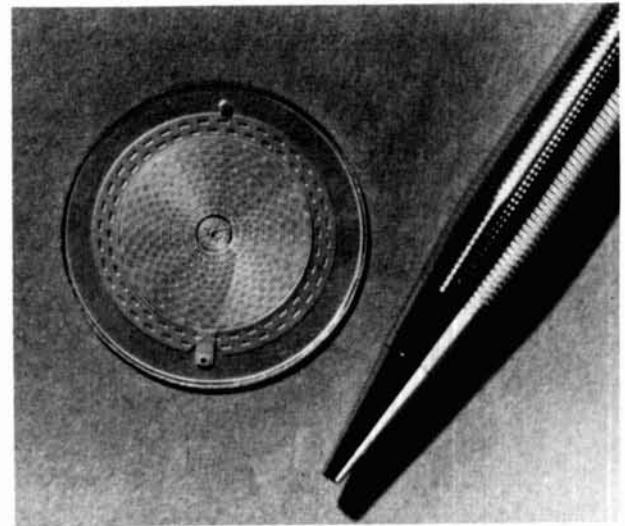
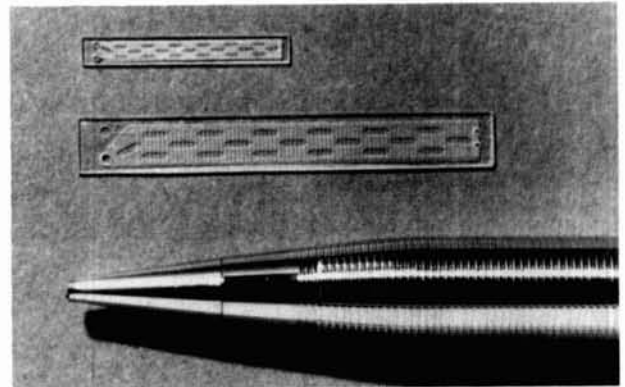

fig. 6. A Joule-Thomson cooler. (Photo courtesy MMR, Inc.)

These 1.5 cm (0.6 inch) in diameter devices can cool some detectors to 80°K (-193.15°C) in just one second.

### piezoelectric fan

Another interesting cooling device is the piezoelectrically driven fan designed for PC board use. Manufactured by Piezo Electric Products,\* this device (fig. 7)

\*Piezo Electric Products, 212 Durham Avenue, Metuchen, New Jersey 08840.



## AT LAST A MINIATURE BASE STATION AT A MINIATURE PRICE...

The MX-15 is a 15-meter band SSB/CW hand-held transceiver. It measures only 1 1/2" (D) x 2 5/8" (H) and offers 300mW for SSB and CW operation. A single-conversion receiver employing a MOS/FET front-end offers clear and sensitive reception. As a base or portable station, the MX-15 offers an unlimited challenge in QRP operation. Additional accessories are available to extend your operation.

The MX-15 comes with full 90 day warranty and is available from factory direct or HENRY RADIO (800) 421-6631



**\$129.95**



### ACCESSORIES SUPPLIED

- Standard Frequency crystal of your choice
- 6 pc. AAA Batteries
- DC Cable
- Instruction sheet

### ACCESSORIES AVAILABLE

- |  |         |
|--|---------|
| ■ MX Channel crystal... (Standard Frequency) | \$7.00  |
| ■ MS-1 External Speaker-Microphone           | \$23.50 |
| ■ Noise Blanker Kit                          | \$6.50  |
| ■ NB-1 Side Tone Kit                         | \$11.50 |
| ■ SP-15 Telescoping antenna                  | \$19.50 |
| ■ 2M2 DC-DC Converter set                    | \$17.50 |
| ■ PR-1 Mobile Rack Kit                       | \$23.50 |
| ■ VX-15 External VXO (one crystal supplied)  | \$53.50 |
| ■ PL-15 10W Linear amplifier                 | \$89.50 |



Photo shown MX-15, VX-15, PL-15, SP-15, MS-1 and PR-1

**ACE communications, inc.** 2832-D WALNUT AVENUE TUSTIN, CALIFORNIA 92680 17141 544-8281  
TELEX 655-306



## Brings You The PACKET Breakthrough!

PACKET RADIO lets you share a simplex channel error-free with up to 20 simultaneous users at 1200 Baud.

AEA introduces the MODEL PKT-1 PACKET CONTROLLER. Through an arrangement with TAPR (Tuscon Packet Radio, Inc.), AEA brings you the proven performance of the TAPR kit board and software in a rugged metal package, fully wired and tested with a full year's warranty and with all the free applications assistance you can stand.



Using only your existing radio and RS232 terminal (or computer), you can join the rapidly expanding packet radio community. Operate on VHF, HF or satellite and talk to more than 1000 existing packet users. Store messages addressed to you automatically and read them from your printer or monitor later. Easy to hook-up!! Easy to use!!

Call today for the rest of the story: 206-775-7373!!

Better yet, see your favorite AEA dealer.

Advanced Electronic Applications  
P.O. Box C-2160  
Lynnwood, WA 98036

All right, AEA, send me info fast!

To: AEA, P.O. Box C-2160,  
Lynnwood, WA 98036

Name \_\_\_\_\_

Address \_\_\_\_\_

City, State, Zip \_\_\_\_\_

Phone \_\_\_\_\_

Date \_\_\_\_\_

## ALL BAND TRAP ANTENNAS!

PRETUNED-ASSEMBLED ONLY ONE NEAT SMALL ANTENNA FOR ALL BANDS! EXCELLENT FOR APARTMENTS! IMPROVED DESIGN!

FOR ALL MAKES AMATEUR TRANSCEIVERS! GUARANTEED FOR 2000 WATTS SSB INPUT FOR NOVICE AND ALL CLASS AMATEURS!

COMPLETE with 90 ft. RG58U-52 ohm feedline, and PL259 connector, insulators, 30 ft. 300 lb. test dacron end supports, center connector with built in lightning arrester and static discharge. Low SWR over all bands - Tuners usually NOT NEEDED! Can be used as inverted V's - slopers - in attics, on building tops or narrow lots. The ONLY ANTENNA YOU WILL EVER NEED FOR ALL BANDS! NO BALUNS NEEDED!

80-40-20-15-10 -- 2 trap - 104 ft. - Model 998BUC .. \$99.95  
40-20-15-10 -- 2 trap -- 54 ft. - Model 1001BUC .. \$98.95  
20-15-10 meter - 2 trap - 26ft. - Model 1007BUC .. \$97.95

SEND FULL PRICE FOR POSTPAID INSURED. DEL. IN USA. (Canada is \$5.00 extra for postage - clerical - customs etc.) or order using VISA - MASTER CARD - AMER. EXPRESS. Give number and ex. date. Ph 1-308-236-5333 9AM - 6PM week days. We ship in 2-3 days. ALL PRICES MAY INCREASE SAVE - ORDER NOW! All antennas guaranteed for 1 year. 10 day money back trial if returned in new condition! Made in USA. FREE INFO. AVAILABLE ONLY FROM

WESTERN ELECTRONICS

Dept. AR- B

Kearney, Nebraska, 68847

## GROTH-Type

COUNTS & DISPLAYS  
YOUR TURNS



- 99.99 Turns
- One Hole Panel Mount
- Handy Logging Area
- Spinner Handle Available

Case: 2x4"; shaft 1/4"x3"

TC2 \$12.50

TC3 \$13.50

Spinner Handle Add \$1.50

Prices include UPS or Parcel Post in US

Model TC2: Skirt 2-1/8";

Knob 1-5/8"

Model TC3: Skirt 3";

Knob 2-3/8"

**R. H. BAUMAN SALES**

P.O. Box 122, Itasca, Ill. 60143

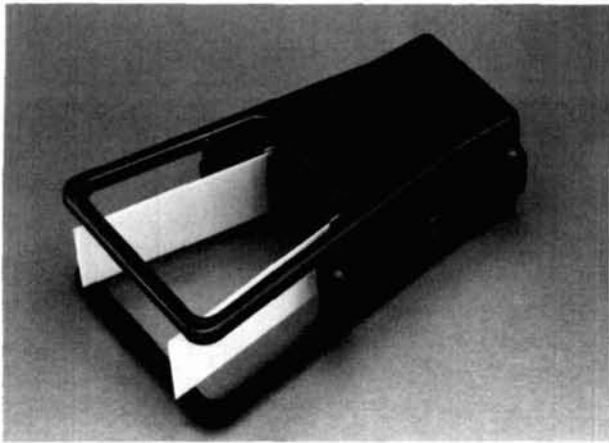

fig. 7. A piezoelectric fan. (Photo courtesy Piezo Electric Products, Inc.)

is available in either 50 or 60 Hz at 120 or 240 VAC. Used for spot cooling, it consumes about 1/15 of the power of a fan, yet accomplishes the same cooling effect. Its reliability is very high because of flexible metal strap blades laminated to thin-sheet piezoceramic elements. The mechanical vibrations that result when an AC voltage is applied across the piezoelectric element in the bender assembly cause the attached plastic blades to flap. This principle is illustrated in fig. 8. The highly "focused" air streams are responsible for the unit's exceptional efficiency; the fan moves 20 cubic feet/minute of air while using just 0.36 watts.

### the heat pipe

In size, heat pipes range from very small — about the size of a pipe cleaner (fig. 9) — to very large, as in furnace linings and factory smokestacks. The heat pipe's claim to fame is its unique ability to equally and uniformly distribute heat and thus equalize the differences between the hottest and coolest objects (usually ICs and ambient air, respectively). The smallest heat pipes fit nicely beneath and between the two adjacent rows of IC pins.

Heat pipes are metallic, sealed, self-contained units (fig. 10) with a thin outer wall or shell of copper which surrounds an internal wick saturated with a working fluid. As one end of the heat pipe (the evaporator end) is heated, the fluid within vaporizes and travels to the other end (the condenser end). As the vapor condenses, heat is given off and the vaporized liquid condenses and travels back, via capillary action, to the evaporator end. The end result is an efficient self-contained heat exchange system with the following advantages:

- The ability to transfer over 1000 times more heat than a copper rod of the same size and weight.
- Virtually absolutely uniform heat transfer and distribution throughout the heat pipe with less than 0.1 de-

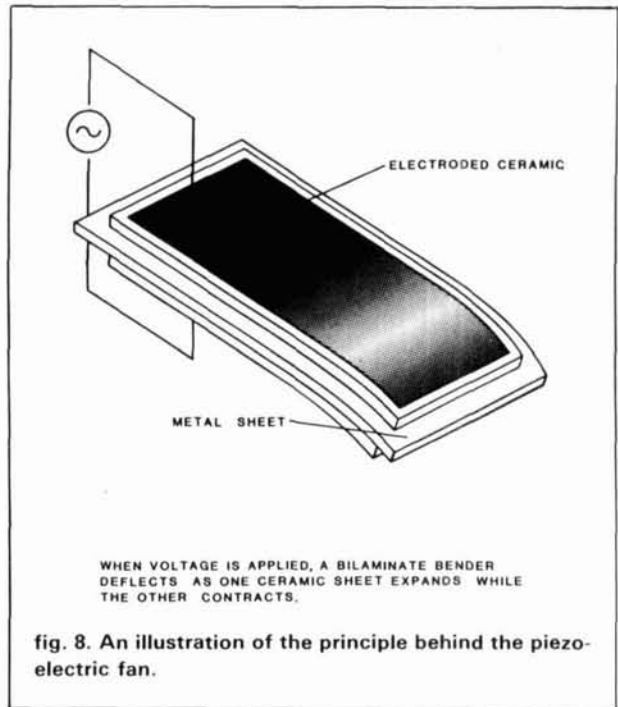

fig. 8. An illustration of the principle behind the piezoelectric fan.

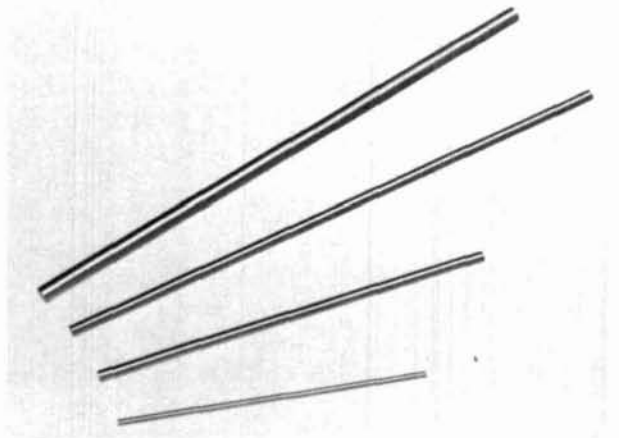
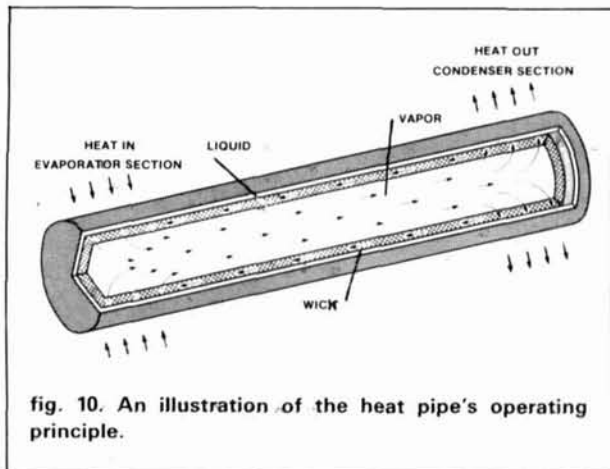

fig. 9. Typical small heat pipes. (Photo courtesy Noren Products, Inc.)

gree C drop or heat gradient from one end of the pipe to the other.

- Lightweight and compact.
- No moving parts, no maintenance or external power required.
- No noise — either electrical or audible.
- Capability of being fused to an existing heat sink (fig. 11).

If, for example, you had an LED display composed of a row of adjacent DIPs, and very poor or no ventilation, as in fig. 12, you wouldn't be able to use a slip-on DIP heat sink such as the one shown in fig. 13; slipping this heat sink over the DIP displays would obscure the front of the display, rendering it useless. In



applications such as this, a heat pipe is ideal. When it's necessary to vent heat away *after* it has been transferred and evenly distributed, a radiator, as shown in fig. 14, may be attached to the heat pipe.

### monitoring temperature

After heat sinks, heat pipes, and either a fan and/or a Peltier or Thomson-Joule device are added, the temperature should be within acceptable limits, and temperature monitoring should begin. A number of companies manufacture a crayon-like pen that can be used to apply a heat-sensitive substance to the surface of a semiconductor whose temperature is to be monitored (fig. 15). There are also TO-3, TO-66, and DIP stick-on temperature indicators (fig. 16) and other heat-sensitive products such as paints and tablets (fig. 17) that change colors in direct relation to the temperature they monitor; as the temperature changes, so does the color of the temperature indicator. These indicators are available in two types. The more traditional throwaway types change color as temperature rises, but if the temperature falls again, cannot change back to a color corresponding to this lower temperature. This unfortunate "ratchet" effect can be avoided by use of an LCD temperature indicator. Instead of the more traditional nematic crystals, these indicators use cholesteric crystals — produced in the cholesterol in lambs wool and cuttlefish<sup>1</sup> — and cost about four dollars each, feature as many as seven colors, and have 5-degree C temperature increments as standard. There are larger indicators based on the same principle that can cover whole power supplies or entire printed circuit boards.

### protection devices

In order for overheating to be controlled, it must first be sensed. The visual methods just described (shown in fig. 15 through 17) are one form of indicator; however, in unattended applications, electrical parameters, as well as heat, must be sensed and controlled. In a

typical power supply, there is a fuse at the transformer, but other protection can be provided for individual component parts within the system.

A PTC (positive temperature coefficient) thermistor can help. These devices are very inexpensive — about \$1 — and are two-lead devices that sense ambient heat by having the body or encapsulating cover experience heating, causing its resistance to rise by an order of magnitude (a factor of ten) for each 10 degree C rise in temperature above its trip point. This trip point is different per unit and can be specified, but a typical trip point is about 100 degrees C. Once this elevated

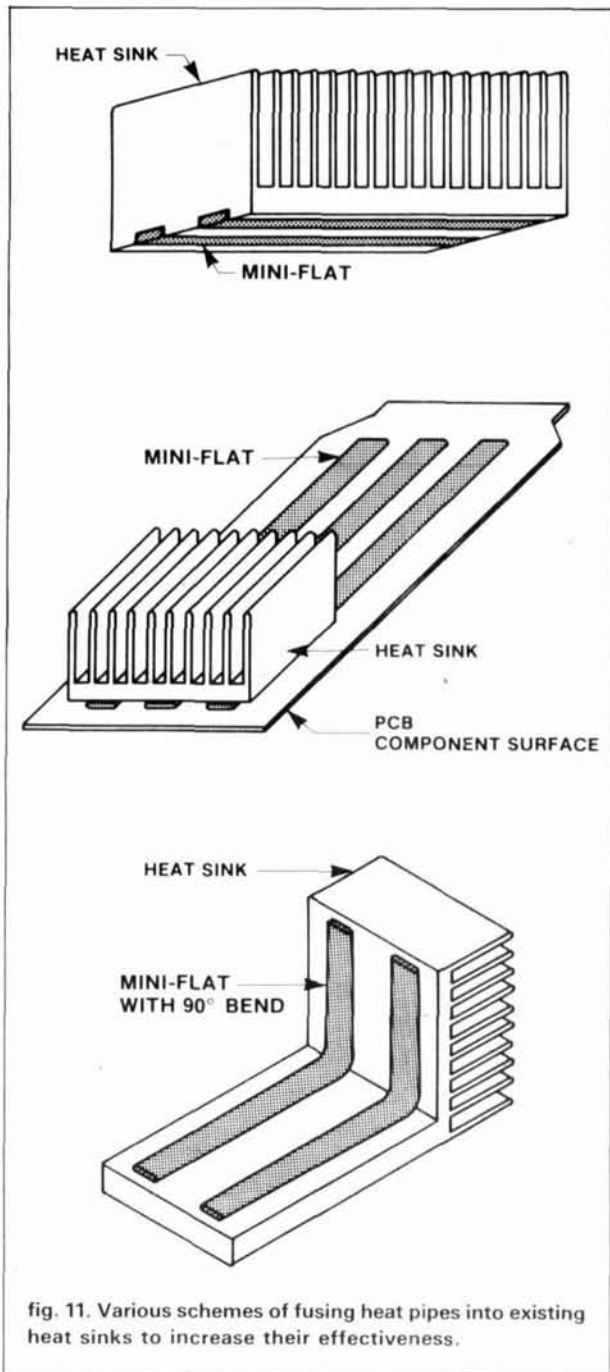

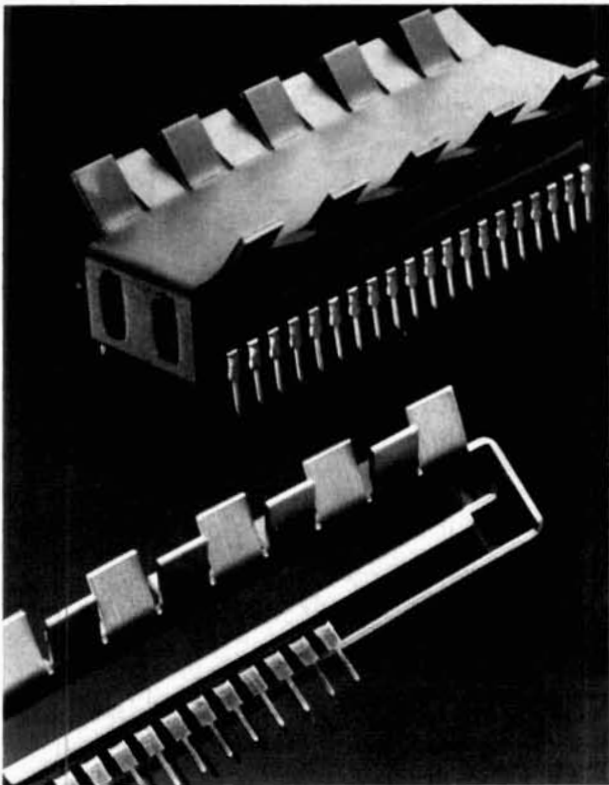
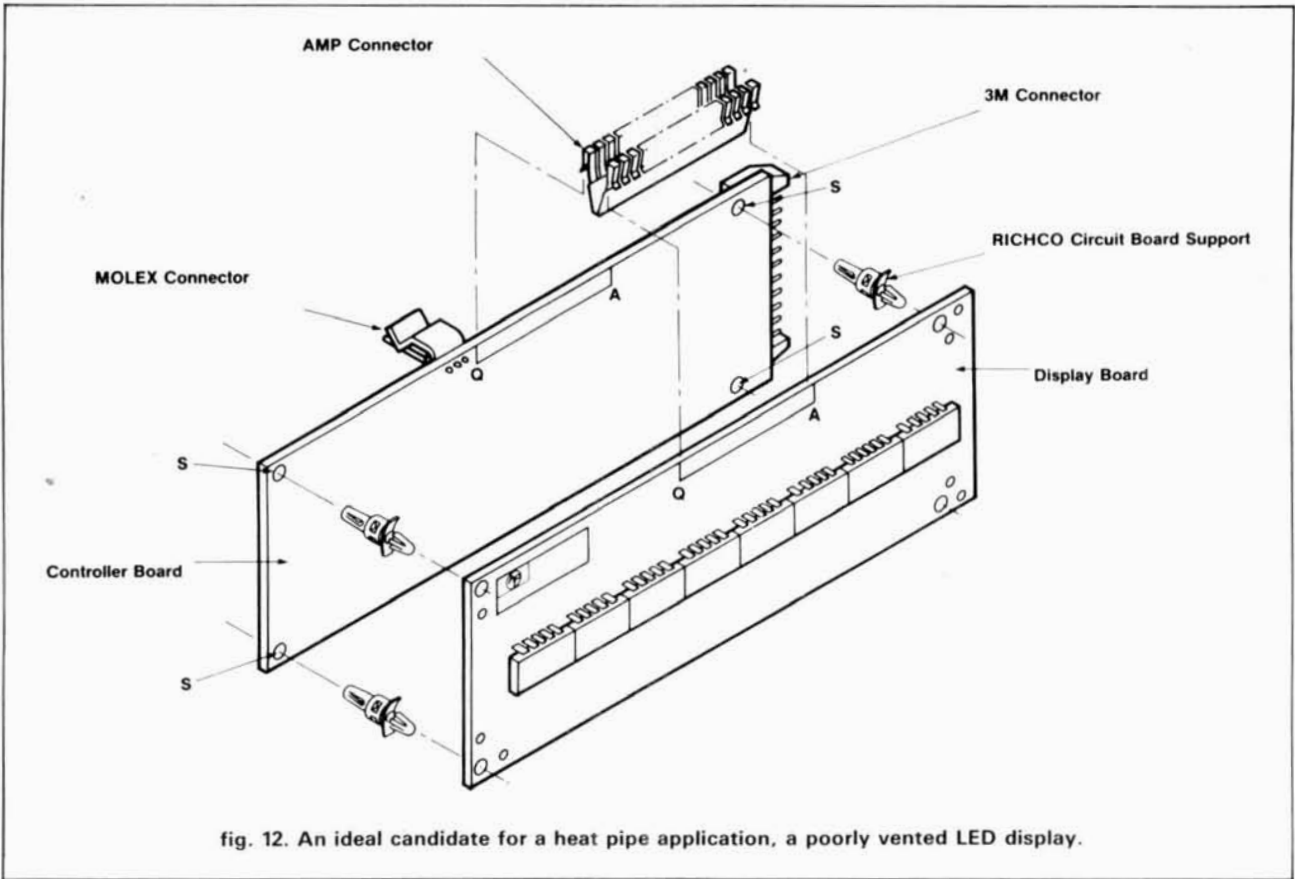

fig. 13. A DIP slip-on heat sink, unfortunately not useful in an application such as with the display in fig. 12. (Photo courtesy Aavid Engineering, Inc.)

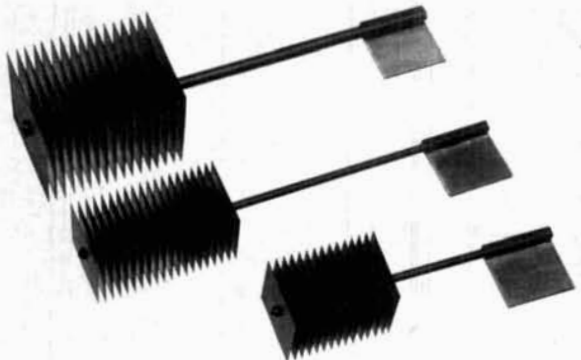

fig. 14. A "radiator" attached to a heat pipe for more effective heat radiation. (Photo courtesy Noren Products, Inc.)



fig. 15. Heat sensitive crayons used to visually detect temperature changes. (Photo courtesy Tempil Division, Big Three Industries, Inc.)

temperature is reached, though, automatic reset by merely removing power to the PTC thermistor is not possible. An actual cooling of the PTC thermistor to below its trip temperature must first occur before re-



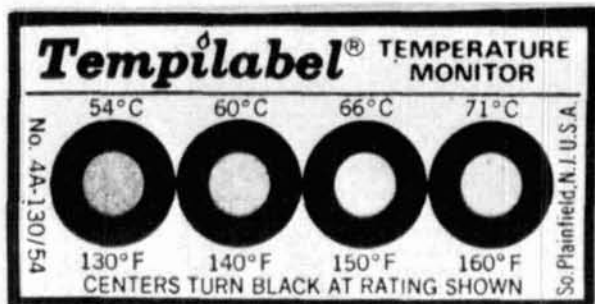

fig. 16. Heat sensitive sticky backed peel-off temperature indicators.



fig. 17. A whole product line of visual temperature indicators. (Photo courtesy Omega Engineering, Inc.)

setting is possible. The internal heating effect of the thermistor itself is inadequate to cause it to reach the trip temperature. This allows internal heating to have only a very small effect on the resistance of this heat sensitive resistor. It also allows the surface that is producing heat, usually flush with the PTC thermistor, to control the device's resistance. Fig. 18 is a graph showing how this internal heating effect is minimized by a PTC.

### summary

Though useful for the applications intended, heat sinks are not the only means of dissipating heat, especially within an equipment cabinet. Blowers and

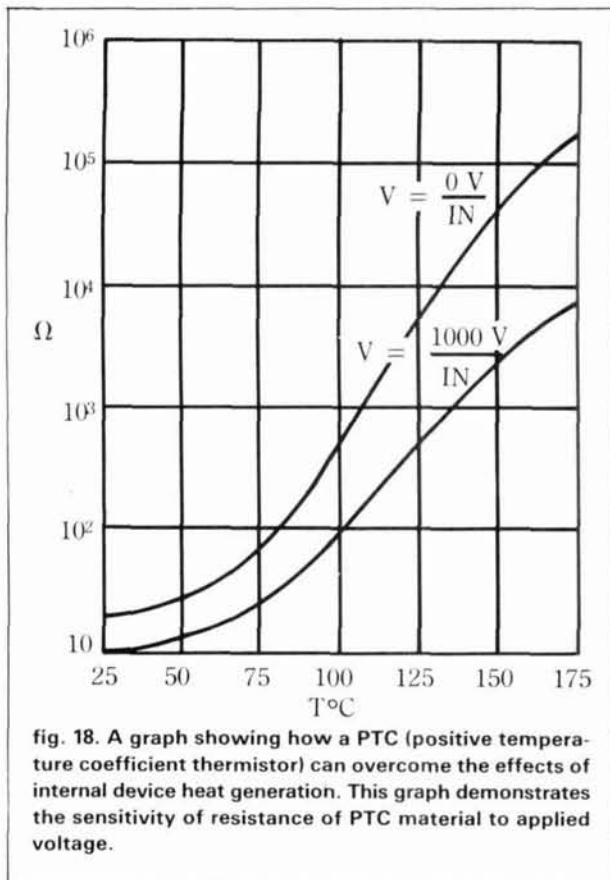

fig. 18. A graph showing how a PTC (positive temperature coefficient thermistor) can overcome the effects of internal device heat generation. This graph demonstrates the sensitivity of resistance of PTC material to applied voltage.

fans can be selected and sized to maintain specified temperature rises for a given power dissipation requirement. On a smaller scale, thermoelectric devices exhibiting the Seebeck, Thomson, Joule, or Peltier effect can be used to cool individual semiconductors. Heat pipes are also very effective in uniformly transferring heat from one location to another. The effectiveness of these devices can be determined by using temperature indicators in the form of stick-ons or paints. Overheating protection devices that generate voltages in a feedback loop can be used to reduce the original cause of heat buildup.

### reference

1. Vaughn D. Martin, "LCD Primer," *CQ*, April, 1983, page 45.

### bibliography

- Carbonell, Nelson P. and Nevela, David J., "Forced Air Cooling," *Electronic Products*, April, 1979, page 59.
- Chardon, Carlos C., "Design Equipment to Run Silent, Run Cool," *Electronic Design*, June 21, 1980, page 119.
- Martin, Vaughn D., "LCD Primer," *CQ*, April, 1983, page 45.
- Newberry, Deb, "Heat Pipes," *Circuits Manufacturing*, June, 1983, page 54.
- Rodriguez, Edward T., "Model Semiconductor Thermal Designs Even with Scanty Vendor Data," *Electronic Design*, February 15, 1979, page 102.
- Sass, Forrest, "Keep Cool and Live Longer," *Electronic Products*, May, 1980, page 55.
- Siegel, Bernard S., "Measuring Thermal Resistance is the Key to a Cool Semiconductor," *Electronics*, July 6, 1978, page 121.

ham radio





# Announces:

A User-Friendly Software Package  
Designed For Easy Operation of Morse,  
Baudot, ASCII, and AMTOR. A Feature-  
Packed Program Called:

# MBA-TOR™

## MAIN MENU SCREEN

hh:mm:ss

MBA-TOR™  
COPYRIGHT 1984 BY AEA

### SELECT:

- M. MORSE
- A. ASCII
- R. RTTY
- T. AMTOR
- U. AUTO AMTOR
- X. AUTO CALL
- C. COMMANDS
- O. OPTIONS

Now Available for the Commodore 64 Computer in Two Versions.  
MBA-TOR 64 Software Package Only, at \$119.95 Suggested Retail.  
MAP-64/2 Software with Self-Contained Interface \$239.95 Retail.

### Just Look At Some Of The Features:

- CW receive and transmit at 5 to 99 wpm, auto speed track on receive.
- 8 bit ASCII, receive and transmit at 110, 150 or 300 baud.
- 5 bit Baudot, receive and transmit at 60, 67, 75, 100 or 132 wpm.
- TOR, receive and transmit ARQ (Mode A) or FEC (Mode B) and listen.
- Beacon and WRU system, includes QRG check before XMT, won't QRM.
- Message forwarding system, AUTO-AMTOR still functions in this mode.
- Selects command menu.
- Selects options menu.

- + Complete precompose split-screen display with status information.
- + Complete printer control including SELCALL/WRU printer control.

## OPTIONS MENU SCREEN

hh:mm:ss

- I. CALLSIGN ??????
- S. SELCALL ?????
- T. ARQ TIMEOUT 30
- U. USOS ON
- M. MORSE FILL (BT) OFF
- R. RTTY SYNC (NUL) OFF
- A. AUDIO FEEDBACK OFF
- C. AUTO CR ON
- L. AUTO LF ON
- B. BEACON RECORD OFF
- W. WRAP-AROUND ON
- K. CW BREAK-IN OFF
- O. OUTPUT MODE WORD

- 24-hour clock, shows time in hours, minutes and seconds.
- Allows entry of your callsign for auto operations.
- Derived from your callsign automatically, can be changed.
- Sets ARQ phasing calls from 1 to 99 seconds.
- Unshift on space, toggles on or off.
- Transmits Morse idle character during breaks in KB activity.
- Transmits RTTY idle character during breaks in KB activity.
- Sends short beep through your audio as any key is depressed.
- Sends carriage return the first space after 65 characters.
- Sends a line feed after each carriage return.
- Allows the beacon to be recorded to the QSO buffer for logging.
- Sends CR/LF if there is a space in the last 5 positions on the line.
- Automatic transmit/receive switching during QSO.
- Transmit in word mode (text sent on space) or character mode.

- + Break-in buffer on all modes, toggle QSO buffer on or off.
- + CW speed lock and Farnsworth low-speed CW.
- + 10 soft-partitioned™ message buffers plus direct from disk or tape.

## COMMAND MENU SCREEN

hh:mm:ss

- L. LOAD
- E. EDIT
- M. MOVE
- S. SAVE
- X. SET XMT BUFFER SIZE
- C. SET COLOR
- T. SET TIME

- Allows loading of message or QSO buffers from disk or cassette.
- Word processor type edit functions on message and QSO buffers.
- Allows transmission of QSO buffer without disk or cassette systems.
- Allows you to save message and QSO buffers to disk or cassette.
- Set the transmit pre-type buffer to any size you like.
- Chose between any of 16 colors for character, screen or border.
- Lets you set the time of day clock.

- + Insert QSO station's call into any buffer while still copying.
- + Includes a complete manual, keyboard overlays and cables for the AEA Computer Patch™ or Micropatch™ Interface.
- + For more information call AEA, or see your AEA Dealer.

## C & A ROBERTS, INC.

18511 Hawthorne Blvd., Torrance, CA 90504  
213-370-7451 24 Hours call 213-834-5868

124

# AEA

**Brings you the Breakthrough!**

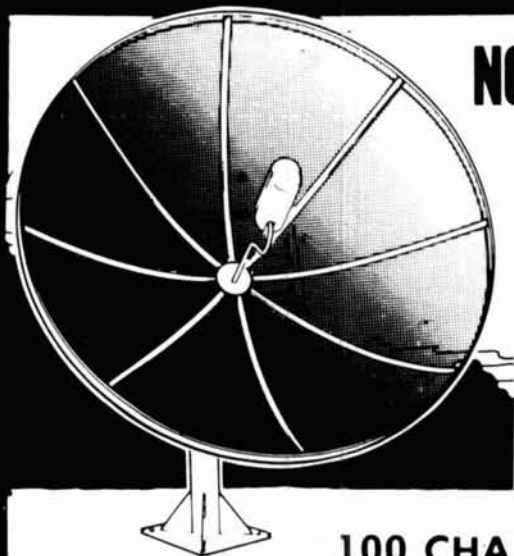

**NOBODY BEATS  
OUR  
PRICES!!!**

\$35.00 per  
month  
nothing down  
**FINANCING  
AVAILABLE**

**100 CHANNELS OF TV  
MOVIES • SPORTS • NEWS**

# J & J SATELLITE TV SYSTEMS

9504 Tara Blvd., Jonesboro  
404/477-1030 • 404/477-1238 ✓ 149



**FILTERS — BLANKERS  
AND CONVERTERS  
FOR THE SERIOUS  
AMATEUR**

**DISTRIBUTED EXCLUSIVELY BY**

**AllComm** 5717 NE 56TH  
SEATTLE, WA 98105  
(206) 641-7461

✓ 108

## HOBBY KITS®

EXPERIMENT — LEARN ELECTRONICS  
BUILD AND DESIGN YOUR OWN AM, FM, CW,  
OR SSB RECEIVERS, TRANSMITTERS AND ETC.  
WITH OUR MINI-LINEAR CIRCUIT KITS  
All kits Come Complete With Etched and Drilled Circuit Boards  
and All Parts Needed To Function As Described

AFA-1 AUDIO AMP. LM-380 1-2 Watts 4-16 OHM Output	\$4.95
AFP-1 AUDIO PREAMP, Dual Audio Preamp — For Mike Etc	\$3.95
BMD-1 BAL. MIX. LM 1496 Mixer — S-B Modulator Tuned Output	\$9.95
DET-1 AM DET., Am Envelope Detector With AGC Output	\$3.95
DET-2 FM DET., LM 3065 FM Detector (455 KHZ or 4-11 MHZ)	\$7.95
DET-3 SSB DET., LM 1496 SSB Detector (Needs OSC-1 or OSC-4)	\$9.95
DET-4 DETECTOR CW/SSB using a dual gate FET transistor	\$4.95
IFA-1 IF AMP., CA 3028 30 DB Gain, Optional AGC (455 KHZ or 9-11 MHZ)	\$6.95
FLS-9 SSB FILTER 9 MHZ/2.1 KHZ BW with USB XAL for OSC-1	\$49.95
IFA-2 IF AMP., CA 3028 30 DB Gain 1-100 MHZ Optional AGC	\$6.95
MBA-1 FREQ. MULT., Tuned Output Buffer-Mult-Amplifier To 250 MHZ	\$5.95
OSC-1 CRYSTAL OSC., 100 KHZ — 20 MHZ Not Tuned	\$3.95
OSC-2 CRYSTAL OSC., Ov. 18-200 MHZ Tuned Output	\$4.95
PSV-1 POWER SUPPLY LM 723 With Pass Transistor, 3 amps max	\$7.95
PLL-2 TONE DETECTOR LM567 PLL Tone Detector	\$5.95
RF/MIX-1 RF-AMP/MIXER CA 3028 — Tuned RF AMP/Mixer 1-100 MHZ	\$7.95
RF/MIX-2 RF-AMP/MIXER 3N204 Tuned RF AM/Mixer 1 — 250 MHZ	\$7.95
VCO-3 VARIABLE HI STAB. OSC., Varactor tuned, 400 to 600 KHz output	\$7.95
VCO-4 VARIABLE HI STAB OSC., Varactor tuned, 3 to 20 Mhz output	\$7.95

Add \$2.00 For Shipping & Handling — Send For FREE Brochure  
SEND \$2.00 FOR FULL MANUAL WITH CIRCUIT DIAGRAMS AND  
TYPICAL RECEIVER AND TRANSMITTER HOOK-UPS  
MANY OTHER MODULES AVAILABLE

**MORNING DISTRIBUTING CO.**

P.O. BOX 717, HIALEAH, FLA. 33011

✓ 164

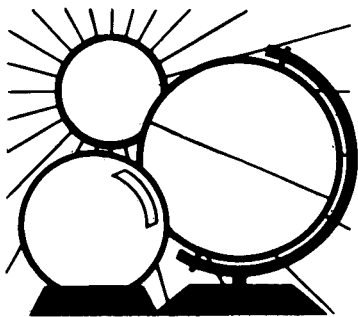

# DX FORECASTER

Garth Stonehocker, KØRYW

## summer noise

Summertime DX really isn't too bad on the higher frequency bands, 6-30 meters. Between sporadic-E short-skip openings near noontime and the bands staying open longer, enough DX fun is still available to keep us happy all day and well into the evening. The bands hardest hit by summertime problems are 80 and 160 meters of the lower-frequency bands. Their problem is summer thunderstorm noise — QRN.

Thunderstorm noise propagated from the equatorial regions increases the overall average noise level of the lower-frequency HF bands. At any given moment, 3600 storms are in progress around the world. That's a lot of QRN! Some, of course, are inevitably nearby.

Air-mass thunderstorms, which form only over land, build up from the hot summer sun's heating the ground and the air above it. They form in the afternoon if the humidity is above 50 percent, and last into the night before cooling off enough to dissipate. Unlike spring and fall frontal passage thunderstorms, which simply pass by your QTH, air-mass thunderstorms stay around for days until they release their moisture in the form of rain. During the evening DXing hours, the air-mass thunderstorm QRN more or less limits the usefulness of these band's signals to local ragchewing, and rule out weak-signal DX.

So how do you get some DXing in on these bands? Most operators switch operating hours, giving up evenings in favor of the pre-dawn hours of early morning. By this time, the thunderstorms have dissipated locally and are dissipating on paths to the west. This is a cool, comfortable time of the day to be up and around. Good luck, early bird!

## last-minute forecast

August is the last full month of summertime DX conditions, characterized mainly by sporadic-E short skip and longer daylight for high-frequency band DX operating. These higher frequencies are forecast to be best during the first two weeks of the month because of an expected high solar flux. The lower frequency bands, 30-160 meters, should improve during the last two weeks of the month because of lower noise and lower absorption of the signal's energy. This trend will become even more apparent next month.

The moon's perigee will occur on the 27th, with a full moon on the 11th. The Perseids meteor shower occurs from the 10th to 14th, with its maximum on the 11th and 12th, with better than fifty meteors per hour. This is an excellent shower.

## band-by-band summary

*Six-meter* paths will open for a half hour to a couple of hours on some

days around local noon. Sporadic-E propagation will make this short-skip path possible out to nearly 1200 miles (2000 km) per hop.

*Ten, fifteen, twenty, and thirty meters* will support DX propagation from most areas of the world during daylight and into the evening with long-skip out to 2000 miles (3500 km) per hop. Sporadic-E short skip will also be available on many days for several hours near local noon. The direction of propagation will follow the sun across the sky: morning to the east, south at midday, and toward the west in the evening. Daylight is still long, providing many hours of good DXing.

*Thirty, forty, eighty, and one-sixty meters* are the nighttime DXer's bands. On many nights 30 and 40 meters will be the only usable bands because of thunderstorm QRN. Try the pre-dawn hours for less QRN. The direction of propagation follows the darkness path across the sky: evening to the east, south around midnight, and toward the west in the pre-dawn hours. Distances will decrease to 1000 miles (1600 km) for skip on these bands. Sporadic-E openings will be most frequently observed around sunrise and sunset. These may be the only signals getting through the noise in the evening.

ham radio

GMT	WESTERN USA									
	PDT	N	NE	E	SE	S	SW	W	NW	
0000	5:00	20	20	15	10	15	10	10	20	
0100	6:00	20	20	20*	10	15	10	10	20	
0200	7:00	20	20	20	10	20	10	10	20	
0300	8:00	20	20	20	10	20	10	10	20*	
0400	9:00	20	20	20	10	20	15	10	20*	
0500	10:00	20	20	20	10	20	15	10	20	
0600	11:00	20	20	20	15	20	15	15	20	
0700	12:00	20	20	20	15	30	15	15	20	
0800	1:00	20	30	20	15	30	20	15	20	
0900	2:00	20	30	20	20	30	20	20	20	
1000	3:00	20	30	20	20	30	20	20	20	
1100	4:00	20	30	20	20	30	20	20	30	
1200	5:00	20	30	20	20	30	20	20	30	
1300	6:00	20	30	15	20	30	20	20	30	
1400	7:00	30*	20	15	20	30	20	20	30	
1500	8:00	30*	20	15	20	20	20	20	30	
1600	9:00	30*	20	15	20	20	15	20	30	
1700	10:00	30*	20	15	20	20	15	20	20	
1800	11:00	30*	20	10	20	20	15	20	20	
1900	12:00	30*	20	10	15	20	15	15	20	
2000	1:00	20	20	10	15	20	15	15	20	
2100	2:00	20	20	10	15	20	10	15	20	
2200	3:00	20	20	15	15	20*	10	15	20	
2300	4:00	20	20	15	15	15	10	15	20	

GMT	MID USA									
	MDT	N	NE	E	SE	S	SW	W	NW	
0000	6:00	20	20	15	15	15	10	10	20	
0100	7:00	20	20	20*	15	20	10	10	20	
0200	8:00	20	20	20	20	20	10	10	20	
0300	9:00	20	20	20	20	20	10	10	20	
0400	10:00	20	20	20	20	20	15	10	20	
0500	11:00	20	20	20	20	20	15	15	20	
0600	12:00	20	20	20	20	20	15	15	20	
0700	1:00	20	30	20	20	30	20	15	20	
0800	2:00	20	30	20	20	30	20	15	20	
0900	3:00	20	30	20	20	30	20	15	20	
1000	4:00	20	30	20	20	30	20	15	20	
1100	5:00	20	30	20	20	30	20	20	30	
1200	6:00	20	30	20	20	30	20	20	30	
1300	7:00	20	30	20	20	30	20	20	30	
1400	8:00	20	20	15	15	30	20	20	30	
1500	9:00	20	20	15	15	20	20	20	30	
1600	10:00	20	20	15	15	20	15	20	30	
1700	11:00	20	20	15	10	20	15	20	20	
1800	12:00	20	20	10	10	20	15	20	20	
1900	1:00	30*	20	10	10	20	15	20	20	
2000	2:00	20	20	10	10	20	15	15	20	
2100	3:00	20	20	10	10	20	15	15	20	
2200	4:00	20	20	15	15	20	15	15	20	
2300	5:00	20	20	15	15	15	10	15	20	

GMT	EASTERN USA									
	EDT	N	NE	E	SE	S	SW	W	NW	
0000	8:00	20	20	15	15	20	10	10	20	
0100	9:00	20	20	20*	20	20	10	10	20	
0200	10:00	20	20	20	20	20	10	10	20	
0300	11:00	20	20	20	20	20	15*	10	20	
0400	12:00	20	20	20	20	20	15	10	20	
0500	1:00	20	30*	20	20	20	15	15	20	
0600	2:00	20	30	20	20	20	15	15	20	
0700	3:00	20	30	20	20	30	20	15	20	
0800	4:00	20	30	20	20	30	20	15	20	
0900	5:00	20	30	20	20	30	20	20	20	
1000	6:00	20	30	20	20	30	20	20	30	
1100	7:00	20	30	20	15	30	20	20	30	
1200	8:00	20	30*	15	15	30	20	20	30	
1300	9:00	20	20	15	15	30	20	20	30	
1400	10:00	20	20	15	15	30	20	20	30	
1500	11:00	20	20	15	15	30	20	20	30	
1600	12:00	20	20	15	10	20	15	20	30	
1700	1:00	20	20	10	10	20	15	20	20	
1800	2:00	20	20	10	10	20	15	15	20	
1900	3:00	20	20	10	10	20	15	15	20	
2000	4:00	20	20	10	10	20	15*	15	20	
2100	5:00	20	20	10	10	20	10	15	20	
2200	6:00	20	20	15	15	20	10	15	20	
2300	7:00	20	20	15	15	15	10	15	20	

The italicized numbers signify the bands to try during the transition and early morning hours, while the standard type provides the MUF during 'normal' hours.  
 \*Look at next higher band for possible openings.

# TNT RADIO SALES INC.

1-800-328-0250

1-612-535-5050

(IN MINNESOTA—COLLECT)

## YOU GET MORE "BANG FOR YOUR BUCK" AT TNT RADIO SALES!

- |              |                |               |             |
|--------------|----------------|---------------|-------------|
| ■ Kenwood    | ■ Mirage       | ■ MFJ         | ■ Welz      |
| ■ Icom       | ■ KLM          | ■ Astron      | ■ Azden     |
| ■ Bencher    | ■ Telex Hygain | ■ Alpha/Delta | ■ Santec    |
| ■ AEA        | ■ Nye Viking   | ■ Bearcat     | ■ KDK       |
| ■ Kantronics | ■ Larsen       | ■ Regency     | ■ Ameritron |

### August/September Special—BUTTERNUT HF6V \$107.00

SALES AND SERVICE AT PRICES YOU CAN AFFORD!  
CALL OUR WATS LINE FOR LOW LOW PRICES!

VISA/MASTER CARD  
FREE SHIPPING  
ON MOST RIGS FOR CASH!



S.A.S.E. FOR OUR  
"BENCH-TESTED"  
USED EQUIPMENT LISTING

MONDAY - SATURDAY  
9 AM to 6 PM CENTRAL TIME

4124 West Broadway, Robbinsdale, MN 55422 (Mpls./St. Paul)

188

### TROUBLESHOOTING MICROPROCESSOR-BASED EQUIPMENT AND DIGITAL DEVICES

Attend this \*highly acclaimed seminar and master the essentials of microprocessor maintenance. Gain a firm understanding of microprocessor fundamentals and learn specialized troubleshooting techniques. \$695.00

#### 1984 FALL/WINTER SCHEDULE

- Washington, DC - September 11-14
- Boston - September 18-21
- Phoenix - October 9-12
- Los Angeles - October 16-19
- Atlanta - November 6-9
- Miami - November 13-16

\*References provided upon request.

**MICRO SYSTEMS INSTITUTE**  
Garnett, Kansas 66032  
(913) 898-3265

159

## RADIO EXPO 84 HAMFEST

sponsored by

Chicago FM Club

September 22 & 23

Lake County Fairgrounds  
Grayslake, IL Rts. 45 & 120

Giant Outdoor Flea Market

Reserved Indoor Tables — \$5.00 ea/day

Major Manufacturers Exhibits

Tech talks — Seminars — Ladies' Programs

Tickets good for both days

\$3.00 advance — \$4.00 at gate

SASE to RADIO EXPO 84  
BOX 1532

Evanston, IL 60204  
(312) 582-6923

## NEW FROM NEMAL

your one stop coax supplier!

### HARDLINE

Two styles, two sizes for all installation needs

- Aluminum Outer Conductor with Polyethylene Jacket
 

1/2 inch loss	48 dB/100 ft. @ 30 MHz	
	3.68 dB/100 ft. @ 1000 MHz	.....\$1.25/ft.
7/8 inch loss	28 dB/100 ft. @ 30 MHz	
	2.54 dB/100 ft. @ 1000 MHz	.....\$3.25/ft.
  - Corrugated Copper Outer Conductor with Polyethylene Jacket
 

1/2 inch loss	.38 dB/100 ft. @ 30 MHz	
(FLC12-50J)	2.78 dB/100 ft. @ 1000 MHz	.....\$1.59/ft.
7/8 inch loss	.13 dB/100 ft. @ 30 MHz	
(FLC12-78J)	1.3 dB/100 ft. @ 1000 MHz	.....\$3.92/ft.
- COMPARE RG 213 1.25 dB/100 @ 30 MHz  
8.5 dB/100 @ 1000 MHz !

### HARDLINE CONNECTORS

- |                           |         |            |         |
|---------------------------|---------|------------|---------|
| 1/2 inch aluminum UHF M/F | \$19.00 | Type N M/F | \$22.00 |
| 7/8 inch aluminum UHF M/F | \$49.00 | Type N M/F | \$49.00 |
| 1/2 inch copper UHF M/F   | \$22.00 | Type N M/F | \$22.00 |
| 7/8 inch copper UHF M/F   | \$49.00 | Type N M/F | \$49.00 |

Call or write for Free Catalog

shipping  
Cable — \$6.00 per 100 ft.  
Connectors — \$3.00 per order.  
Orders under \$20 add \$2 additional plus shipping.  
COD add \$2.00. Florida Residents add 5%.

### NEMAL ELECTRONICS

Dept. H, 12240 N.E. 14th Ave., N. Miami, FL 33161  
Telephone: (305) 893-3924

171



SAY  
YOU SAW  
IT IN

ham  
radio  
magazine



## ASTRON POWER SUPPLIES

• HEAVY DUTY • HIGH QUALITY • RUGGED • RELIABLE •

### RS and VS SERIES

#### SPECIAL FEATURES

- SOLID STATE ELECTRONICALLY REGULATED
- FOLD-BACK CURRENT LIMITING Protects Power Supply from excessive current & continuous shorted output.
- CROWBAR OVER VOLTAGE PROTECTION on all Models except RS-4A.
- MAINTAIN REGULATION & LOW RIPPLE at low line input Voltage.
- HEAVY DUTY HEAT SINK • CHASSIS MOUNT FUSE
- THREE CONDUCTOR POWER CORD
- ONE YEAR WARRANTY • MADE IN U.S.A.

#### PERFORMANCE SPECIFICATIONS

- INPUT VOLTAGE: 105 - 125 VAC
- OUTPUT VOLTAGE: 13.8 VDC  $\pm$  0.05 volts (Internally Adjustable: 11-15 VDC)
- RIPPLE: Less than 5mv peak to peak (full load & low line)

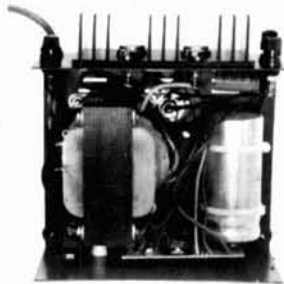

INSIDE VIEW - RS-12A



MODEL RS-50A



MODEL RS-50M



MODEL VS-50M

### RM-A Series



MODEL RM-35A

#### 19" X 5 1/2" RACK MOUNT POWER SUPPLIES

Model	Continuous Duty (AMPS)	ICS* (AMPS)	Size (IN) H X W X D	Shipping Wt. (lbs.)
RM-35A	25	35	5 1/4 x 19 x 12 1/2	38
RM-50A	37	50	5 1/4 x 19 x 12 1/2	50

### RS-A SERIES



MODEL RS-7A

MODEL	Continuous Duty (Amps)	ICS* (Amps)	Size (IN) H x W x D	Shipping Wt (lbs)
RS-4A	3	4	3 3/4 x 6 1/2 x 9	5
RS-7A	5	7	3 3/4 x 6 1/2 x 9	9
RS-7B	5	7	4 x 7 1/2 x 10 3/4	10
RS-10A	7.5	10	4 x 7 1/2 x 10 3/4	11
RS-12A	9	12	4 1/2 x 8 x 9	13
RS-20A	16	20	5 x 9 x 10 1/2	18
RS-35A	25	35	5 x 11 x 11	27
RS-50A	37	50	6 x 13 3/4 x 11	46

### RS-M SERIES



MODEL RS-35M

- Switchable volt and Amp meter

MODEL	Continuous Duty (Amps)	ICS* (Amps)	Size (IN) H x W x D	Shipping Wt (lbs)
RS-12M	9	12	4 1/2 x 8 x 9	13
RS-20M	16	20	5 x 9 x 10 1/2	18
RS-35M	25	35	5 x 11 x 11	27
RS-50M	37	50	6 x 13 3/4 x 11	46

### VS-M SERIES



MODEL VS-20M

- Separate Volt and Amp Meters
- Output Voltage adjustable from 2-15 volts
- Current limit adjustable from 1.5 amps to Full Load

MODEL	Continuous Duty (Amps) @13.8VDC@10VDC@5VDC	ICS* (Amps) @13.8V	Size (IN) H x W x D	Shipping Wt (lbs)
VS-20M	16 9 4	20	5 x 9 x 10 1/2	20
VS-35M	25 15 7	35	5 x 11 x 11	29
VS-50M	37 22 10	50	6 x 13 3/4 x 11	46

### RS-S SERIES



MODEL RS-12S

- Built in speaker

MODEL	Continuous Duty (Amps)	ICS* Amps	Size (IN) H x W x D	Shipping Wt (lbs)
RS-7S	5	7	4 x 7 1/2 x 10 3/4	10
RS-10S	7.5	10	4 x 7 1/2 x 10 3/4	12
RS-10L(For LTR)	7.5	10	4 x 9 x 13	13
RS-12S	9	12	4 1/2 x 8 x 9	13
RS-20S	16	20	5 x 9 x 10 1/2	18

# THE CHAMP



BIRD MODEL 4304

**NO ELEMENTS  
25-1000 MHZ  
RF SAMPLING PORT**

AUTHORIZED **BIRD** DISTRIBUTOR



WEBSTER COMMUNICATIONS INC.  
115 BELLARMIN  
ROCHESTER, MI 48063  
313-375-0420

CALL TOLL FREE

**800-521-2333  
800-482-3610**

✓ 196

## 1984 THE RADIO AMATEUR'S HANDBOOK



Published by the American Radio Relay League

### STATE OF THE ART

The 1984 Edition of *The Radio Amateur's Handbook* carries on the tradition of the previous editions by presenting 640 pages of comprehensive information for the radio amateur, engineer, technician and student. Paper edition: **\$12** in the U.S., **\$13** in Canada, **\$14.50** elsewhere. Cloth: **\$17.75** in the U.S., **\$20** elsewhere. In U.S. funds.

THE AMERICAN RADIO RELAY LEAGUE  
225 MAIN ST.  
NEWINGTON, CT 06111

✓ 113

More Details? CHECK—OFF Page 140

# RF TRANSISTORS

FRESH STOCK - NOT SURPLUS  
TESTED — FULLY GUARANTEED

P/N	Rating	Ea.	Match Pr
MRF406	20W	\$14.50	\$32.00
MRF412	80W	18.00	40.00
MRF412A	80W	18.00	40.00
MRF421	100W	25.00	54.00
MRF421C	110W	27.00	58.00
MRF422*	150W	38.00	82.00
MRF426*	25W	17.00	40.00
MRF426A*	25W	17.00	40.00
MRF433	13W	14.50	32.00
MRF435*	150W	42.00	90.00
MRF449	30W	12.00	27.00
MRF449A	30W	11.00	25.00
MRF450	50W	12.00	27.00
MRF450A	50W	12.00	27.00
MRF453	60W	15.00	33.00
MRF453A	60W	15.00	33.00
MRF454	80W	16.00	35.00
MRF454A	80W	16.00	35.00
MRF455	60W	12.00	27.00
MRF455A	60W	12.00	27.00
MRF458	80W	18.00	40.00
MRF460	60W	16.50	36.00
MRF475	12W	3.00	9.00
MRF476	3W	2.50	8.00
MRF477	40W	13.00	29.00
MRF479	15W	10.00	23.00
MRF485*	15W	6.00	15.00
MRF492	90W	18.00	39.00
SRF2072	75W	15.00	33.00
CD2545	50W	24.00	55.00

Selected High Gain Matched Quads Available

### VHF TRANSISTORS

Type	Rating	Ea.	Match/Pr
MRF221	15W	\$10.00	—
MRF222	12W	12.00	—
MRF224	40W	13.50	\$32.00
MRF231	3.5W	10.00	—
MRF234	25W	15.00	39.00
MRF237	1W	2.50	—
MRF238	30W	12.00	—
MRF239	30W	15.00	—
MRF240	40W	16.00	—
MRF245	80W	25.00	59.00
MRF247	80W	25.00	59.00
MRF260	5W	6.00	—
MRF264	30W	13.00	—
MRF492	70W	18.00	39.00
MRF607	1.8W	2.60	—
MRF627	0.5W	9.00	—
MRF641	15W	18.00	—
MRF644	25W	23.00	—
MRF646	40W	24.00	59.00
MRF648	60W	29.50	69.00
SD1416	80W	29.50	—
SD1477	125W	37.00	—
2N4427	1W	1.25	—
2N5945	4W	10.00	—
2N5946	10W	12.00	—
2N6080	4W	6.00	—
2N6081	15W	7.00	—
2N6082	25W	9.00	—
2N6083	30W	9.50	—
2N6084	40W	12.00	29.00

### TMOS FET

MRF137	30W	\$22.50	—
MRF138	30W	35.00	—
MRF140	150W	92.00	—
MRF150	150W	80.00	—
MRF172	80W	65.00	—
MRF174	125W	88.00	—

Technical Assistance & cross-reference information on CD, PT, RF, SRF, SD P/Ns Call Engineering Dept. (619) 744-0728

RF Parts Catalog Available ✓ 197  
OEM & Quantity Discounts

Minimum Order \$20 Add \$3.50 Shipping  
WE SHIP SAME DAY C.O.D./VISA/MC

ORDERS ONLY: 800-854-1927



## WESTCOM

1320 Grand Ave. San Marcos  
California 92069 (619) 744-0728

## MOSLEY...A Better Antenna... For New and Old

\*EASY ASSEMBLY \*2 YEAR WARRANTY  
\*NO MEASURING \*LOW SWR  
\*ALL STAINLESS HARDWARE \*BUILT TO LAST

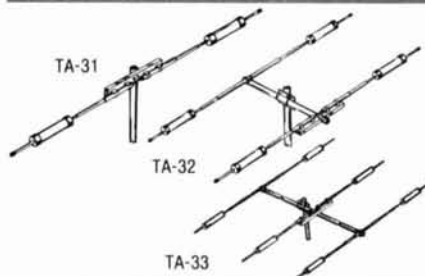

Whether you are just starting out or trying to complete the Honor Roll, Mosley offers a Full Line of Tri-Banders which will mechanically and electronically outperform the competition. For the new ham with limited space and pocket book, start with our TA-31 Jr. rotatable dipole. You can make our TA-31 Jr. into a 2 or 3 element as your needs increase.

If you start with the need to run higher power, then the TA-31 is for you. This also can be made into a 2 or 3 element beam as you expand your station.

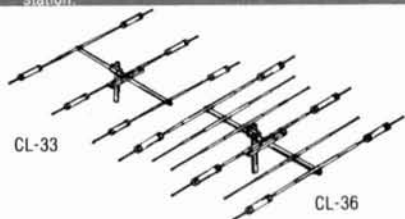

For the ham that wants a little more performance out of a Tri-Bander but is limited in room, then our CL-33 on a 18 foot boom is the way to go. For those that want MONO BAND performance out of a Tri-Bander, want to hear better, and be louder, the CL-33 is for you.



For the ham that wants to start right at the top, the PRO-37 is the antenna that will give you king of the hill performance. It is the broadest banded, highest power, best performing Tri-Bander in our line.

Compare ours before buying any other antenna. All stainless standard, all heavy telescoping aluminum elements which means better quality and no measurement. Ease of assembly gives you a quality antenna with consistent performance. Our elements are pre-drilled so you will get the same performance as we do. All of our Tri-Banders come with a 2 year warranty.

If you are a new ham and are not familiar with MOSLEY, ask an older ham about us or call the PRESIDENT of MOSLEY. He will be glad to explain why MOSLEY IS A BETTER ANTENNA.

These and other MOSLEY products are available through your favorite DEALER. Or write or call MOSLEY for the DEALER nearest you.



1344 BAUR BLVD. ST. LOUIS, MISSOURI 63132

✓ 165

August 1984 **74** 67

# Kantronics Interface II

The Interface For  
*Apple, Atari, TI-99/4A, TRS-80C,*  
*VIC-20, and Commodore 64*  
Computers

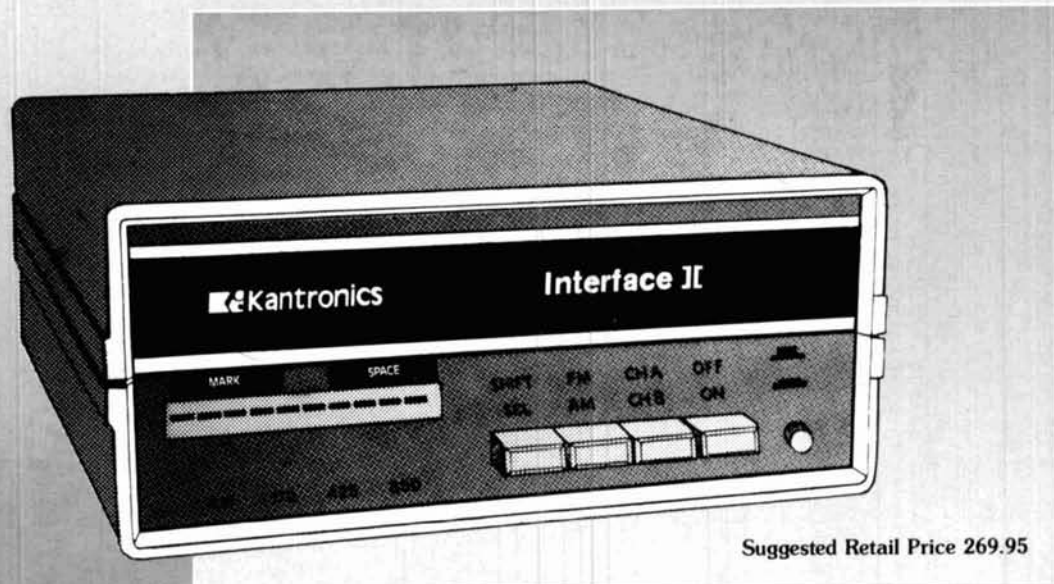

Suggested Retail Price 269.95

Interface II is the new Kantronics transceiver-to-computer interface. Interface II features a highly sensitive front end with mark and space filtering. Even the most discerning operator will be surprised with the Interface II's ability to dig out signals in poor band conditions. Our unique tuning system even displays signal fading.

X-Y scope outputs and dual interface outputs for VHF and HF connections make Interface II compatible with almost any shack. All three standard shifts are selectable, and Interface II is AMTOR compatible. Interface II is designed for use with Kantronics software.

## Kantronics Software — The Industry Standard

### Hamsoft

Our original program for reception and transmission of CW/RTTY/ASCII. Features include Split Screen Display, Message Ports, Type-ahead buffer, and printer compatibility. Apple Diskette \$29.95, VIC-20 cartridge \$49.95, Atari board \$49.95, TRS-80C board \$59.95, TI-99/4A cartridge \$99.95.

### Hamtext

All the features of Hamsoft with the following additional capabilities: text editing, received message storage, variable buffer sizes, diddle, word wraparound, time transmission, and text transmission from tape or disc. The program is available on cartridge for the VIC-20 or Commodore 64, and diskette for the Apple. Suggested Retail \$99.95.

### Hamsoft/Amtor

This program has Hamsoft features with the added ability of communicating in the newest coded amateur format-AMTOR. AMTOR offers error free low power communication. Hamsoft/Amtor is available for the Atari, TRS-80C, VIC-20, and Commodore 64 computers. Suggested Retail \$79.95.

### Amtorsoft

For the serious AMTOR operator using a VIC-20, Commodore 64, or Apple computer. This program is similar to Hamtext in capabilities, but can only be used for AMTOR. The Apple version includes both Hamtext and Amtorsoft on one diskette (\$139.95), while the Vic-20 and Commodore 64 cartridge is just Amtorsoft (\$89.95).

# Kantronics UTU

## The Universal Terminal Unit For Everyone Else



Suggested Retail Price 199.95

### KANTRONICS SETS A NEW STANDARD WITH THE KANTRONICS UNIVERSAL TERMINAL UNIT.

UTU allows any computer with an RS232 port and a terminal program to interface with any transceiver. Additional software isn't necessary with UTU, as an internal microcomputer gives the unit data processing capabilities to send and receive in four coded amateur formats; Morse code, Radioteletype, ASCII, and AMTOR.

Sample terminal programs for IBM, TRS-80 Model III and IV, Kaypro, and other computers are included in the manual. Enhanced features can be user defined by altering the terminal program, giving you

flexibility to program for your specific needs.

The Kantronics Universal Terminal Unit can send and receive CW at 6-99 WPM; RTTY 60, 67, 75, 100, and 132 WPM; ASCII 110, 150, 200, and 300 baud; and AMTOR. Dual tone detection and our unique bargraph tuning system make tuning fast and easy. Additional LEDs indicate Lock and Valid status during AMTOR operation. The RS232 port is TTL or RS232 level compatible.

If you've been waiting for a Kantronics system for your computer, the wait is over.

For more information contact an **Authorized Kantronics Dealer,**

or write: **Kantronics**

1202 E. 23rd Street  
Lawrence, Kansas 66044



## ANTENNA SALE

## BEARCAT SPECIAL SALE

### HY-GAIN

### HY-GAIN TOWERS

### CUSHCRAFT

TH3RJS	\$169
TH5MK2S	\$355
TH7BX3S	\$410
EXPLORER 14	\$269
14AVQB	\$59
18AVT/WBS	\$95
V2S	\$37
V3	\$40
V4	\$49
66BS	\$109
CD45 II	\$125
HAM IV	\$199
T2X	\$245
ALLIANCE HD73	\$99

HG37SS	\$629
HG50MT2	\$739
HG52SS	\$899
HG54HD	\$1449
HG70HD	\$2269

A-3	\$209
A-4	\$279
40-2CD	\$279
R-3	\$265
AV5	\$98
32-19	\$91
214B-FB	\$77
ARX-2B	\$37
A144-11	\$46

BC 350	\$375.00
BC 300	\$339.00
BC 20/20	\$279.00
BC 210XL	\$219.00
BC 200	\$169.00
BC 180	\$159.00
BC 260	\$249.00
BC 100	\$279.00
BC WA	\$34.95
*CP2100	\$279.00
ALL SOFTWARE	\$39.95

### KLM

KT34A	\$329
KT34XA	\$479
40M-2	\$290
2M-13LBA	\$77
2M-14C	\$85
435-18C	\$59
432-16LB	\$65

LARSEN CALL

**NEW**

HUSTLER CALL

### BUTTERNUT

### AEA

### CALL

HF6V \$109

Call "TOLL FREE" For All Antennas & Accessories



2900 N.W. VIVION RD. / KANSAS CITY, MISSOURI 64150 / 816-741-8118

## Your Ham Tube Headquarters!

TUBES BOUGHT, SOLD AND TRADED  
SAVE \$\$\$—HIGH \$\$\$ FOR YOUR TUBES

Call Toll Free 800-221-0860

### Tubes

3-400Z	\$85.00	7360	\$10.00
3-500Z	85.00	7735A	27.50
4-400A	80.00	8122	105.00
4CX250B	50.00	8156	12.50
572B	48.50	8643	82.50
811A	12.00	8844	26.50
813	30.00	8873	175.00
6146B	6.50	8874	185.00
6360	4.25	8877	500.00
6883B	6.75	8908	12.50

### MAJOR BRANDS ON RECEIVER TUBES 75% off list

#### Semiconductors

MRF 245/SD1416	\$30.00	MRF 644/SD1088	19.95
MRF 454	14.95	2N3055	75¢
MRF 455	10.95	2N6084	12.50

#### RF Connectors

PL259	10/\$4.95	M358	2.50 ea.
PL258	10/8.95	M359	1.75 ea.
UG 175/176	10/1.60	Type "N" Twist on	
UG255/u	2.50 ea.	(RG8/u)	\$4.75 ea.
UG273/u	2.25 ea.	Minimum Order	\$25.00

Allow \$3.00 min. for UPS charges

**CeCo**

COMMUNICATIONS, Inc.  
2115 Avenue X Brooklyn, NY 11235

Phone (212) 646-6300

SERVING THE INDUSTRY SINCE 1922  
Call CECo For Your CCTV Security And Color Production Requirements

## STUMPED FOR A GIFT IDEA?

### I.D. BADGES

No ham should be without an I.D. badge. It's just the thing for club meetings, conventions, and get-togethers, and you have a wide choice of colors. Have your name and call engraved in either standard or script type on one of these plastic laminated I.D. badges. Wear it with pride!

Available in the following color combinations (badge/lettering): white/red, woodgrain/white, blue/white, white/black, yellow/blue, red/white, green/white, metallic gold/black, metallic silver/black.



### HERE'S A GIFT IDEA!

How about an attractive BASEBALL style cap that has name and call on it. It's the perfect way to keep eyes shaded during Field Day, it gives a jaunty air when worn at Hamfests and it is a great help for friends who have never met to spot names and calls for easy recognition. Great for birthdays, anniversaries, special days, whatever occasion you want it to be. Hats come in the following colors: GOLD, BLUE, RED, KELLY GREEN. Please send call and name (maximum 6 letters per line).

UFBC-81

\$5.00

REGULAR PRICE HAT AND BADGE \$7.50 + SHIPPING

**SPECIAL \$6.49**  
**SAVE \$1.00**

Please enclose \$1 to cover shipping and handling.

**HAM RADIO'S BOOKSTORE**  
GREENVILLE, NH 03048  
(603) 878-1441



**BUTTERNUT  
ELECTRONICS  
COMPANY**



Model 2MCV "Trombone" Model HF6V Model 2MCV-5 "Super Trombone"

**THE  
WINNERS**

Model HF6V—Completely automatic bandswitching 80 through 10 plus 30 meters. Outperforms all 4- and 5-band "trap" verticals of comparable size. Thousands in use worldwide since December, B1! 160 meter option available now, retrofit kits for remaining WARC bands coming soon. Height: 26 ft/7.8 meters, guying not required in most installations.

Model 2MCV "Trombone"—omnidirectional collinear gain vertical for 2 meters having the same gain as "double-A" types, but the patented "trombone" phasing section allows the radiator to remain unbroken by insulators for maximum strength in high winds. No coils "plumber's delight" construction and adjustable gamma match for complete D.C. grounding and lowest possible SWR. Height: 9.8 ft/2.98 meters.

Model 2MCV-5 "Super-Trombone"—Same advanced features as the basic 2MCV but a full wavelength taller with additional "Trombone" phasing section for additional gain. Height: 15.75 ft/4.8 meters.

All BUTTERNUT ANTENNAS use stainless steel hardware and are guaranteed for a full year. For further information on these and other BUTTERNUT products write for our FREE CATALOG!

**BUTTERNUT  
ELECTRONICS**  
405 E. MARKET STREET  
LOCKHART, TX 78644

# Build a "Supershack"

From QRP to SSB, Heath leads the way with high tech products that perform.

**NEW**



SS-9000



HW-9



HD-8999



HW-5400



HL-2200

- **HW-9** Deluxe QRP CW Transceiver covers CW in 80, 40, 20 and 15 meters, expandable to 30, 17, 12 and 10 meter bands.
- **SS-9000** microprocessor-based, solid-state Deluxe HF Transceiver with nine band operation.
- **HD-8999 UltraPro™** CW micro-controlled keyboard. Send letter perfect code at up to 99 WPM.
- **HW-5400** Synthesized HF SSB/CW Transceiver. Our lowest cost, high tech transceiver.
- **HL-2200** 2kW Linear Amplifier. The lowest cost-per-watt in 2k linears.
- **Plus dozens** of other high tech amateur products and accessories.

See our complete amateur radio line including the new Tunable Active Audio Filter, RTTY Terminal Interface, Smart Outlet Box and more.

Over 50 value-priced products for the well-equipped hamshack. See them on display at a nearby Heathkit Electronic Center!



Get more information in the **FREE CATALOG**

Please send me the new, expanded 104-page Heathkit Catalog.

Mail to: Heath Company, Dept. 122-202  
Benton Harbor, MI 49022

Name \_\_\_\_\_

Address \_\_\_\_\_

City \_\_\_\_\_

State \_\_\_\_\_ Zip \_\_\_\_\_

AM-439R1

**Heathkit**  
Heath  
Company

# ANTENNA/TOWER SALE!

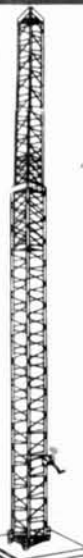

## hy-gain CRANKUP SALE!

All Models Shipped Factory Direct—Freight Paid\*!

- Check these features:
- All steel construction
  - Hot dip galvanized after fabrication
  - Complete with base and rotor plate
  - Totally self-supporting—no guys needed

Model	Height	Load	Sale Price
HG37SS	37 ft.	9 sq. ft.	\$ 719
HG52SS	52 ft.	9 sq. ft.	\$1049
HG54HD	54 ft.	16 sq. ft.	\$1629
HG70HD	70 ft.	16 sq. ft.	\$2599

Masts—Thrust Bearings—Other Accessories Available—Call! Prices Shown Are Your Total Delivered Price In Continental U.S.A.!



**RG-213U** \$ 29/ft \$279/1000 ft  
Up to 600 ft via UPS

- RG-213/U—95% Bare Copper Shield
- Mil-Spec Non-contaminating Jacket for longer life than RG8 cables.
- Our RG-213/U uses virgin materials.
- Guaranteed Highest Quality!



**RG-8X** \$ 19/ft \$179/1000 ft

- RG8X—95% Bare Copper Shield • Low Loss
- Non-contaminating Vinyl Jacket • Foam Dielectric

**Coaxial Cable Loss Characteristics (DB/100 ft)**

Cable Type	Imped	10MHz	30MHz	150MHz	450MHz
RG-213/U	50	.6	.9	2.3	5.2
RG8X	52	.8	1.2	3.5	6.8
RG-58/U	52	1.4	1.9	6.0	12.5
1/2" Alum	50	.3	.5	1.2	2.2
1/2" Helix	50	.2	.4	.9	1.6
1/4" Helix	50	.1	.2	.5	.9



**HARDLINE/HELIX™**

Lowest Loss for VHF/UHF!

- 1/2" Alum, w/poly Jacket \$ 79/ft
- 1/2" LDF4-50 Andrew Helix™ \$1.69/ft
- 1/4" LDF5-50 Andrew Helix™ \$3.99/ft

select connectors below.

**HARDLINE & HELIX™ CONNECTORS**

Cable Type	UHF FML™	UHF MALE	N FML	N MALE
1/2" Alum	\$19	\$19	\$19	\$25
1/2" Helix™	\$22	\$22	\$22	\$22
1/4" Helix™	\$49	\$49	\$49	\$49

**AMPHENOL CONNECTORS**

- Silver PL259 \$1.25 UG23D N Female \$2.95
- UG21B N Male \$2.95

**ANTENNA WIRE & ACCESSORIES**

- 14 Ga. Stranded Copperweld \$ 10/ft
- 450 Ohm H. D. Line \$ 16/ft
- 18 Ga. Copperweld 1/4mi. \$30
- H. D. End Insulators \$2/ea
- Van Gorden 1:1 Balun \$11
- Van Gorden Center Insulator \$6

**HUSTLER** 6BTV 80-10 mtr Vert \$129  
4B1V 40-10 mtr Vert \$89 5BTV 80-10 mtr Vert \$109  
G6-144B 2-mtr Base \$89 G7-144 2-mtr Base \$119

**Mobile Resonators**

10m	15m	20m	40m	75m
400W Standard	\$12	\$12	\$15	\$18
2KW Super	\$18	\$20	\$22	\$26

Bumper Mounts - Springs - Folding Masts in Stock!

## ROHN Self Supporting Towers On SALE!

### FREIGHT PREPAID

- All Steel Construction—Rugged
- Galvanized Finish—Long Life
- Totally Free Standing—No Guy Wires
- America's Best Tower Buy—Compare Save \$
- Complete With Base and Rotor Plate
- In Stock Now—Fast Delivery

Model	Height	Ant. Load*	Weight	Delivered Price*
HBX40	40 ft	10 sq ft	164	\$319
HBX48	48 ft	10 sq ft	303	\$399
HBX56	56 ft	10 sq ft	385	\$489
HDX40	40 ft	18 sq ft	281	\$379
HDX48	48 ft	18 sq ft	363	\$469

\*Your Total Delivered Price Anywhere in Continental 48 States. Antenna Load Based on 70 MPH Wind.

**CUSHCRAFT MULTI-BAND HF ANTENNAS**

A3 3-el Tribander \$219 A4 4-el Tribander \$289  
R3 20/15/10mtr Vert \$279 A743/A744 40mtr Kit \$75

**HF MONO-BAND ANTENNAS**

Model	Price
10-3CD	\$ 95
15-3CD	\$119
20-3CD	\$199
40-2CD	\$289

**VHF/UHF BEAMS**

Model	Price
A50-5	\$ 79
214B	\$ 79
220B	\$ 95

**OSCAR/TWIST ANTENNAS**

Model	Price
A144-10T	\$ 52
A147-20T	\$ 75
A147-20F	\$ 63
A14TMB	\$ 29

**VHF/UHF FM ANTENNAS**

Model	Price
A147-4	\$ 29
214FB	\$ 79
A449-6	\$ 29

## HY-GAIN

**Discoverer 2-el 40-mtr Beam** \$319  
**Discoverer 3-el Conversion Kit** \$199

Explorer-14 \$309  
QK710 30/40 mtr. Add-On-Kit \$79  
V2S 2-mtr Base Vertical \$49  
TH5MK2S Broad Band 5-el Triband Beam \$389  
TH7DXS 7-el Triband Beam \$439  
TH3JRS 3-el Triband Beam \$189  
TH2MK3S 2-el Triband Beam \$179  
205BAS 5-el 20-mtr Beam \$349  
155BAS 5-el 15-mtr Beam \$199  
105BAS 5-el 10-mtr Beam \$129  
204BAS 4-el 20-mtr Beam \$259  
64BS 4-el 6-mtr Beam \$69  
66BS 6-el 6-mtr Beam \$135  
18HTS 80-10 mtr Hy-Tower Vertical \$439  
LC-160 160-mtr Coil Kit for 18HTS \$45  
214BS 14-el 2-mtr Beam \$49  
28DQ 80/40 mtr Trap Dipole \$69  
58DQ 80-10 mtr Trap Dipole \$129  
BN86 80-10 mtr KW Balun W/Coax Seal \$22

**MOSLEY**

Model	Price
Pro37 7-el Triband Beam	\$469
CL-33 e-el Triband Beam	\$279
TA-33 3-el Triband Beam	\$249
TA-33JR 3-el Triband Beam	\$189
TA40KR 40 mtr Kit for TA33	\$119



These rugged crankup towers now available from Texas Towers! All models available On Sale for tremendous savings to you!

To save on freight costs, all towers are shipped directly from the Tri-Ex factory to you!

Check these features:

- All steel construction
- Hot dip galvanized after fabrication
- Complete with base and rotor plate
- Totally self-supporting—no guys needed

Model	Height Up	Down	Wind Load	List	Sale
W36	36.0 ft	20.5 ft	9.0 sq ft	\$694	\$579
WT51	51.0 ft	20.5 ft	9.0 sq ft	\$1154	\$999
LM354	54.0 ft	21.0 ft	16 sq ft	\$2010	\$1599
LM470D	70.0 ft	22.0 ft	16 sq ft	\$4195	\$2999
(Motorized) DX86	86.0 ft	23.0 ft	25 sq ft	\$7200	Call
(Motorized)					

**MINI-PRODUCTS HQ-1**  
LIST \$182.50 SALE \$159

- Wing Span - 11 ft
- Wind Area - 1.5 sq ft
- Boom - 54 in. long
- 1200W P.E.P. Input

## ALPHA DELTA COMMUNICATIONS

Transit-Trap™ Surge Protectors—In Stock Now!

Model LT 200W UHF Type \$19  
Model HT 2KW UHF Type \$29  
Model LT/N 200W N Type \$39  
Model HT/N 2KW N Type \$44  
Model R-T 200W Deluxe \$29  
Model HV 2KW Deluxe \$32

## KLM

KT34A 4-el Broad Band Triband Beam \$339  
KT34XA 6-el Broad Band Triband Beam \$489  
80m-1 80-mtr Rotatable Dipole \$469  
40m-1 40-mtr Rotatable Dipole \$179  
40m-2 2-el 40-mtr Beam \$309  
40m-3 3-el 40-mtr Beam \$439  
40m-4 4-el 40-mtr Beam \$649  
20m-6 6-el 20-mtr Beam \$689  
15m-6 6-el 15-mtr Beam \$439  
10m-6 6-el 10-mtr Beam \$259  
10-30-7LPA Log Periodic Beam \$639  
2m-13LBA 13-el 2-mtr Beam \$79  
2m-14C 14-el 2-mtr Satellite Antenna \$89  
435-18C 435 MHz Satellite Antenna \$65  
432-16LB 16-el 432 MHz Beam \$69

## ROTORS & CABLES

Alliance HD73 (10.7 sq ft rating) \$109  
Alliance U110 (3 sq ft rating) \$49  
Telex HAM 4 (15 sq ft rating) \$219  
Telex Tailwister (20 sq ft rating) \$269  
Telex HDR300 Heavy Duty (25 sq ft rating) \$519  
Kenpro KR-500 Heavy duty elevation rotor \$189.00  
Standard 8 cond cable \$ 19/ft (vinyl jacket 2-#18 & 6-#22 ga)  
Heavy Duty 8 Cond cable \$36/ft (vinyl jacket 2-#16 & 6-#18 ga)

## SOUTH RIVER ROOF TRIPODS

HDT-3 3 ft Tripod \$19 HDT-5 5 ft Tripod \$29  
HDT-10 10 ft Tripod \$49 HDT-15 15 ft Tripod \$69  
Heavy Duty Tripods include mtg hdw—UPS Shippable



Designed to operate on all Amateur Bands at "FULL" Legal Power Input.

- Automatic Band Switching (80/10 meters)
- Automatic Band Switching (160/10 meters) with optional model TBR-160 HD.
- IN STOCK for IMMEDIATE DELIVERY & LOOK at very SPECIAL PRICES
- New Model HF6V \$129.00
- New Model TBR-160HD (High Power 160 meter Base Resonator) \$49.00.
- Model RMK-11 (roof mount kit with multiband radial kit \$39.00.
- Model STR-2 (Stub Tuned Radial Kit) \$29.00.

Delivery Anywhere In The Continental USA At No Additional Cost. (Free Shipping On Butternut Accessories Also When Purchased With Antenna.)

## ROHN GUYED TOWERS

10 ft Stack Sections

20G \$37.50 25G \$46.50  
45G \$107.50 55G \$127.50

All 20G, 25G, 45G and 55G Accessories In Stock at Discount Prices - CALL!

**Foldover Towers**

Model	Height	Ant Load*	Price
FK2548	48 ft	15.4 sq ft	\$ 829
FK2558	58 ft	13.3 sq ft	\$ 899
FK2568	68 ft	11.7 sq ft	\$ 959
FK4544	44 ft	34.8 sq ft	\$1159
FK4554	54 ft	29.1 sq ft	\$1259
FK4564	64 ft	28.4 sq ft	\$1359

25G Foldover Double Guy Kit \$199  
45G Foldover Double Guy Kit \$229  
\*Above antenna loads for 70 MPH winds and Guys at Hinge & Apex.

## TOWER/GUY HARDWARE

3/16" EHS Guywire (3990 lb rating) \$ 13/ft  
1/4" EHS Guywire (6000 lb rating) \$ 16/ft  
5/32" 7 x 7 Aircraft Cable (2700 lb rating) \$ 12/ft  
3/16" CCM Cable Clamp (3/16" or 5/32" Cable) \$ .35  
1/4" CCM Cable Clamp (1/4" Cable) \$ .45  
1/4" TH Thimble (fits all sizes) \$ .30  
3/8" EE (3/8" Eye & Eye Turnbuckle) \$5.95  
3/8" EJ (3/8" Eye & Jaw Turnbuckle) \$6.95  
1/2" EE (1/2" Eye & Eye Turnbuckle) \$8.95  
1/2" EJ (1/2" Eye & Jaw Turnbuckle) \$9.95  
3/16" Preformed Guy Grip \$1.99  
1/4" Preformed Guy Grip \$2.49  
6" Diam - 4 ft Long Earth Screw Anchor \$12.95  
500D Guy Insulator (5/32" or 3/16" Cable) \$1.39  
502 Guy Insulator (1/4" Cable) \$2.49  
5/8" Diam - 8 ft Copper Clad Ground Rod \$12.95

## PHILLYSTRAN GUY CABLE

HPTG2100 Guy Cable (2100 lb rating) \$ 29/ft  
HPTG4000 Guy Cable (4000 lb rating) \$ 43/ft  
HPTG6700 Guy Cable (6700 lb rating) \$ 69/ft  
9901LD Cable End (for 2100/4000 cable) \$6.95  
9902LD Cable End (for 6700 cable) \$7.95  
Socketfast Potting Compound (does 6-8 ends) \$12.95

## GALVANIZED STEEL MASTS

Heavy Duty Steel Masts 2 in OD - Galvanized Finish

Length	5 FT	10 FT	15 FT	20 FT
.12 in Wall	\$25	\$39	\$59	\$79
.18 in Wall	\$39	\$69	\$99	\$109
.25 in Wall	\$69	\$129	\$189	\$249

# TEXAS TOWERS

Telephone (214) 422-7306

Div. of Texas RF Distributors Inc.  
1108 Summit Ave., Suite 4 • Plano, Texas 75074

Store Hours: Mon-Fri: 9am - 5pm  
Sat: 9am - 1pm



# COMMUNICATIONS EQUIPMENT SALE!

**ICOM**



**ICOM IC-751A LIST PRICE \$1399  
CALL FOR SPECIAL SALE PRICE!**



**ICOM IC-745 LIST PRICE \$999  
CALL FOR SPECIAL SALE PRICE!**

**IC-02AT  
NEW 2 METER  
TOP OF THE LINE HT**

- Digital LCD Readout
- Scanning
- Programmable PL Tones
- Optional 5W Battery
- S-meter Function
- 10 Memories
- Offset Storage
- Lithium Memory Backup
- 13.8VDC Operation!
- Sealed Case

**SUGGESTED LIST PRICE \$349  
CALL FOR SALE PRICES!**

**KENWOOD**



**TS-930S LIST PRICE \$1799  
CALL FOR SPECIAL SALE PRICE!**



**TS-430S LIST PRICE \$899.95  
CALL FOR SPECIAL SALE PRICE!**

**TR-2500 2.5W/300 mW  
(Switchable) 2 Meter  
Handheld Transceiver**

**Small Size— Small Price—  
Big Performance!**

- LCD Readout
- Ten Memories
- Lithium Back-up
- Band and Memory Scan
- Built-in Sub-tone Encoder
- Built-in 16 Key
- Autopatch Encoder
- Slide Lock Battery Pack

**TR-2500 List Price \$329.95  
CALL FOR SPECIAL SALE PRICES**

**FT**



**FT-757GX LIST PRICE \$829  
CALL FOR SPECIAL SALE PRICE!**



**FT-726R LIST PRICE \$829  
CALL FOR SPECIAL SALE PRICE!**

**FT-208R 2M HT  
List \$319**

**FT-708R 440 MHz HT  
List \$319**

- LCD Display
- 10 Memories

**CALL FOR SPECIAL PRICES!**

**SANTEC**

**NEW ST142μP  
2M HT**

- 3.5W/1W/0.1W
- 142-149.995 MHz
- LCD Display
- Programmable PL Option

**List 339.95  
SALE \$299.95!**



ST144μP ..... \$259.95  
ST222μP ..... CALL!  
ST442μP ..... CALL!

**SANTEC Accessories**

- SM3 Speaker Mic. .... \$34.95
- ST-LC Leather Case .... \$34.95
- ST-500 NiCad Battery .. \$29.95
- ST-4QC Base Charger .. \$69.95

**FACTORY AUTHORIZED DEALER FOR ALL MAJOR AMATEUR LINES**

**ETD ALPHA SALE!**



**76PA \$1899!**

Model	List	Sale*
76A	\$1985	CALL
76PA	\$2395	CALL
76CA	\$2695	CALL
374A	\$2595	CALL
78	\$3495	CALL

\*Sale Prices Too Low To Print—  
CALL & SAVE \$\$!

**TEN-TEC  
SALE!**



**CORSAIR List \$1169  
Deluxe AC Supply List \$199  
Both Items—Yours for \$1169!  
All Ten-Tec Accessories in Stock  
for Fast Shipment!**

**TEN-TEC  
New 2M HT  
Full Featured!  
List \$319  
Sale \$279.95!**

**4229 2KW Tuner Kit \$189.95!**

**HAL SALE!  
NEW RTTY/CW COMPUTER  
INTERFACES**



**CRI-100 List \$249 SALE \$229.95!  
CRI-200 List \$299 SALE \$269.95!**

**CWR6850  
RTTY/CW  
TERMINAL**

**List \$999 SALE \$749.95!**

**Other HAL Products On Sale**

CWR6700	\$439.95	DS3100ASR	\$1699.95
CWR6750	\$629.95	MPT3100	\$2199.95
CT2100/KB2100	\$749.95	RS2100	\$289.95
CT2200/KB2100	\$949.95	ST5000	\$219.95
DSK3100	\$1049.95	ST6000	\$649.95
ARQ1000	\$649.95	KG-12	\$169.95

**TOKYO  
HY-POWER LABS**

**HL-30V Reg. \$69.95  
SALE \$59.95**

HL-82V .. \$139.95 HL-90U .. \$329.95  
HL-160V .. \$289.95 HC-200 .. \$89.95  
HL-20U .. \$99.95 HC-2000 .. \$289.95

**KDK FM2033  
List \$339.95 Sale \$299.95**



**Kantronics**

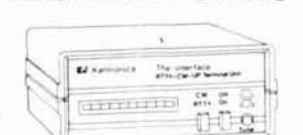

**The Interface Reg. \$169.95 Sale \$129.95  
The Interface II Reg. \$269.95 Sale \$239.95**

**Apple Amtr**

Soft/Hamtext...\$139 VIC-20 Hamsoft .....49  
VIC-20 Amtr Soft..89 Hamtext VIC-20.....99  
**Model 64** Hamtext Model-64..99  
Amtr Soft.....89 Atari Hamsoft.....49  
**Apple Hamsoft.....29 TRS-80C Hamsoft.....59**

**MIRAGE AMPLIFIER  
SALE!**



**B1016  
\$249**

Model	Band	Pre-amp	Input	Output	DC Pwr	Sale Price
A1015	6M	Yes	10W	150W	20A	\$249
B23	2M	No	2W	30W	5A	\$ 79
B215	2M	Yes	2W	150W	22A	\$259
B108	2M	Yes	10W	80W	10A	\$159
B1016	2M	Yes	10W	160W	20A	\$249
B3016	2M	Yes	30W	160W	17A	\$199
C22	220	No	2W	20W	5A	\$ 79
C106	220	Yes	10W	60W	10A	\$179
C1012	220	Yes	10W	120W	20A	\$259
D24	440	No	2W	40W	8A	\$179
D1010N	440	No	10W	100W	20A	\$289

RC-1 Remote Control for Mirage Amplifiers \$24  
MP-1 and MP-2 Peak Reading Wattmeter \$99

**ASTRON POWER SUPPLIES**

**Heavy Duty - High Quality - Rugged - Reliable**

- Input Voltage 105-125 VAC. Output 13.8VDC ± 05V
- Fully Electronically Regulated—5mV Maximum Ripple
- Current Limiting & Crowbar Protection Circuits
- M-Series With Meter—A-Series Without Meter

Model	Cont Amps	ICS Amps	Price
RS4A	3	4	\$ 39
RS7A	5	7	49
RS12A	9	12	69
RS20A	16	20	89
RS20M	16	20	109
RS35A	25	35	135
RS35M	25	35	149
RS50A	37	50	199
RS50M	37	50	229



**CP-1 COMPUTER PATCH  
List \$239.95 SALE \$189.95!**

CP1-20 .....\$219 CP1-64 .....\$219  
MP-20 .....\$129 MP-64 .....\$129  
VIC-20 MBA Text \$79 C-64 MBA Text .....\$79

**All AEA Keyers, Antennas & Accessories  
In Stock!**

**MFJ 1224 COMPUTER INTERFACE \$89.95**

202B Noise Bridge ..... \$59.95  
250 2KW Oil Load ..... \$35.95  
422 Keyer/Paddle ..... \$89.95  
901 300W Tuner ..... \$59.95  
941C 300 W Tuner ..... \$89.95  
989 Deluxe 2KW ..... \$299.95

**METRON  
MA1000B  
AMPLIFIER**

**Solid State  
1KW Amplifier**

- No Tuning
- 13.8 VDC Operation
- Remote Bandswitching
- Compact
- Heavy-Duty Construction

**List Price \$995 SALE PRICE \$895.95**

**TEXAS TOWERS**

**Telephone  
(214) 422-7306**

Div. of Texas RF Distributors Inc. 1108 Summit Ave., Suite 4 • Plano, Texas 75074

Monday-Friday 9 AM - 5 PM Saturday 9 AM - 1 PM





# NEW BOOKS



## ham radio magazine BOOKSTORE



PRICE SLASHED!

WAS \$39.95 retail  
**NOW \$19.95**

**RADIO HANDBOOK**  
by Bill Orr, W6SAI

The 22nd edition reflects the very latest in state-of-the-art techniques. Over 1,000 pages of information found in earlier editions plus more on antennas, amplifiers, theory, and semiconductors. The **Radio Handbook** is chock-full of practical, tested projects that run from high powered RF amplifiers and state-of-the-art equipment to "Weekender" type projects to upgrade overall station performance. At this special price, you can't afford to pass up a value like this. Order yours today. 1136 pages. ©1981. 22nd edition.

21874 **Hardbound** **\$19.95**

This is the very latest edition. No new edition is about to be issued. This is not a close out. Quantities Limited.

### RADIO COMMUNICATIONS RECEIVERS

by Cornell Drentea, WB3JZO

Complete and detailed history of receivers covering the coherer, the decohorer, Galena crystals, audio and regenerative designs and the tuned frequency receiver. It also includes single, multiple and direct conversions of the superheterodyne design. You get helpful hints and tips on how to solve image problems, selectivity, crystal filters, mechanical and ceramic filters and much, much more. System design, J-fets and synthesizers — it's all here in one complete volume. ©1982. 1st edition.

T-1393 **Softbound \$13.95**

### RF CIRCUIT DESIGN

by Chris Bowick, WB4UHY

This book has been written for those who desire a practical approach to the design of rf amplifiers, impedance measuring devices and filters. Plenty of projects and design ideas. 7 chapters cover from basics to advanced design concepts. You get a complete design run down for multiple pole Butterworth, Chebyshev and Bessel filters. RF Circuit Design also includes a bibliography of books and technical papers to help further your knowledge of circuit design. ©1983. 176 pages. 1st edition.

21868 **Softbound \$22.95**

## — SPECIAL PRICE —

### 1984 U.S. RADIO AMATEUR CALLBOOK

This is the latest edition of the grand daddy of all the others. The Callbook is the only directory with an in-house editorial department that checks the FCC info as it comes in to ensure accuracy. U.S. and foreign hams swear this is the most important reference book in their files. Order your copy today. Ensure you have the very latest QSL information available at your fingertips. Over 410,000 listings. Also contains helpful and hard-to-find operating and station aids. ©1983.

CB-US84 (\$16.95 + \$3 S & H) **Softbound \$19.95**

### 1984 FOREIGN RADIO AMATEUR CALLBOOK

The only foreign callbook available! DXCC is the goal of many hams. To others, casual rag chews with foreign hams are the real joy of Amateur Radio. Whatever your interest, if you want a QSL, you should have a copy of the latest Foreign Callbook in your shack. Fully up-dated with the latest lists direct from the overseas licensing authorities. ©1983.

CB-F84 (\$15.95 + \$3 S & H) **Softbound \$18.95**

## BUY BOTH CALLBOOKS SAVE

CB-USF **\$32.90**

Includes shipping U.S.A.

Callbooks shipped postpaid. Shipping & handling for ARRL Repeater Directory and AMECO 12-01, \$1.50. All other books \$2.50.

### 1984 38th EDITION WORLD RADIO AND TV HANDBOOK

The brand new 1984 edition is jam-packed with station addresses, frequencies, schedules and all the other information needed to get the most enjoyment out of SWL'ing. Also includes latest equipment reviews, handy hints and tips on how to improve reception and much more. It's the only complete reference guide to international broadcasting available today. ©1984.

WR-TV **Softbound \$17.50**

### RTTY TODAY

A Modern Guide to Amateur Radio Teletype

by Dave Ingram, K4TWJ

Brand New and Fully up-to-date. Dave Ingram's clear, concise writing style and a wealth of illustrations, diagrams and photos, make RTTY as easy as 1-2-3! Extensive coverage is given to using home computers for RTTY. Eleven chapters start with an overview of RTTY operation, then give you coverage of operating parameters, computers, equipment you can build, dedicated systems and four chapters on RTTY SWL'ing info. 135 pages. ©1984. 1st edition.

UE-AR **Softbound \$8.95**

### THE SATELLITE EXPERIMENTER'S HANDBOOK

In 1961, a new era was begun in Amateur Radio with the launch of the first Orbiting Satellite Carrying Amateur Radio, OSCAR. Since then, thousands of electronic hobbyists, around the world, have used OSCARs for communication, experimentation and for educational purposes. This new League publication also carries information on Weather and TV Satellites. Subjects include information on satellites in orbit and satellite design as well as how to build a ground station and antennas. ©1984. 1st edition.

AR-SE **Softbound \$10.00**

### 1984-85 ARRL REPEATER DIRECTORY

You could call this book the "repeater bible". Close to 8,000 listings include stations organized first by frequency then by state and region. All of the important details such as access tones, auto patch, etc. are also included. If you do any traveling and take a two-meter rig with you, this is the book to have! ©1984.

AR-RD **Softbound \$2.00**

### GENERAL-CLASS RADIO AMATEUR FCC TEST MANUAL

Here is the first General-class study guide keyed to both the Volunteer and FCC administered exams. The 500 questions to be used for the Volunteer exam are fully covered with detailed, concise answers. You also get ten pages of study material taken from the currently administered FCC exam. As a bonus, all questions are keyed to Ameco's Theory Course, 102-01, for a more detailed explanation of the study material. If you have mastered this book, you'll be ready to pass either an FCC or Volunteer administered exam. ©1984. 1st edition.

12-01 **Softbound \$3.25**

### COMPUTER PROGRAMS FOR AMATEUR RADIO

by Wayne Overbeck, N6NB, and James Steffen, KC6A

Here's a great source book of computer programs for the Radio Amateur. Besides covering the basic computer programs like Morse code generator, logging and general data processing, the authors show you how to speed up math calculations, determine sunrise-sunset times for any location on earth, set up a record system for DXCC, WAS, VUCC, or any other award, track the moon's path for EME work and much more. Programs included are written for most popular computers. Take full advantage of your computer's capabilities with this well written, easy-to-use resource book. ©1984. 1st edition.

HA-0657 **\$16.95**

### THE COMPLETE DX'ER

by Bob Locher, W9KNI

DX'ing can be as simple as turning the radio on and searching across a band, or it can be hours spent studying propagation reports, sunspot figures and the DX newsletters looking for tidbits of information. The first part of the book is designed to teach the reader DX'ing fundamentals. Part two is for the "over 200 countries worked" operator and has plenty of handy tips, aids and ideas. Part 3 is full of more esoteric hints for the "over 300 countries worked" operator. This book tells all and should be required reading before anyone starts their quest for DXCC. Even if you don't care about DXCC, Bob's easy-to-read style of writing is most enjoyable reading. ©1984. 1st edition.

ID-DX **Softbound \$10.95**

### THE DX EDGE

This handy DX operating aid should be in every ham's shack! Twelve different month overlays are included to show the sun's path over the earth. To use the DX Edge, you simply align the hour printed on the top of the overlay with your local time. You instantly see the sun's relative position around the earth. Great for determining possible gray line and long path openings. Plastic slide rule format and large size make the DX Edge very easy-to-use.

XN-DX **\$16.95**

### THE TAB HANDBOOK OF RADIO COMMUNICATIONS

by Joe Carr, K4IPV

Starting with an overview of the basic building blocks of physical science, Joe Carr gives the reader a complete self-contained study course in basic electricity and electronics. Besides being an excellent electronics reference book, it's also an ideal study guide for both Amateur and commercial license exams. All aspects of radio are covered: receivers, transmitters, operating modes, radio-wave propagation, transmission lines, antennas, and more. Of importance to beginners, Joe Carr also covers in detail the fundamentals of radio repair and troubleshooting. ©1984. 1st edition.

T-1636 **Softbound \$29.50**

### THE AMATEUR RADIO VERTICAL HANDBOOK

by Cpt. Paul H. Lee, USN (Ret.), N6PL

This brand new, second edition of the **only** book dedicated to the vertical antenna, will be of interest to all those using or looking to use the vertical antenna. Based upon the author's years of work with a number of different vertical antenna designs, you'll get plenty of theory and design information along with a number of practical construction ideas. Included are designs for simple 1/4 and 5/8-wave antennas as well as broadband and multi-element directional antennas. Paul Lee is an engineer and avid ham and is Amateur Radio's resident expert on the vertical antenna. ©1984. 2nd edition.

CQ-VAH **Softbound \$9.95**

### SYNCHRONOUS PACKET RADIO USING THE SOFTWARE APPROACH

Vol. 2 AX.25 Protocol  
by Bob Richardson, W4UCH

There are two basic ways to get into packet radio. The first is the hardware approach and requires a sophisticated "black box." The second way is to use machine language programs that are specially designed for packet radio. W4UCH, author of **The Gumplexer Cookbook**, will help you in getting your Model I or III TRS-80 Radio Shack computer on packet radio. Twelve chapters take you step by step through the process of getting your computer to first convert the digital information into a usable format and then to decode the information. You also get six appendices that can be used as a handy reference guide as you improve your computer skills. ©1983. 1st edition.

RE-AX **Softbound \$21.95**

# ham radio magazine BOOKSTORE

GREENVILLE, NH 03048 (603) 878-1441

# High Performance vhf/uhf preamps

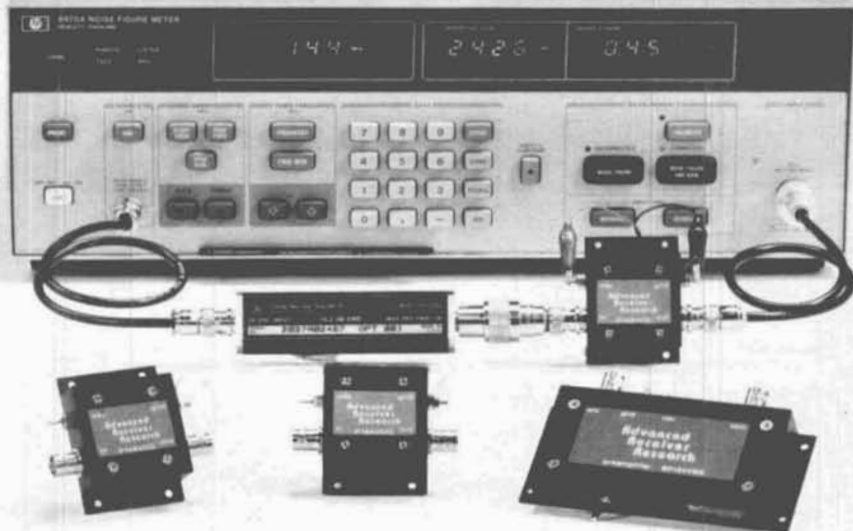

Receive Only	Freq. Range (MHz)	N.F. (dB)	Gain (dB)	1 dB Comp. (dBm)	Device Type	Price
P28VD	28-30	<1.1	15	0	DGFET	\$29.95
P50VD	50-54	<1.3	15	0	DGFET	\$29.95
P50VDG	50-54	<0.5	24	+12	GaAsFET	\$79.95
P144VD	144-148	<1.5	15	0	DGFET	\$29.95
P144VDA	144-148	<1.0	15	0	DGFET	\$37.95
P144VDG	144-148	<0.5	24	+12	GaAsFET	\$79.95
P220VD	220-225	<1.8	15	0	DGFET	\$29.95
P220VDA	220-225	<1.2	15	0	DGFET	\$37.95
P220VDG	220-225	<0.5	20	+12	GaAsFET	\$79.95
P432VD	420-450	<1.8	15	-20	Bipolar	\$32.95
P432VDA	420-450	<1.1	17	-20	Bipolar	\$49.95
P432VDG	420-450	<0.5	16	+12	GaAsFET	\$79.95

#### Inline (rf switched)

SP28VD	28-30	<1.2	15	0	DGFET	\$59.95
SP50VD	50-54	<1.4	15	0	DGFET	\$59.95
SP50VDG	50-54	<0.55	24	+12	GaAsFET	\$109.95
SP144VD	144-148	<1.6	15	0	DGFET	\$59.95
SP144VDA	144-148	<1.1	15	0	DGFET	\$67.95
SP144VDG	144-148	<0.55	24	+12	GaAsFET	\$109.95
SP220VD	220-225	<1.9	15	0	DGFET	\$59.95
SP220VDA	220-225	<1.3	15	0	DGFET	\$67.95
SP220VDG	220-225	<0.55	20	+12	GaAsFET	\$109.95
SP432VD	420-450	<1.9	15	-20	Bipolar	\$82.95
SP432VDA	420-450	<1.2	17	-20	Bipolar	\$79.95
SP432VDG	420-450	<0.55	16	+12	GaAsFET	\$109.95

Every preamplifier is precision aligned on ARR's Hewlett Packard HP8970A/HP346A state-of-the-art noise figure meter. RX only preamplifiers are for receive applications only. In-line preamplifiers are rf switched (for use with transceivers) and handle 25 watts transmitter power. Mount in-line preamplifiers between transceiver and power amplifier for high power applications. Other amateur, commercial and special preamplifiers available in the 1-1000 MHz range. Please include \$2 shipping in U.S. and Canada. Connecticut residents add 7-1/2% sales tax. C.O.D. orders add \$2. Air mail to foreign countries add 10%. Order your ARR Rx only or In-line preamplifier today and start hearing like never before!

## Advanced Receiver Research

Box 1242 • Burlington, CT 06013 • 203 582-9409



✓ 106

#### SEMICONDUCTORS:

MRF-208	12.00	MHW-252	53.00
MRF-240	18.40	MHW-710-1	61.00
MRF-247	34.80	MPSH-81	50
MRF-309	33.80	MV2205	58
MRF-422	41.40	78L08CP	50
MRF-454	20.00	2N4401	75
MRF-901	1.75	2N5190	1.50
SBL-1 Double-Balance Mixer	6.50		

#### P.C. BOARDS FOR MOTOROLA BULLETINS

AN-762	14.00	AN-791	10.00
EB-27A	14.00	EB-67	14.00
EB-63	14.00		
KEMET CHIP CAPACITORS: 56 pf, 82 pf,			
100 pf, 390 pf, 470 pf	50 ea.		
680 pf, 1000 pf	55 ea.		
5600 pf, 6800 pf, 1 µf	1.00 ea.		
33 µf	1.90 ea.	68 µf	3.90 ea.

CAMBION RF CHOKES: .15 µh, .22 µh, .33 µh, 4.7 µh, 10 µh .....1.20 ea.

BROADBAND TRANSFORMERS PER MOTOROLA BULLETINS: AN-762, EB-27A, EB-63 UNDERWOOD/SEMCO METAL-CLAD MICA CAPACITORS: 5pf, 10pf, 15pf, 25pf, 30pf, 40pf, 56pf, 60pf, 68pf, 80pf, 91pf, 100pf, 200pf, 250pf, 390pf, 470pf, 1000pf

We also carry a line of VHF, UHF amplifiers and ATV equipment. Call or write for our free catalog.

✓ 129



**CCI** Communication Concepts Inc.



2648 North Aragon Ave. • Dayton, Ohio 45420 • (513) 296-1411

IF YOU'RE STILL USING AN OLD STYLE ROTOR CONTROL MAYBE YOU SHOULD CONSIDER THIS...



BUY THE ANTENNA CONTROLLER OF THE FUTURE TODAY!

A PRO-SEARCH™

DIGITAL

ANTENNA CONTROL FULLY COMPUTERIZED

SMALL IN SIZE  
3 1/4" H x 5 7/8" W x 6" D

10 MEMORIES FOR STORING YOUR FAVORITE HEADINGS

ONE YEAR FULL WARRANTY

PRO-SEARCH Is Adaptable To Many Systems, Simple To Install.

No Modifications Are Necessary.

Presently we're having our Fall and Christmas Special. A PSE-1, used with the CDE Series. Now only \$315.00 plus shipping. Regular retail price \$419.91. Offer good until December 15, 1984. Order Early we expect a back order problem due to demand and availability of parts.

Also ask about our Fall Rotor, Antenna and Unit Special.

CALL NOW 1-800-325-4016

Controllers also available for other rotors.

Prices and specifications subject to change without notice or obligation.

U.S. and Foreign Patents

**PRO-SEARCH™** Reaching The World 

Pro-Search Electronics Co.

1344 Baur Boulevard St. Louis, Mo. 63132  
1-314-994-7872

✓ 175

August 1984 **hp** 75



# The Problem Solver...

The RF Wattmeter Model 81000-A from Coaxial Dynamics, Inc. does more than provide accurate rf measurements. Testing of transmission lines, antennas, connectors, filters and related components can reveal unknown problems and assure optimum equipment performance.

The 81000-AK Wattkit features this easy-to-read RF Wattmeter (pictured here), with its optional carrying case and an array of elements and accessories. Coaxial Dynamics elements can be purchased separately for use in other manufacturer's Wattmeters. For more information on the 81000-A Wattmeter or any of the complete line of Coaxial Dynamics RF products and OEM components please contact Coaxial Dynamics, Inc.

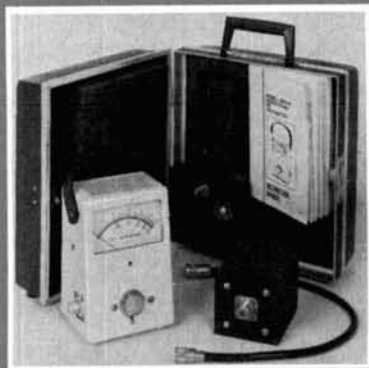

**COAXIAL DYNAMICS, INC.**

15210 Industrial Parkway, Cleveland, OH 44135 • (216) 267-2233  
Outside Ohio, WATS: (800) Coaxial, Telex: 980-630

✓ 128



## RTTY TODAY

MODERN GUIDE TO AMATEUR RADIOTELETYPE  
by Dave Ingram, K4TWJ

This brand new book is the only RTTY handbook available that covers all facets of RTTY operation from the "green key" generation to personal computers. Author Dave Ingram, K4TWJ, noted RTTY enthusiast, writes in a personable, easy-to-understand style that will appeal to all levels of RTTY interest. **RTTY TODAY** is fully illustrated with photos, diagrams, RTTY station set ups and equipment to help ensure full understanding of the material. 11 chapters cover: an overview of RTTY operation, operating parameters, home computers, equipment you can build, dedicated systems and complete chapters on RTTY SWLing with frequencies, codes and other helpful hints and tips. Old time RTTY users and novices alike will find this book extremely useful. ©1984. 95 illustrations. 1st edition. 8½ x 11.

Order yours today **\$895**  
plus \$1.75 shipping

**UNIVERSAL ELECTRONICS**

4555 Groves Rd. • Suite 3 • Columbus, OH 43232  
(614) 866-4605

Dealer Inquiries Invited

✓ 191

This Publication  
is available in  
Microform.



University Microfilms  
International

Please send additional information

for \_\_\_\_\_  
Name \_\_\_\_\_  
Institution \_\_\_\_\_  
Street \_\_\_\_\_  
City \_\_\_\_\_  
State \_\_\_\_\_ Zip \_\_\_\_\_

300 North Zeeb Road  
Dept. P.K.  
Ann Arbor, Mi. 48106

### Custom Mailing Lists on Labels! Amateur Radio Operator NAMES

Custom lists compiled to your specifications

- Geographic by ZIP and/or State
- By License Issue or Expiration Date
- On Labels of Your Choice

Total List: 435,000 Price: \$25/Thousand  
**Buckmaster Publishing** ✓ 123

Whitehall  
Mineral, VA 23117 U.S.A. (703) 894-5777



\$1295  
pr.

**HAM-TAGS**  
Amateur Radio  
standard for mobiles!

**HAM-TAGS** Your call on each vehicle. Call at top or bottom of frame, and frame front plate. No-nonsense, full refund, guarantee. \$1.50 shipping (First Class Mail). ✓ 120

BHC 1716 Woodland, Houston, TX 77019 (713) 522-5755

# fundamentals of grayline propagation

Signals don't  
always follow  
"normal" paths

**The decline of the sunspot cycle** has been accompanied by a corresponding decrease in DX opportunities on the higher frequency bands. Ten meters is becoming very sporadic in nature, as F-layer path openings continue to decrease in both number and duration. Within a few years, at the bottom of the solar cycle, the only activity remaining on 10 meters will be via sporadic-E propagation. The 15-meter band is not much better; as 10 meters goes downhill, so goes 15: this band will also continue to decline, offering fewer and poorer openings of much shorter duration.

As the levels of solar flux continue to drop, there will be an increasing number of days when the only (high HF band) activity will be found on 20 meters. Even this band won't offer the same quality openings of several years past. During many of the years to come, it will be a strictly daylight DX band with only scattered openings to various parts of the world.

With the knowledge that much of the DX has migrated to 40 and 80 meters, and believing that high power is required on these bands, many Amateurs feel that there's no place left for the "barefoot" DXer. After all, even though the low power operator can compensate for the lack of a kilowatt with a good beam and tower combination on the higher frequency bands, how many of us have the money and/or acreage for beams or phased arrays on 80 or 40 meters? Today, many low power operators will attempt to work DX on these bands only during contests, believing that their signals will never be heard at any other time.

## try grayline

Is there really no place left for the "barefoot" DXer? Of course not: nature has provided us with a mode of propagation on these low bands that will allow DX operation without the use of maximum power or costly low-band directive arrays. This type of propagation — called "grayline" or "shadow edge" propagation — takes place along that line dividing the daylight and darkness hemispheres of the planet, functions on both 80 and 40 meters, and offers outstanding conditions during all phases of the sunspot cycle. What's more, it's at its *best* during the years of low solar activity!

The line that divides the region of the Earth in daylight from the nighttime side is called the *terminator*. The terminator is not a distinct division, but instead a gray, "twilight" band approximately 1000 miles in width and stretching completely around the Earth. The time at any point along this band will be that of local sunrise or local sunset.

As shown in **fig. 1**, the position of the terminator changes as the position of the Earth changes with respect to the Sun. (This familiar phenomenon causes the change in seasons of the year and is due entirely to the tilt of the Earth's rotational axis. Since this axis is not perpendicular to the plane of the ecliptic, but rather tilted 23 degrees, 27 minutes, the terminator swings back and forth through an arc of just under 47 degrees during the course of a year. The northerly and southerly limits of this motion are delineated by the Antarctic and Arctic circles, respectively.)

The absorptive and refractive characteristics of the ionosphere are directly related to the angle of solar radiation. Normally, the higher this angle (the more nearly the Sun is to vertical), the more enhanced these characteristics become. Conversely, at very low angles of radiation, the absorption characteristics change much more quickly than do the refractive characteris-

By Bradley Wells, KR7L, 5053 37th Avenue,  
S.W., Seattle, Washington 98126

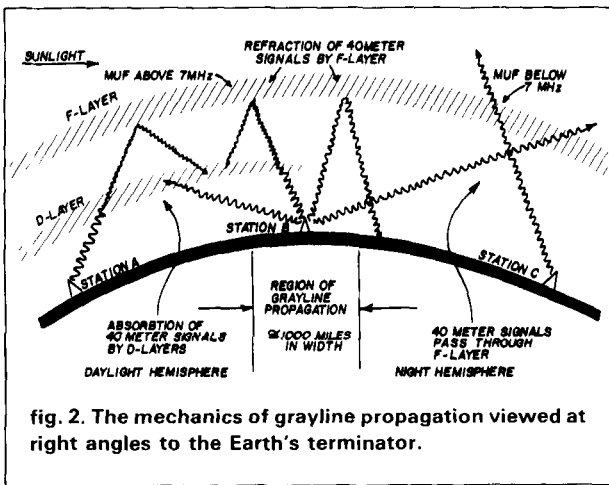
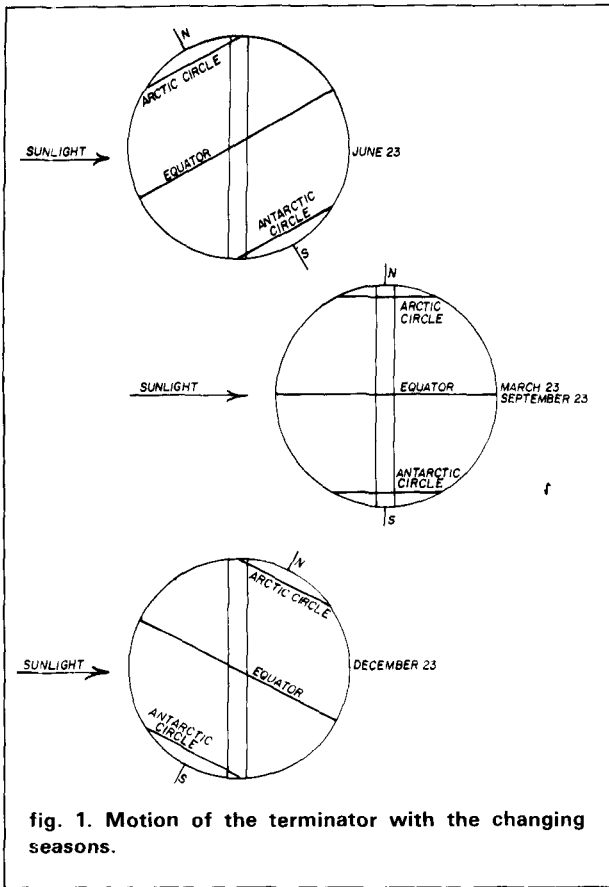

tics. Thus, the ionosphere in the twilight regions of Earth is in a state of flux and rapidly changing conditions prevail.

Because of the rapidly shifting properties of the ionosphere within this region, propagation of certain frequencies along the terminator is extremely efficient. Fig. 2 represents a cross-sectional view of the terminator and the ionosphere in and around this region. Within the daylight hemisphere, both the D-layer and F-layer are near their peak levels of ionization. High levels of ionization cause the D-layer to become an

effective absorber of radio frequency energy within the frequency range of 300 kHz to approximately 10 MHz. While the F-layer is capable of refracting radio signals within this range of frequencies, the high levels of absorption within the D-layer prevent these signals from reaching the F-layer. This explains why the 160, 80, and 40-meter bands are essentially nighttime bands except for local or regional communications.

### visualizing grayline

To visualize how grayline propagation works, examine station "A" in fig. 2. Located in the daylight hemisphere, its 40-meter signal is severely attenuated as it passes through the D-layer. That signal which remains is refracted by the F-layer, only to be further attenuated as it passes through the D-layer on its return path. Some RF energy will, in fact, reach the surface, but it will be well below the threshold of detectability in Amateur receivers. The only way to avoid this dilemma would be to increase power to levels well above those allowed in the Amateur service or to increase integration time of receiver detection systems well beyond that which is required for either CW or SSB.

Station "C," in fig. 2, suffers from the opposite problem. The D-layer is nonexistent due to the lack of solar radiation, but because of changes in the F-layer, the MUF (Maximum Usable Frequency) has dropped below 7 MHz. As a consequence, the 40-meter signal radiated by station "C" penetrates the ionosphere and is lost.

Now look at station "B," located in the terminator region on the Earth's surface. Signals radiated toward the daylight region are as severely attenuated as those of station "A," while the signals radiated toward the nighttime region pass through the ionosphere, as are those of station "C." It would seem that station "B" is in no more a favored position than those other two stations. Fig. 3 illustrates what would happen in actual operation. Signals radiated parallel to the terminator are propagated for long distances with little attenuation.

Because the terminator, shown in fig. 3, extends completely around the Earth, it is possible to work into any area of the world within this region. This situation is most noticeable on 80 and 40 meters and, to a lesser degree, on 20, 30, and 160 meters. Since these low-band signals suffer little attenuation on this path, long distance communications are possible with low power levels and ordinary non-directional antennas, such as dipoles and verticals.

There are, unfortunately, some areas of the world you'll never be able to work using grayline; this is because any two selected areas on the surface of the Earth do not necessarily share a common terminator. If the Earth's rotational axis were tilted 45 degrees from the plane of the ecliptic, then, at some time or other

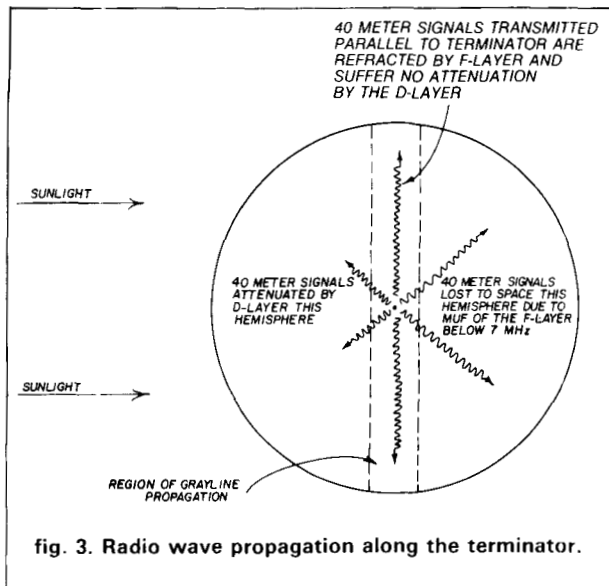

during the year, your QTH would be on the terminator with every other spot on the Earth's surface. In addition, the position of the terminator and hence the path of grayline propagation is not stationary, but instead moves with the changing seasons because of the yearly movement of the Earth's rotational axis with respect to the Sun.

Two other factors enter into grayline DXing. Remember that local time will vary all along the length of the terminator. Since most Amateurs are more active in the local afternoon and early evening, rather than at dawn, time your operating to coincide with that time when *they* are most active. Thus, to work hams on the other side of the world with this mode, the best time would be between 30 minutes before to 30 minutes after your local sunrise. In addition, remember that the position of the terminator at sunrise is not the same as its position at sunset, local time.

Figs. 4, 5, and 6 show the positions of the terminator at various times throughout the year. Notice that the only time the sunrise and sunset paths coincide is twice a year, during the spring and fall equinoxes. *The information shown in these three charts is valid only for a station located in the Pacific Northwest and will be different for stations located elsewhere.\** It is apparent that a station in Seattle could work half of Africa, Europe, much of Asia, parts of South America, and much of the South Pacific during the course of a year using grayline propagation on 80 and 40 meters.

### determining grayline paths

There are several methods used to determine grayline paths for your location. The easiest, but most cumbersome, involves the use of a globe and a piece of thin cardboard. Any globe will do, even the type sold as piggybanks in the local five-and-dime. Cut a

circular hole in the center of the cardboard just big enough to allow it to slip over the globe. It can then be positioned on the globe to represent the grayline path during any particular day of the year. This method can also be used to determine the grayline path for

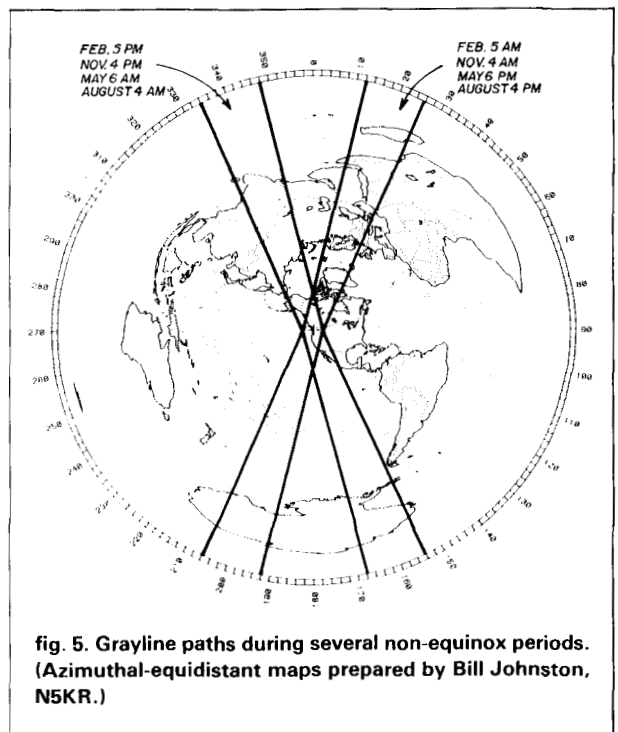
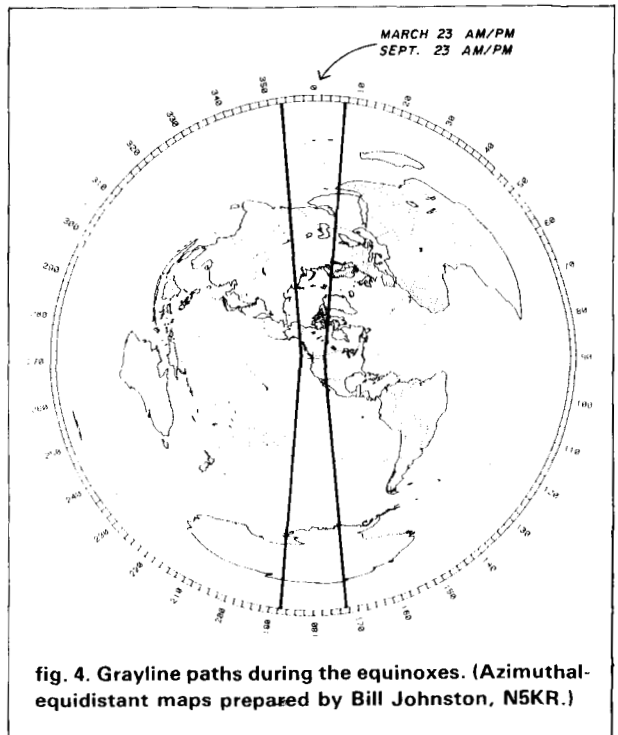

\* Custom-made azimuthal-equidistant (great circle) maps centered on your own location are available from Bill Johnston, N5KR, 1808 Pomona Drive, Las Cruces, New Mexico 88001.

**DO YOU  
KNOW  
WHERE  
TO FIND  
REAL  
BARGAINS**

**NUTS & VOLTS**  
BUY • SELL • TRADE ELECTRONICS

**HAM GEAR  
COMPUTERS  
SOFTWARE  
SCANNERS • OPTICS  
TEST EQUIPMENT  
MICROWAVE  
SATELLITE  
AUDIO VISUAL  
NEW PRODUCTS  
COMPONENTS • KITS  
ANTIQUE ELECT.  
PUBLICATIONS  
PLANS • SERVICES**

**on NEW and USED  
ELECTRONIC Equipment?**

**You'll Find Them  
in the Nation's No. 1  
Electronic Shopper Magazine**

# NUTS & VOLTS

**Now in Our 5th Year**

Nuts & Volts is published MONTHLY and features:  
**NEW STATE-OF-THE-ART PRODUCTS •  
SURPLUS EQUIPMENT • USED BARGAINS  
• LOW COST AD RATES • PRIVATE AND  
COMMERCIAL CLASSIFIEDS • NATIONAL  
CIRCULATION • NEW PRODUCT NEWS  
SECTION • FREE CLASSIFIED AD WITH  
SUBSCRIPTION**

### SUBSCRIPTION RATES

- One Year - 3rd Class Mail ..... \$7.00
- One Year - 1st Class Mail ..... \$12.50
- One Year - Canada & Mexico (in U.S. Funds) .. \$15.00
- Lifetime - 3rd Class Mail (U.S. Only) ..... \$25.00

**ORDER NOW! Rates Go Up in October!**

SEND:     CHECK         MONEY ORDER  
           VISA             MASTERCARD

TO:        **NUTS & VOLTS MAGAZINE**  
              **P.O. BOX 1111-H**  
              **PLACENTIA, CALIFORNIA 92670**  
              **(714) 632-7721**

Name \_\_\_\_\_

Address \_\_\_\_\_

City \_\_\_\_\_

State \_\_\_\_\_ Zip \_\_\_\_\_

Card No. \_\_\_\_\_

Exp. Date \_\_\_\_\_

**IF YOU'RE INTO ELECTRONICS,  
THIS MAGAZINE WILL SAVE YOU MONEY!**

Dealer Inquiries Invited

✓ 173

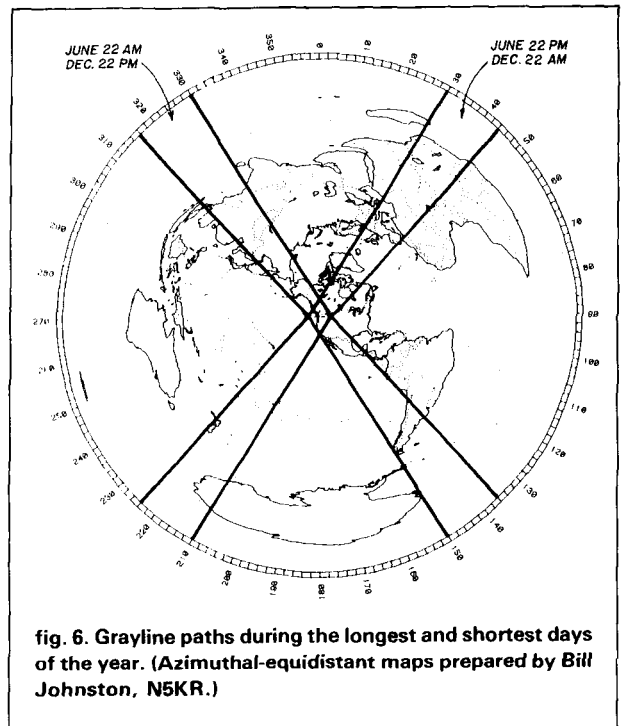

fig. 6. Grayline paths during the longest and shortest days of the year. (Azimuthal-equidistant maps prepared by Bill Johnston, N5KR.)

selected times during the year and plot the results on a map as was done in figs. 4, 5, and 6. (These base maps are available through a number of sources, most of which advertise in the various Amateur magazines.) By taking the time to devise three sets of maps, the approximate grayline path for any day of the year can be quickly and easily determined.

Perhaps the most convenient method of figuring grayline paths is through the use of "The DX Edge," slide rule-type device with a map of the world printed on one side and equipped with a series of overlays representing the grayline paths for each month of the year.\* By sliding the appropriate overlay back and forth along the map, the path of the terminator across the Earth's surface is easily determined.

Regardless of the method used, figuring and using grayline propagation paths will enhance your ability to work low-band DX. Of course, the old adage "The higher the antenna, the better" is still true. But the fact that you don't have a directional antenna array or a 2000 watt amplifier is no excuse for not snagging the rare ones. Patience, perserverance, and a knowledge of grayline propagation will catch all the 80 and 40-meter DX you can handle, and you won't have to stay up until two o'clock in the morning to do it.

### Bibliography

Hoppe, D., K6UA, Dalton, P., W6NLZ, and Capossela, F., K6SSS, "The Grayline Method of DXing," *CQ*, September, 1975.

Jacobs, George, W3ASK, and Cohen, Theodore, N4XX, *The Shortwave Propagation Handbook*, CQ Publishing, Inc., Hicksville, New York, 1982.

*ARRL Ham Radio Operating Guide*, American Radio Relay League, Newington, Connecticut, 1976.

**ham radio**

\*DX Edge is available from Ham Radio's Bookstore, Greenville, New Hampshire 03048 (\$16.95 plus \$1.50 postage and handling).



# DXing by computer

Program determines  
grayline, distance/azimuth,  
and MUF/FOT

**You're an avid contester** who needs an elusive KX6 multiplier on 10 and 15 meters during the VK/ZL contest in October; when should you spend time looking for this rare prefix? Or perhaps you don't care too much about DXing, but are interested in talking with a friend in Pakistan; which band and at what time should you expect propagation to be at its best? Or maybe you've heard about grayline propagation, but don't know how to tell what countries are on the grayline or when to try to make contact with them. What's the beam heading to South Africa? How far is the long path distance? If you do make contact with your friend in Australia, how good will the band conditions be? Should you use CW or SSB? It's questions such as these that suggest that the only way to manage the variety and volume of information available to Amateurs is by computer.

The user-friendly program described in this article consolidates the best features of many programs already on the market. It makes available, for the first time, a means of accurately determining the sunrise and sunset grayline for any location on the earth and for any desired day during a year.

A summary of the program's features is shown below, and a short discussion of the outputs follows.

In addition, several examples of how to use the program are demonstrated by answering some of the questions raised at the beginning of the article.

User inputs (data entered) include the date, base location, the name of any of 433 target locations (countries, states, or provinces), DX location (target), 10.7 cm solar flux, geomagnetic A factor, and the grayline desired and its width.

Printed program outputs include the grayline output and screen output. Computer inputs include the following:

**Base sunrise/sunset times.** This is normally the user's operating location sunrise/sunset times given in UTC, or more popularly, GMT. The algorithm used to calculate the sunrise and sunset times has been extensively compared to world and nautical almanacs and *no error greater than 1 minute has been found.*

**Target sunrise/sunset times.** If the target selected is a single point — that is, one specific location — the output will give only the target average sunrise/sunset time. If you have chosen a country for your target location, and the country is large enough to have significantly different sunrise/sunset times, then the output will include a *minimum and maximum* sunrise and sunset time. This output can be used to determine the coincident darkness and daylight between you and the desired target. In general, look for 10 and 15-meter openings during daylight coincidences (except in years of very high sunspot activity). Look for openings on

**By Van Brollini, NS6N, 5861 Bridle Way, San Jose, California 95123, and Walter Buchanan, 6569 Belbrook Court, San Jose, California 95120**

40, 80, and 160 meters during darkness coincidences. Twenty meters is normally open most days and nearly through the night to some areas of the world.

**Long/short path output.** The program computes the long path and short path great circle distance in nautical miles (*1 nautical mile = 1.15 statute miles = 1.85 kilometers*) and also computes the long and short path compass beam headings between the user's operating location and the desired target location.

**Sunspot number/quality factor.** The program determines the sunspot number based on the 10.7 cm solar flux. The quality factor comes from the August, 1982, issue of *ham radio* and is an empirical means of describing the quality of a QSO, with 0 being poor and 9 being very good.<sup>1</sup>

**MUF/FOT.** The MUF or Maximum Usable Frequency is a definite boundary that the HF user cannot overcome with power, antenna, or other mechanical means. The MUF is the range of frequencies that can be used before radio waves penetrate the F layer and not return to earth. *Because of minimum signal absorption at this frequency, the MUF gives the greatest signal strength at the receiving point for a given transmitted power.* Fifty percent of the month the highest propagated frequency achieves this value — MUF. Ninety percent of the month, the highest propagated frequency will achieve the value known as FOT (Frequency of Optimum Transmission). FOT is also included in the program and uses the same algorithm as was used to do MUF. This section of the program makes use of information provided by Robert Rose, K6GKU, on MINIMUMUF.<sup>2</sup>

**Grayline.** Observation has shown that enhanced conditions for working DX often occur at sunrise and sunset. This is particularly true when both the base location and the desired target location are undergoing sunrise or sunset at the same time. This section of the program provides an easy means of determining who else in the world is experiencing sunrise or sunset at the same time that you are. The grayline is the great circle path that describes the line drawn on the earth that separates the half that is in daylight from the half in darkness. The width of the grayline is a variable that is determined by the user; for most applications, a time window of  $\pm \frac{1}{2}$  hour is sufficient to determine which countries can be found. This corresponds to a grayline width of 15 degrees.

The two questions that are answered by this part of the program are first, for any day, when will my sunrise/sunset occur? And second, what will be the bearing of the grayline, and what targets will lie along it?

**table 1. Program output display showing information and format available.**

(1) JAN 1				PATH	
	LAT	LONG		SHORT	LONG
(2) BASE	00:00	000:00	DIST	0	21600
(3) TGT	00:00	000:00	HEAD	0	180
			SUNRISE	SUNSET	
BASE			05:59	18:07	(4) GEO-MAG 0
TGT-AVE			05:59	18:07	(4) 10.7 cm 64
TGT-MIN					SUNSPOT 0
TGT-MAX					Q-FACT 4.1
(5) MAXIMUM USABLE FREQUENCY (FOT (6))					
00	05	10	15	20	
01	06	11	16	21	
02	07	12	17	22	
03	08	13	18	23	
04	09	14	19	24	
ENTER 1-6, (G)-LINE, (P)RINT					

As you can see from the list above, the number of inputs needed is really very small and readily available from just a few sources. Using any world atlas, the latitude and longitude of the base location — this is *where you are* — can be determined. Again, using the world atlas, any specific target location — this is *where you want to go* — can be obtained. The data base of 433 unique radio locations stored in the program eliminates the need to know or look up the latitude or longitude of a specific country; all you need to know is the name of the country. The 10.7 cm solar flux and the geomagnetic A index can be obtained from WWV. Listen to any of the assigned frequencies you are able to receive, (2.5, 5, 10, 15 and 20 MHz) at 18 minutes past the hour or use the hotline telephone number (303-497-3235). The program uses the 10.7 cm flux to calculate the sunspot number, and the geomagnetic A index to determine the quality factor. The two final items that the program needs are the date for which you wish to calculate the program outputs, and the width of the grayline.

## using the program

After the program is loaded, the monitor will display information similar to that shown in **table 1**. Three distinct sections are seen on the screen and in **table 1**: data, coordinates, distances and headings; sunrise, sunset, and the geophysical information; and MUF and FOT. The numbers in brackets indicate where the user must input data to the program. All input routines are user-friendly and have built-in error detection to prevent data that is out of range: for example, February 31 or a 10.7 cm solar flux of 0 (minimum solar

**table 2. Kansas to Marshall Island path parameters.**

OCT 15

	LAT	LONG	PATH	
			SHORT	LONG
BASE	37:00	100:00	DIST 4802	16798
			HEAD 275	95

TARGET NAME: MARSHALL ISLANDS

TARGET PREFIX: KX

	SUNRISE	SUNSET	GEO-MAG 8.0
BASE	12:46	00:06	
TGT-AVE	18:08	06:04	10.7 cm 133.0
TGT-MIN	18:08	06:04	SUNSPOT 86
TGT-MAX	18:08	06:04	Q-FACT 4.9

**MAXIMUM USABLE FREQUENCY**

0	30.9	5	16.8	10	13.1	15	14.4	20	29.0
1	28.6	6	15.7	11	12.7	16	13.7	21	31.1
2	25.0	7	14.9	12	12.4	17	17.6	22	32.6
3	19.5	8	14.1	13	12.2	18	22.7	23	32.4
4	18.0	9	13.6	14	15.1	19	26.3	24	30.9

**FREQUENCY OF OPTIMUM TRANSMISSION**

0	26.2	5	14.2	10	11.1	15	12.2	20	24.7
1	24.3	6	13.4	11	10.8	16	11.7	21	26.4
2	21.3	7	12.6	12	10.6	17	14.9	22	27.7
3	16.6	8	12.0	13	10.4	18	19.3	23	27.5
4	15.3	9	11.5	14	12.8	19	22.4	24	26.2

**table 3. Kansas to Pakistan path parameters.**

APR 15

	LAT	LONG	PATH	
			SHORT	LONG
BASE	37:00	100:00	DIST 6723	14877
			HEAD 11	191

TARGET NAME: PAKISTAN

TARGET PREFIX: AP

	SUNRISE	SUNSET	GEO-MAG 8.0
BASE	12:08	01:13	
TGT-AVE	01:03	13:55	10.7 cm 133.0
TGT-MIN	00:25	13:28	SUNSPOT 86
TGT-MAX	01:33	14:22	Q-FACT 4.9

**MAXIMUM USABLE FREQUENCY**

0	9.0	5	8.9	10	10.2	15	14.9	20	9.1
1	12.3	6	8.3	11	13.1	16	13.0	21	8.5
2	13.5	7	7.9	12	14.6	17	11.7	22	8.0
3	10.9	8	7.5	13	15.7	18	10.7	23	7.6
4	9.6	9	7.2	14	16.1	19	9.9	24	9.0

**FREQUENCY OF OPTIMUM TRANSMISSION**

0	7.7	5	7.6	10	8.6	15	12.6	20	7.8
1	10.5	6	7.1	11	11.1	16	11.1	21	7.3
2	11.4	7	6.7	12	12.4	17	9.9	22	6.8
3	9.3	8	6.4	13	13.4	18	9.1	23	6.5
4	8.1	9	6.1	14	13.7	19	8.4	24	7.7

flux is 63.75). The ability to perform a screen dump to get hard copy is also available, and that format will be used to answer some of the questions raised at the beginning of the article.

**Kansas to Marshall Islands**

Suppose you're a top Kansas contester who needs that KX6 prefix on 10 and 15 meters for the VK/ZL contest during the middle of October. You've determined that the geomagnetic A index is presently 8 and the 10.7 cm flux is 133. When do you look for that rare one? Once the coordinates, date, country, and the geophysical information have been entered, the computer will give the information shown in **table 2**.

The first thing to note is that the great circle distance is less than 6000 miles. Since this is within the 250 to 6000 mile range in which the MUF algorithm is most accurate, you can feel fairly comfortable about using the MUF/FOT data. By examining the MUF, you can see that the best time to start looking for a 15-meter path is approximately 1800 GMT, which corresponds to the KX6 sunrise. Looking for the KX6 on 10 meters, you should wait about two hours, according to the MUF. Because the FOT shows that 10 meters might not be too dependable, spending more time on 15 meters could prove more fruitful; you would probably look for KX6 on 15 first. If you got him, you'd then look for him on 10.

**Kansas to Pakistan**

Once you've received the greatest number of points ever accumulated in the VK/ZL contest, you decide that it would be good to talk to your friend in Pakistan. Assuming that the 10.7 cm flux and the A index have not changed, you have all the information you need to use the program. After inputting the needed data, the computer calculates the information shown in **table 3**.

Using **table 3**, the first thing you'll note is that the great circle distance is greater than 6000 miles, so you'll use the MUF and FOT data with caution. You'll see with some surprise that there is an overlap between your sunrise and sunset in Pakistan. Knowing that the best chance for a long path contact is when your sunset occurs slightly before sunrise in Pakistan, you see that you have a 20-minute window (01:13 - 01:33) for a possible try at that time. There are two peaks in the MUF; you're going to try them both to maximize your chances of hooking up with your friend. You'll also try 30 meters between 0100 and 0300 GMT and try 20 meters between 1200 and 1500 GMT.

**Texas grayline determination**

What grayline locations are available to a station in Texas during sunrise? Once you've entered your base coordinates and the date, the computer will provide the data listed in **table 4**.

**table 4. Grayline countries available to Texas at sunrise on November 15. Base latitude is 030:00. The longitude is 097:00. Sunrise is at 12:52, and sunset is at 23:33. The grayline headings are 201 and 021. For a grayline width of 16.00 degrees, these are the "gray" countries.**

COUNTRY	PREFIX	SS/SR	DISTANCE	HEADING
AFGANISTAN	YA	SS	14694	195
ALABAMA	W5-AL	SR	553	75
ÅLAND ISLAND	OH0	SS	17021	207
ARKANSAS	W5-AR	SR	383	37
ASIATIC R.S.F.S.R.	UA9-0	SS	16289	162
AZERBAIJAN	UD6	SS	15430	207
CASEY STATION	VK0	SS	13175	17
CHAGOS ISLANDS	VO9	SS	12291	204
CLIPPERTON ISLAND	FO8	SR	1433	216
COLORADO	W0-CO	SR	699	323
DENMARK	OZ	SS	17179	214
DUMONT D'URVILLE STATION	FB8Y	SS	13792	25
EASTER ISLAND	CE0A	SR	3492	193
ESTONIA	UR2	SS	16842	206
EUROPEAN R.S.F.S.R.	UA2	SS	15906	206
FINLAND	OH	SS	17060	203
FLORIDA	W4-FL	SR	744	96
GEORGIA	W4-GA	SR	688	72
GEORGIA (USSR)	UF6	SS	15666	209
GREENLAND	OX-XP	SR	3107	19
ICELAND	TF	SR	3495	29
ILLINOIS	W9-IL	SR	717	31
INDIA	VU	SS	13981	178
INDIANA	W9-IN	SR	797	38
IOWA	W0-IA	SR	732	10
IRAN	EP	SS	14930	206
JAN MAYEN	JX	SS	17912	202
KANSAS	W0-KS	SR	490	349
KARELO-FINNISH REPUBLIC	UN1	SS	16955	199
KAZAKH	UL7	SS	15500	191
KENTUCKY	W4-KY	SR	720	51
LABRADOR	VO2	SR	2077	36
LACCADIVE ISLANDS	VU7	SS	13262	194
LATVIA	UQ2	SS	16797	208
LENINGRADSKAYA STATION	UA1	SS	14253	24
LOUISIANA	W5-LA	SR	215	73
MALDIVE ISLANDS	8Q-VS9	SS	13035	197
MANITOBA	VE4	SR	1440	1
MARKET REEF	OJ0	SS	17034	206
McMJRDO	KC4	SS	14369	14
MEXICO	XE	SR	604	208
MICHIGAN	W8-MI	SR	990	29
MINNESOTA	W0-MN	SR	915	9
MISSISSIPPI	W5-MS	SR	428	72
MISSOURI	W0-MO	SR	514	20
NEBRASKA	W0-NE	SR	671	350
NEW MEXICO	W5-NM	SR	517	300
NEW YORK	W2-NY	SR	1329	48
NORTH CAROLINA	W4-NC	SR	987	64
NORTH DAKOTA	W0-ND	SR	1033	352
NORTHWEST TERRITORIES	VE8	SR	2255	353
NORWAY	LA	SS	17379	209
OHIO	W8-OH	SR	911	45
OKLAHOMA	W5-OK	SR	243	351
OMAN	A4X	SS	14155	210
ONTARIO	VE3	SR	1273	23
PAKISTAN	AP	SS	14502	195
PENNSYLVANIA	W3-PA	SR	1154	50
QUEBEC	VE2	SR	1666	31
SCOTT STATION	ZL5	SS	14369	14
SOUTH DAKOTA	W0-SD	SR	856	350
SVALBARD	JW	SS	18119	194
SWEDEN	SK	SS	17166	207
TADZHIK	UJ8	SS	14938	190
TENNESSEE	W4-TN	SR	647	53
TEXAS	W5-TX	SR	184	312
TURKOMAN	UH8	SS	15180	201
UKRAINE	UB5	SS	16268	211
UNITED ARAB EMIRATES	A6X	SS	14393	211
UZBEK	UI8	SS	15364	203
VIRGINIA	W4-VA	SR	927	55
WHITE R.S.S.R.	UC2	SS	16546	210
WISCONSIN	W9-WI	SR	907	20

WE SHIP WORLDWIDE  
**Barry Electronics Corp.**  
 WORLD WIDE AMATEUR RADIO SINCE 1950  
 Your one source for all Radio Equipment!

For the best buys in town call:  
**212-925-7000**  
 Los Precios Mas Bajos en Nueva York...

KITTY SAYS: WE ARE NOW OPEN 7 DAYS A WEEK.  
**Saturday & Sunday 10 to 5 P.M.**  
 Monday-Friday 9 to 6:30 PM Thurs. to 8 PM  
 Come to Barry's for the best buys in town.  
 For Orders Only Please Call: 800-221-2683



**ICOM**

IC-R71A, IC-751A, IC-745, IC-27AH, IC-37A  
 IC-47A, IC-271AH, IC-2KL, IC-471A, IC-290H.

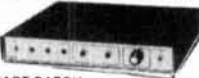

**YAESU**

FT-ONE, FT-980, FT-230R FT-750X  
 FT-726R, FT-77, FRG-7700, FT-203R

YAESU ICOM Land Mobile HT  
 FT-208R IC2AT Midland  
 FT-708R IC3AT Wilson Mini Com II  
 FTC-1903 IC4AT Yaesu FTC 2203, FT 4703  
 Icom IC M12 (Marine)  
 Tempo M-1  
 IC02AT

**SMART PATCH**  
 CES Simplex Autopatch 510 SA With Patch FM  
 Transceiver To Your Telephone. Great For  
 Telephone Calls From Mobile To Base Simple  
 To Use \$319.95

**DRAKE, EARTH SATELLITE  
 STATION, ESS-2250, ESR-24**



Nye-MB5 3 Kilowatt Tuner

**SANTEC**  
 ST-222/UP  
 ST-142/UP  
 ST-442/UP  
 HT-7

**MFJ Models**  
 900, 940B, 941C & 941D

**HAM MasterTapes—  
 Beta or VHS Tapes**

**MURCH Model**  
 UT2000B

**ONV Safety**  
 belts-in stock

**ROBOT 450C-800C-1200C**  
 Color Mod Kits

**BENCHER PADDLES &  
 Vibroplex Keys in Stock!!**

**NEW TEN-TEC** will be shipped direct  
 2591 HT, Corsair in Stock to you FREE of shipping cost

**Complete Butternut Antenna  
 Inventory in Stock!**

**LUNAR PREAMPS STOCKED  
 DENTRON IS BACK IN STOCK!**

**Long range Wireless  
 Telephone for export  
 in stock**

**Fox-Tango Filters  
 LUNAR PREAMPS STOCKED  
 DENTRON IS BACK IN STOCK!**

**Long range Wireless  
 Telephone for export  
 in stock**

**Long range Wireless  
 Telephone for export  
 in stock**

**Long range Wireless  
 Telephone for export  
 in stock**

**Long range Wireless  
 Telephone for export  
 in stock**

**Long range Wireless  
 Telephone for export  
 in stock**

**Long range Wireless  
 Telephone for export  
 in stock**

**Long range Wireless  
 Telephone for export  
 in stock**

**Long range Wireless  
 Telephone for export  
 in stock**

**Long range Wireless  
 Telephone for export  
 in stock**

**Long range Wireless  
 Telephone for export  
 in stock**

**Long range Wireless  
 Telephone for export  
 in stock**

**Long range Wireless  
 Telephone for export  
 in stock**

**Long range Wireless  
 Telephone for export  
 in stock**

**Long range Wireless  
 Telephone for export  
 in stock**

**Long range Wireless  
 Telephone for export  
 in stock**

**Long range Wireless  
 Telephone for export  
 in stock**

**Long range Wireless  
 Telephone for export  
 in stock**

**Long range Wireless  
 Telephone for export  
 in stock**

**Long range Wireless  
 Telephone for export  
 in stock**

**Long range Wireless  
 Telephone for export  
 in stock**

It's BARRY  
 For BIG LEAGUE SAVINGS

**KENWOOD**



Head  
 microphones  
 equalizers  
 stocked

R-600, R-1000, R-2000, TS-930S/AT,  
 TS 430S, TR 2500/3500, TR-9130, TR  
 7950, TW-4000A.  
 Kenwood Service/Repair.

**ROCKWELL/COLLINS  
 KWM-380**

VoCom/Mirage/Daiwa Large inventory of  
 Tokyo Hy-Power Saxton Wire & Cable  
 Amplifiers & SIB HT Gain  
 Antennas IN STOCK



Transceivers

**Computer interfaces  
 stocked: MFJ-1224**

AEA CP-1, Kantronics  
 Big Ham Clock/Ham Tags

**Complete Butternut Antenna  
 Inventory in Stock!**

**ROBOT 450C-800C-1200C**  
 Color Mod Kits

**BENCHER PADDLES &  
 Vibroplex Keys in Stock!!**

**NEW TEN-TEC** will be shipped direct  
 2591 HT, Corsair in Stock to you FREE of shipping cost

**Complete Butternut Antenna  
 Inventory in Stock!**

**LUNAR PREAMPS STOCKED  
 DENTRON IS BACK IN STOCK!**

**Long range Wireless  
 Telephone for export  
 in stock**

**Long range Wireless  
 Telephone for export  
 in stock**

**Long range Wireless  
 Telephone for export  
 in stock**

**Long range Wireless  
 Telephone for export  
 in stock**

**Long range Wireless  
 Telephone for export  
 in stock**

**Long range Wireless  
 Telephone for export  
 in stock**

**Long range Wireless  
 Telephone for export  
 in stock**

**Long range Wireless  
 Telephone for export  
 in stock**

**Long range Wireless  
 Telephone for export  
 in stock**

**Long range Wireless  
 Telephone for export  
 in stock**

**Long range Wireless  
 Telephone for export  
 in stock**

**Long range Wireless  
 Telephone for export  
 in stock**

**Long range Wireless  
 Telephone for export  
 in stock**

**Long range Wireless  
 Telephone for export  
 in stock**

**Long range Wireless  
 Telephone for export  
 in stock**

**Long range Wireless  
 Telephone for export  
 in stock**

**Long range Wireless  
 Telephone for export  
 in stock**

**Long range Wireless  
 Telephone for export  
 in stock**

**Long range Wireless  
 Telephone for export  
 in stock**

**Long range Wireless  
 Telephone for export  
 in stock**

**Long range Wireless  
 Telephone for export  
 in stock**

**Long range Wireless  
 Telephone for export  
 in stock**

**Long range Wireless  
 Telephone for export  
 in stock**

MICROLOG-AIR I in stock

**KANTRONICS  
 Interface II, software**

EIMAC  
 3-500Z  
 572B, 6JS6C  
 12BY7A &  
 4-400A

**BIRD  
 Wattmeters &  
 Elements  
 In Stock**

AEA 144 MHz  
 AEA 440 MHz  
 ANTENNAS

MAIL ALL ORDERS TO BARRY ELECTRONICS CORP., 512 BROADWAY, NEW YORK CITY, NY 10012.

**New York City's LARGEST STOCKING HAM DEALER  
 COMPLETE REPAIR LAB ON PREMISES**

**"Aqui Se Habla Espanol!"**  
 BARRY INTERNATIONAL TELEX 12-7670  
 TOP TRADES GIVEN ON USED EQUIPMENT  
 Monday-Friday 9 A.M. to 6:30 P.M.  
 Thursday to 8 P.M.  
 Saturday & Sunday 9 A.M. to 6:30 P.M. (Free parking  
 Paid parking lot across the street anytime)  
 AUTHORIZED DIST. MCKAY DYMEK FOR  
 SHORTWAVE ANTENNAS & RECEIVERS:  
 IRTILEX "Spring St. Station"  
 Subways: BMT "Prince St. Station"  
 IND "F" Train-Bwy. Station"  
 Bus: Broadway #6 to Spring St.  
 Path—9th St. 8th Ave. Station

**ORDER LINE  
 CALL  
 800-221-2683**

We Stock: AEA, ARRL, Alpha, Ameco, Antenna Specialists, Astatic, Astron, B & K, B & W, Bash, Bencher, Bird, Butternut, CDE, CES, Collins, Communications Spec. Connectors, Covercraft, Cubic (Swan), Cushcraft, Daiwa, Dentron, Digimax, Drake, ETO (Alpha), Eimac, Encomm, Heil Sound, Henry, Hustler (Newtronics), Hy-Gain, Icom, KLM, Kantronics, Larsen, MCM (Daiwa), MFJ, J.W. Miller, Mini-Products, Mirage, Newtronics, Nye Viking, Palomar, RF Products, Radio Amateur Callbook, Robot, Rockwell Collins, Saxton, Shure, Swan, Telex, Tempo, Ten-Tec, Tokyo Hi Power, Trionyx TUBES, W2AU, Waber, Wilson, Yaesu Ham and Commercial Radios, Vocom, Vibroplex, Curtis, Tri-Ex, Wacom Duplexers, Repeaters, Phelps Dodge, Fanon Intercoms, Scanners, Crystals, Radio Publications.

WE NOW STOCK COMMERCIAL COMMUNICATIONS SYSTEMS  
 DEALER INQUIRIES INVITED. PHONE IN YOUR ORDER & BE REIMBURSED  
**COMMERCIAL RADIOS STOCKED & serviced on premises.**  
**Amateur Radio & Computer Courses Given On Our Premises, Call  
 Export Orders Shipped Immediately. TELEX 12-7670**

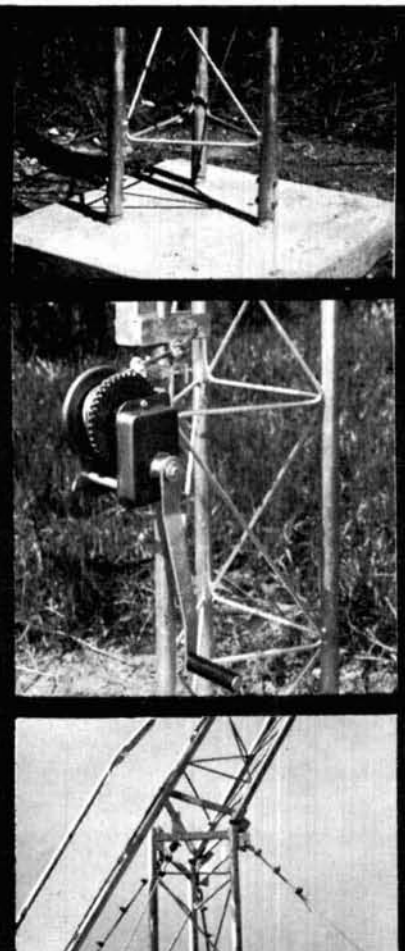

**ROHN**  
**"FOLD-OVER"  
 TOWERS**

**EASE OF INSTALLATION**  
 ROHN "Fold-Over" Towers are quickly and easily installed. The "Fold-Over" is safe and easy to service.

**ADAPTABILITY**  
 ROHN has several sizes to fit your applications or you can purchase the "Fold-Over" components to convert your ROHN tower into a "Fold-Over".

**HOT DIP GALVANIZED**  
 All ROHN towers are hot dip galvanized after fabrication.

**REPUTATION**  
 ROHN is one of the leading tower manufacturers, with over 25 years of experience.

Write today for complete details.

QUALITY STEEL PRODUCTS BY  
**ROHN**  
 Box 2000 Peoria, Illinois 61656  
 U.S.A.

**VHF COMMUNICATIONS** **ICOM DAY** **VHF COMMUNICATIONS**

**HAMBURG HAM-O-RAMA SAT. SEPT. 8, 1984**

MOSFET technology in American made mobile power amplifiers. Built for those who demand quality.

**FALCON COMMUNICATIONS**

Contact us for all of your amateur radio needs.....  
 FEATURING:  
 ICOM, AEA, LARSEN, VAN GORDEN, VIBROPLEX, NYE-VIKING, FALCON COMM. LEADING EDGE, ARRL PUBLICATIONS, KAGLO, HAMTRONICS, PROWRITER, ELEPHANT DISKS, DEBCO, TRIONYX

**1915 North Main Street  
 Jamestown, New York 14701 ✓ 192 PH. (716) 664-6345**

*Southern Tier's finest amateur radio dealer!*





**table 5.** List of long path countries from Texas at sunrise on November 15. (These countries meet the additional criterion that Texas sunrise occurs after their sunset.)

AFGHANISTAN  
EUROPEAN R.S.F.S.R.  
FINLAND  
IRAN  
KARELO-FINNISH REPUBLIC  
KAZAKH  
NORWAY  
PAKISTAN  
SWEDEN  
TURKOMAN  
UZBEK

Assume that you're interested in working only long path this morning. If you know that the best chance for a long path QSO occurs between the distant station's sunset and your sunrise, use the program to determine which of the countries listed in **table 4** meet that condition. These countries are listed in **table 5**. The value given in the **HEADING** column is the long path direction to the particular country. The program gives long path when the sunrise or sunset of the distant QTH is opposite yours.

### do it yourself?

This program is available for purchase in two versions (one with the grayline feature, DX1, and one without the grayline feature, DX2), each configured for any 64k Apple with a disk drive and 16K expander (a printer is optional; if you have one, be sure to plug it into slot No. 1). Purchase information, as well as information describing computer services available to owners of computers other than the Apple, is provided at the end of this article.

It took the two of us *nine months* to develop and debug this program. But if you'd like to try writing your own, here's what you'll need to know. Almost all the information any DX or SWL operator needs for effective operation is available in standard sources and can be written into a single program. You'll need a variety of resources — a thorough understanding of programming *your* computer — but it can be done.

Basic sources of data include a DX country list and for each country given, the appropriate coordinates; you'll also need a MUF summary, beam headings, Great Circle Distances, Sunrise and Sunset times, and a list of grayline countries. The grayline list can be generated using a variety of techniques, including calculation from sunrise/sunset times and longitude<sup>3</sup> or a slide rule-like product, *DX Edge*;<sup>\*</sup> what makes this program unique is not the data itself, but how it is assembled and made useful.

### developing the data base

From the beginning it was clear that the program would have to have a world data base that was always in memory. This would allow the other sections of the program using the data base to run at a higher speed, and eliminate the need for disk access, which would slow the program down. The program would also have to be done in a language that would allow the source code to be compiled; we chose Pascal, which allowed a structured approach to be followed and made "modular code development" possible. By using Pascal, we could write, debug, and compile each module separately. The program would also have to integrate the various data in such a way that would allow the program to be easy to use — i.e., "user friendly." It would have to "fit" into a 64k Apple.†

The most challenging part of designing this program was the development of the grayline feature; this is the area we'll discuss here in the greatest depth. The other sections of the program will be summarized, with the sources or the equations used to develop them shown in appendix A.

Using the equations shown in appendix A, you can write your own version of the program. *The version of the program shown in the examples in this article has been copyrighted*; however, all pertinent information is shown here for the benefit of *ham radio's* readers who wish to experiment with developing their own programs.

Our final world data base consists of 433 countries, states, and provinces, as well as prefixes and an average of three points per country for doing the grayline determination. A complete 15-page listing of the world data base will be provided for a 8½ × 11 SASE and \$3.00 to help defray the cost of photocopying. (Send requests directly to author.)

The final program consists of 1600 lines of code or about 26 sheets of paper requiring 61,440 bytes of storage before compilation. After the data is compiled, an additional 21,504 bytes are needed for storage. Again, note that a large portion of this program is designed to produce "friendly" input and output routines; this results in a great deal of software "overhead."

The data base required 71,440 bytes of disk storage — more than our machine's memory could accommodate. By applying a "compaction scheme," we were able to reduce the number of bytes required to 19,456.

### determining grayline

The grayline is the Great Circle path that defines or

<sup>\*</sup>*DX Edge* is available from Ham Radio's Bookstore, Greenville, New Hampshire 03048 (\$16.95 plus \$1.50 postage and handling).

†A 16k extender card must be added for the version of the program reproduced here and the purchased program as well. The cost of a 16k card is approximately \$25.00.

# RAMSEY

# THE FIRST NAME IN ELECTRONIC TEST GEAR

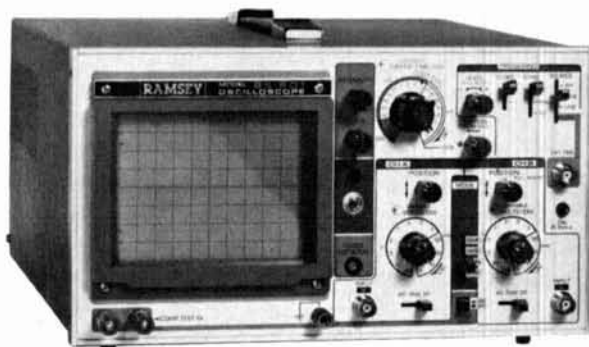

## NEW FROM RAMSEY-20 MHz DUAL TRACE OSCILLOSCOPE

Unsurpassed quality at an unbeatable price, the Ramsey oscilloscope compares to others costing hundreds more. Features include a component testing circuit that will allow you to easily test resistors, capacitors, digital circuits and diodes • TV video sync filter • wide bandwidth & high sensitivity • internal graticule • high quality rectangular CRT • front panel trace rotator • Z axis • high sensitivity x-y mode • very low power consumption • regulated power supply • built-in calibrator • rock solid triggering • high quality hook-on probes

**\$399<sup>95</sup>** high quality hook-on probes included



### RAMSEY D-1100 VOM-MULTITESTER

Compact and reliable, designed to service a wide variety of equipment. Features include • mirror back scale • double-jeweled precision moving coil • double overload protection • an ideal low cost unit for the beginner or as a spare back-up unit.

**\$19<sup>95</sup>**

test leads and battery included



### RAMSEY D-2100 DIGITAL MULTITESTER

A compact easy to use unit designed to operate like a pro. Featuring • 3 1/2 digit LCD • low BAT. indicator • all range overload protection • overrange indication • auto-polarity • Transistor tester • dual-slope integration • vinyl carrying case

**\$54<sup>95</sup>**

hFE test leads, battery & vinyl carrying case included

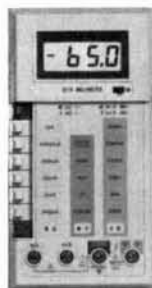

### RAMSEY D-3100 DIGITAL MULTIMETER

Reliable, accurate digital measurements at an amazingly low cost • In-line color coded push buttons, speeds range selection • abs plastic tilt stand • recessed input jacks • overload protection on all ranges • 3 1/2 digit LCD display with auto zero, auto polarity & low BAT. indicator

**\$59<sup>95</sup>**

test leads and battery included



### CT-70 7 DIGIT 525 MHz COUNTER

Lab quality at a breakthrough price. Features • 3 frequency ranges each with pre amp • dual selectable gate times • gate activity indicator • 50mV @ 150 MHz typical sensitivity • wide frequency range • 1 ppm accuracy

**\$119<sup>95</sup>**

wired includes AC adapter

CT-70 kit ..... \$99.95  
BP-4 nicad pack ..... 8.95



### CT-90 9 DIGIT 600 MHz COUNTER

The most versatile for less than \$300. Features 3 selectable gate times • 9 digits • gate indicator • display hold • 25mV @ 150 MHz typical sensitivity • 10 MHz timebase for WWV calibration • 1 ppm accuracy

**\$149<sup>95</sup>**

wired includes AC adapter

CT-90 kit ..... \$129.95  
OV-1 0.1 PPM oven timebase ..... \$9.95  
BP-4 nicad pack ..... 8.95



### CT-125 9 DIGIT 1.2 GHz COUNTER

A 9 digit counter that will outperform units costing hundreds more. • gate indicator • 24mV @ 150 MHz typical sensitivity • 9 digit display • 1 ppm accuracy • display hold • dual inputs with preamps

**\$169<sup>95</sup>**

wired includes AC adapter

BP-4 nicad pack ..... 8.95



### CT-50 8 DIGIT 600 MHz COUNTER

A versatile lab bench counter with optional receive frequency adapter, which turns the CT-50 into a digital readout for most any receiver • 25 mV @ 150 MHz typical sensitivity • 8 digit display • 1 ppm accuracy

**\$169<sup>95</sup>**

wired

CT-50 kit ..... \$139.95  
RA-1 receiver adapter kit ..... 14.95



### DM-700 DIGITAL MULTIMETER

Professional quality at a hobbyist price. Features include 26 different ranges and 5 functions • 3 1/2 digit, 1/2 inch LED display • automatic decimal placement • automatic polarity

**\$119<sup>95</sup>**

wired includes AC adapter

DM-700 kit ..... \$99.95  
MP-1 probe set ..... 4.95



### PS-2 AUDIO MULTIPLIER

The PS-2 is handy for high resolution audio resolution measurements, multiplies UP in frequency • great for PL tone measurements • multiplies by 10 or 100 • 0.01Hz resolution & built-in signal preamp/conditioner

**\$49<sup>95</sup>**

wired

PS-2 kit ..... \$39.95

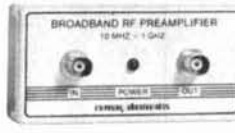

### PR-2 COUNTER PREAMP

The PR-2 is ideal for measuring weak signals from 10 to 1,000 MHz • flat 25 db gain • BNC connectors • great for sniffing RF • ideal receiver/TV preamp

**\$44<sup>95</sup>**

wired includes AC adapter

PR-2 kit ..... \$34.95



### PS-1B 600 MHz PRESCALER

Extends the range of your present counter to 600 MHz • 2 stage preamp • divide by 10 circuitry • sensitivity 25mV @ 150 MHz • BNC connectors • drives any counter

**\$59<sup>95</sup>**

wired includes AC adapter

PS-1B kit ..... \$49.95

### ACCESSORIES FOR RAMSEY COUNTERS

Telescopic whip antenna—BNC plug ..... \$ 8.95  
High impedance probe, light loading ..... 16.95  
Low pass probe, audio use ..... 16.95  
Direct probe, general purpose use ..... 13.95  
Tilt ball, for CT-70, 90, 125 ..... 3.95



PHONE ORDERS CALL  
**716-586-3950**

TELEX 466735 RAMSEY CI

TERMS: • satisfaction guaranteed • examine for 10 days; if not pleased, return in original form for refund • add 6% for shipping and insurance to a maximum of \$10.00 • overseas add 15% for surface mail • COD add \$2.50 (COD in USA only) • orders under \$15.00 add \$1.50 • NY residents add 7% sales tax • 90 day parts warranty on all kits • 1 year parts & labor warranty on all wired units.

# RAMSEY

RAMSEY ELECTRONICS, INC.  
2575 Baird Rd.  
Penfield, N.Y. 14626

separates the regions of the world that are in daylight and darkness. Each location on the globe has two graylines each day; one at sunrise and the other at sunset. In order to accurately determine the grayline, an accurate equation for sunrise is necessary. Part of the sunrise/sunset equation is the declination of the sun; the equation that describes sunrise time and sunset time and declination of the sun are shown in appendix A.

In order to determine whether or not a particular country is on the grayline, a comparison must first be made between the sunrise/sunset of the desired location and the desired country. But which coordinates should be used to describe the location of a country? Consider, for example, the USSR. This country has several different radio prefixes within it and spans thousands of miles. It's obvious, then, that any "average" of the latitude and longitude would be grossly incorrect in describing the USSR. If the country selected were Andorra, then this means of describing the country would be fully acceptable. So what's the best way to describe each country? Each country must be described (i.e., digitized with a sufficient number of points) in such a manner that during the year all minimum and maximum sunrise/sunset points will have been obtained.

By trial and error, the following approach has been successful in limiting the total number of data points necessary to describe each country.

In the rough outline drawing of the state of California (fig. 1), the extreme points of the state are emphasized. These are the points that were assumed to be the minimum number necessary to describe California as far as differences in sunrise and sunset time are concerned.

All of the points on the outline of the state were programmed into the sunrise and sunset equations shown in the appendix along with intermediate points to confirm that they were, in fact, sufficient to describe a "radio country." This approach was determined to be valid. (While the simple drawing shown in fig. 1 is far less complex than a sketch of the USSR — with its many prefixes — would be, for example, it should be easy to imagine what the final "radio country" sketch of such a vast area would look like.)

This approach was used for every country in the *DX Callbook*, for each one of the United States, for all provinces of Canada, and for any new country that could be found at the time the program was developed. Once the world data base was developed, a second data base was extracted from it and used to calculate beam headings and Great Circle distances. This second data base is essentially the average of all the given points that describe each country. In fig. 1, point E represents the average.

Readers who want to generate their own data base

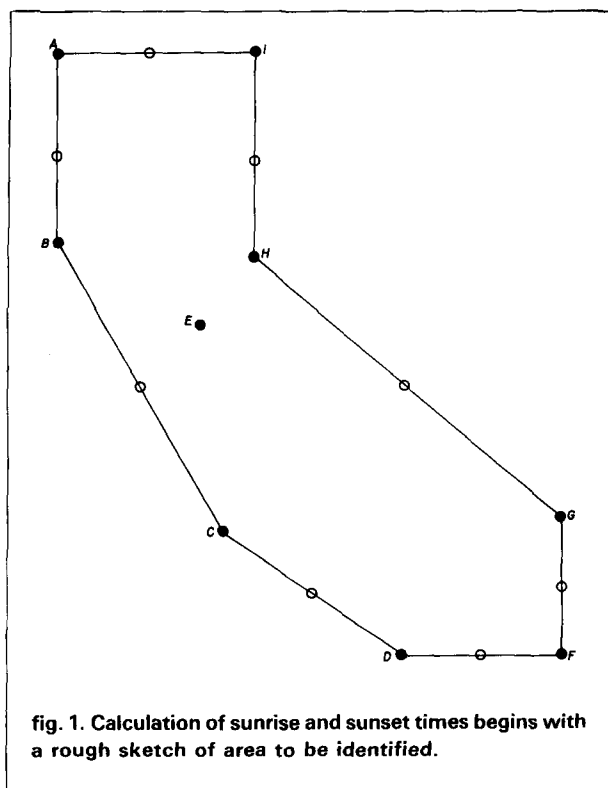

fig. 1. Calculation of sunrise and sunset times begins with a rough sketch of area to be identified.

can produce the best result if they use a computer that automatically digitizes each country and then computes sunrise and sunset times throughout the year.

### using the data base

If the sunset or sunrise time is accurately known for your location, then it's easy to determine the countries that lie on the grayline. Calculate the sunrise and sunset times for each of the points of a particular country. Since the time that the grayline occurs is identical for all the points along it, compare each of the calculated times in the countries of interest to the time at your base location. If the difference in time is within the range of time desired — typically  $\pm 1/2$  hour, or if the base sunrise/sunset lies between the minimum and maximum rise/set times, then that particular country is on the grayline.

When printing out the grayline, the subroutines for heading and distance are also used as an aid in determining long and short path propagation. The beam heading for grayline can be determined by first using the equation of time rewritten to solve for longitude. The latitude used is arbitrarily chosen to be the target latitude + or - 25 degrees. Once the longitude is found, the equation for beam heading is employed by using your base location and the arbitrarily chosen latitude and computed longitude. This will then be the grayline heading. To output long path distance, just subtract the short-path distance computed by the equation in appendix A from 21600. The final item of

# COMPUTER TRADER MAGAZINE

The monthly magazine with a natural blending of two popular hobbies — Ham Radio and Computers

- ★ Articles on Ham Radio & Most Personal Computers
  - ★ Hardware & Software Reviews
  - ★ Various Computer Languages
  - ★ Construction Articles
  - ★ Much Much More

- FREE Classified Ads for subscribers, non-subscribers - 10¢ a word/number (used equipment only)
- Excellent display ad rates

Join the CTM<sup>®</sup> readership family by subscribing NOW, during our Baker's Dozen Special.

USA .....	\$12.00 for 13 issues
Mexico, Canada .....	\$25.00
Foreign .....	\$35.00(land) - \$55.00(air)
(U.S. funds only)	
Permanent (U.S. Subscription) .....	\$100.00
Sample Copy .....	\$2.50

## CTM

Circulation Manager  
1704 Sam Drive  
Birmingham, Alabama 35235  
Phone (205) 853-0271

Name \_\_\_\_\_

Call Sign \_\_\_\_\_

Address \_\_\_\_\_

City \_\_\_\_\_ State \_\_\_\_\_

Zip \_\_\_\_\_ Phone \_\_\_\_\_

Date \_\_\_\_\_

Signature \_\_\_\_\_

✓ 131

interest that can be extracted from the data base is *whether the country that is on the grayline is going through sunrise or sunset*. Keep track of which time equation was used to match your base location time — sunrise or sunset — and make note of which one it was when printing out your listing. A brief excerpt from the program manual will show why this information is important to you:

**Daylight overlap.** Compare your sunrise with the target sunset(s). The time span between could be good for daylight openings.

**Daylight openings.** Try 10 or 15 meters, except when the sunspot number is high.

**Darkness overlap.** Compare your sunset with the target sunrise(s). The time span could be good for darkness openings.

**Darkness openings.** Try 30, 40, 80, 160 meters.

**Long-path openings.** Base sunset occurs *before* target sunrise; base sunrise occurs *after* target sunset; use long-path heading.

**Grayline openings.** Eastern paths: look *before* sunrise; western paths: look *after* your sunrise; use grayline heading.

## conclusion

With the writing of this program, we have attempted to *combine a variety of aids for the Novice or experienced operator that will free up his or her schedule for more time on the air*. For the first time, an accurate computerized grayline that leaves no doubt as to what country lies on the grayline and what time to operate is available. (This program will *not* help predict those cases in which what appears to be grayline propagation is occurring, but is one hour too early.) Propagation modes are varied and many; this program serves as a predictive tool to the ham operator and SWLer alike in providing assistance for some, but not all, modes of propagation.

## acknowledgement

We would like to acknowledge the patience that both our wives exhibited while we developed and tried to perfect this program. Many thanks also to Vern, K6VXY, for his unflagging love of CW that gave us the idea and inspiration for this program.

## references

1. Garth Stonehocker, K0RYW, "DX Forecaster," *ham radio*, August, 1982, page 80.
2. Robert Rose, K6GKU, "MINIMUF: A Simplified MUF-prediction Program for Microcomputers," *QST*, December, 1982, page 36.
3. D. Hoppe, K6UA, P. Dalton, W6NLZ, and F. Capossela, K6SSS, "The Grayline Method of DXing," *CQ*, September, 1975, page 27.
4. G.P. Stancey, G3MCK, "An Easy Method for Determining Grayline Bearings," *Radio Communication*, July, 1981, page 623.



## appendix

Use the following equations to determine base and target sunrise/sunset times, long/short path output, MUF/FOT, and gray-line. Note that some equations include additional code; be sure to include these codes to prevent "crashing" when implementing this program on your computer.

**Date-dependent constants.** This little do-loop determines the day number of the present date: for example, January 1 is Day Number 1; December 31 is Day Number 365.

```
monum='303232332323'  
FOR I = 1 TO (MONTH - 1) DO  
DAYNUM = DAYNUM + ORD(MONUM[I]) - 20;  
DAYNUM = DAYNUM + DAY;
```

### Sunrise/sunset constants.

```
pi = 3.14159265  
pj = pi / 180  
pk = 180 / pi
```

(*Lat* signifies latitude; *Lon* indicates longitude. Both are expressed in radians.)

```
DAYCONST = 0.017202 * (DAYNUM - 1.5)  
EQ_OF_T = (-1.842 * SIN(DAYCONST-0.05952)  
-2.482 * SIN(2*DAYCONST+0.3557) - 0.079 * SIN(3*DAYCONST+0.2967)  
-0.055 * SIN(4*DAYCONST+0.6981) - 0.003 * SIN(5*DAYCONST+0.7156))  
/ 15  
DECL = PJ * (0.379 - 23.267 * COS(DAYCONST+0.1793)  
-0.381 * COS(2*DAYCONST+0.1292) - 0.171 * COS(3*DAYCONST+0.5184)  
-0.008 * COS(4*DAYCONST+0.4538) - 0.003 * COS(5*DAYCONST+1.658))  
temp = 12 - eq_of_t + long * pk / 15  
temp1 = arccos((-0.01454 - sin(lat) * sin(decl)) /  
(cos(lat) * cos(decl))) * pk / 15;  
sunrise = temp - temp1  
sunset = temp + temp1
```

Answer is in decimal hours.

### Conversion of 10.7 cm flux and the quality factor.

```
sunspot number = (-0.728 + sqrt(0.728*0.728 - 4 * (63.75 - flux) * 0.00089))  
/ 0.00178;  
qual := 1.0857 * ln(flux) * (1.0 - 0.2625 * cos(8.642E-3 * daynum) *  
cos(8.642E-3 * daynum)) * exp(-0.01 * gflux) + 0.82;
```

**g flux** indicates geomagnetic flux or A factor; **flux** signifies the 10.7 cm flux as reported by WWV.

**Great Circle distance/beam headings.** (Distance expressed in radians\*; heading from Lat 1, Lon 1 to Lat 2, Lon 2. Check for poles.)

```
IF LAT1 > 1.5533 THEN LAT1 = 1.5533  
IF LAT1 < -1.5533 THEN LAT1 = -1.5533  
IF LAT2 > 1.5533 THEN LAT2 = 1.5533  
IF LAT2 < -1.5533 THEN LAT2 = -1.5533
```

\*To convert distance to nautical miles, multiply by 60 \* pk.

### Check for diametrically opposed locations.

```
IF (ABS(LON1 - LON2) > 3.124139) AND  
((-1.0 * ROUND(LAT1*120)) = (ROUND(LAT2 *120)))
```

```
THEN LON2 = LON2 + 0.01745
```

### Check for equal longitudes.

```
IF ROUND(LON1 * 120) = ROUND(LON2 * 120) THEN DISTANCE = ABS(LAT1 - LAT2)  
IF LAT1 > LAT2 THEN HEADING = PI ELSE HEADING = 0.0
```

```
DISTANCE = ARCCOS((SIN(LAT1) * SIN(LAT2) +  
COS(LAT1) * COS(LAT2) * COS(LON2 - LON1)))
```

```
HEADING = ARCCOS((SIN(LAT2) - SIN(LAT1) * COS(DISTANCE)) /  
(SIN(DISTANCE) * COS(LAT1)))
```

### Check to see if heading needs to be reversed.

```
IF SIN(LON2 - LON1) > 0.0 THEN HEADING = 2 * PI - HEADING
```

For information on how to order a copy of the program, or to obtain other DX computer services if you don't own an Apple, contact Van Brollini, NS6N, 5861 Bridle Way, San Jose, California 95123 (SASE appreciated).

ham radio

## HIGH PERFORMANCE PRESELECTOR-PREAMP

The solution to most interference, intermod, and desense problems in **AMATEUR** and **COMMERCIAL** systems.



- 40 to 1000 Mhz - tuned to your frequency
- 5 large helical resonators
- Low noise - High overload resistance
- 8 dB gain - ultimate rejection > 80 dB
- 10 to 15 volts DC operation
- Size - 1.6 x 2.6 x 4.75" exc. connectors
- **FANTASTIC REJECTION!**

#### Typical rejection:

±600 KHz@144 Mhz: -28dB  
±1.6 Mhz@220 Mhz: -40dB  
±5 Mhz@450 Mhz: -50dB

Price - **\$89.95** bipolar w/RCA jacks  
Connector options: BNC \$5, UHF \$6,  
N \$10

**SUPER HOT!** GaAs Fet option \$20

## AUTOMATIC IDENTIFIERS

ID-1

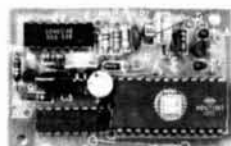

ID-2



- For transceivers and repeaters - **AMATEUR** and **COMMERCIAL**
  - Automatic operation - adjustable speed and amplitude
  - Small size - easy installation - 7 to 15 volts DC
  - 8 selectable, reprogrammable messages - each up to 2 min. long
  - Wired, tested, and programmed with your message(s)
- Model ID-1 - \$49.95 Model ID-2 w/2 to 10 minute timer - \$69.95

We offer a complete line of transmitter and receiver strips and synthesizers for amateur and commercial use.

Request our free catalog. Allow \$2 for UPS shipping - Mastercard and VISA welcome

## GLB ELECTRONICS

1952 Clinton St. Buffalo, NY 14206  
716-824-7936, 9 to 4

138

## ORR BOOKS

### BEAM ANTENNA HANDBOOK

by Bill Orr, W6SAI

Recommended reading. Commonly asked questions like: What is the best element spacing? Can different yagi antennas be stacked without losing performance? Do monoband beams outperform tribanders? Lots of construction projects, diagrams, and photos. 198 pages. ©1977. 1st edition.

RP-BA

Softbound \$7.95

### SIMPLE LOW-COST WIRE ANTENNAS

by Bill Orr, W6SAI

Learn how to build simple, economical wire antennas. Apartment dwellers take note! Fool your landlord and your neighbors with some of the "invisible" antennas found here. Well diagrammed. 192 pages. ©1972.

RP-WA

Softbound \$7.95

### THE RADIO AMATEUR ANTENNA HANDBOOK

by William I. Orr, W6SAI and Stuart Cowan, W2LX

Contains lots of well illustrated construction projects for vertical, long wire, and HF/VHF beam antennas. There is an honest judgment of antenna gain figures, information on the best and worst antenna locations and heights, a long look at the quad vs. the yagi antenna, information on baluns and how to use them, and new information on the popular Sloper and Delta Loop antennas. The text is based on proven data plus practical, on-the-air experience. **The Radio Amateur Antenna Handbook** will make a valuable and often consulted reference. 190 pages. ©1978.

RP-AH

Softbound \$7.95

### ALL ABOUT CUBICAL QUAD ANTENNAS

by Bill Orr, W6SAI

The cubical quad antenna is considered by many to be the best DX antenna because of its simple, lightweight design and high performance. You'll find quad designs for everything from the single element to the multi-element monster quad, plus a new, higher gain expanded quad (X-Q) design. There's a wealth of supplementary data on construction, feeding, tuning, and mounting quad antennas. 112 pages. ©1977.

RP-CQ

Softbound \$6.95

Please add \$1.00 to cover shipping and handling.

## HAM RADIO'S BOOKSTORE

GREENVILLE, NH 03048

## DESIGN EVOLUTION IN RF P.A.'s



Now with  
**GaAs FET  
Preamp**

- Linear (all mode) RF power amp with automatic T/R switching (adjustable delay)
- Receive preamp option, featuring GaAs FETS (lowest noise figure, better IMD). Device NF typically .5 dB.
- Thermal shutdown protection incorporated
- Remote control available
- Rugged components and construction provide for superior product quality and performance
- Affordably priced offering the best performance per dollar
- Designed to ICAS ratings, meets FCC part 97 regulations
- 1 year transistors warranty
- Add \$5 for shipping and handling (Cont. U.S.). Calif. residents add applicable sales tax.
- Specifications/price subject to change

MODEL 1	FREQUENCY 2	OUTPUT POWER	INPUT POWER	SUGG. PRICE LESS TAX
	(MHz)	(W)	(W)	\$
1410 1410G	144	160	10	225 265
1412 1412G	144	160	30	199 239
2210 2210G	220	130	10	225 265
2212 2212G	220	130	30	199 239
4410 4410G	440	100	10	225 265
4412 4412G	440	100	30	199 239

1. Models with G suffix have GaAs FET preamps. Non-G suffix units have no preamp.
2. Covers full amateur band. Specify 10 MHz Bandwidth for 420-450 MHz Amplifier.

★SEND FOR FURTHER INFORMATION★

**TE  
SYSTEMS**

**TE SYSTEMS**  
P.O. Box 25845  
Los Angeles, CA 90025  
(213) 478-0591

✓ 187

## TELEVISION MASTER ANTENNA SERVICE TECHNICIAN

Candidate must have thorough knowledge of the operation RF Transmission Lines, RF Amplifier and Television Reception Equipment.

Work will involve trouble shooting and repair of MATV Systems in multifamily buildings in the greater Boston, Southern New Hampshire area.

A background in CCTV and Intercoms while not necessary would be an advantage.

The person applying for this position must have a minimum of 3-5 years experience in this field.

Salary for this position will range from \$18,225 to \$25,500 depending on experience and previous related work background.

Call for an appointment or send resume with salary history.

### GMB SYSTEMS

110 Middlesex Street  
N. Chelmsford, Mass. 01863  
(617) 256-3000

## TOUCH TONE™ CONTROL

OUR NEW CS-16 DUAL PASSWORD  
DECODER BOARD IS THE FINAL  
SOLUTION TO REPEATER  
CONTROL SECURITY

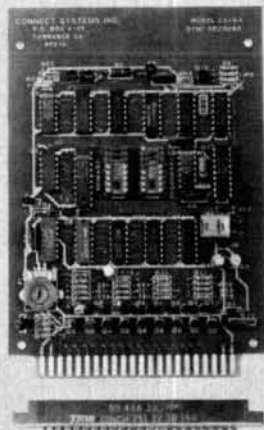

- 16 latched on/off functions
- Open collector (can drive relays directly) and logic outputs for each function.
- Two separately programmable three digit passwords allow hierarchy control
- Primary password can access all 16 functions
- Secondary password can access 8 functions
- A primary password command can enable/disable secondary password control
- Can be strapped to operate without passwords
- Adjustable pre-amp accommodates 10MV-2V input
- Retransmission of control tones can be eliminated by use of either open collector or data strobe logic outputs
- Power up reset
- XTAL controlled tone decoder
- Operates from 10 VDC to 25VDC. Reverse polarity protected
- Standard 4 1/2" x 6 1/2" glass board with 44 pin gold plated edge connector. Holes permit hard mounting
- Comes complete with manual and mating connector
- 30 day return privilege
- Limited six month warranty

CALL OR WRITE FOR BROCHURE



**\$149**



ANOTHER QUALITY PRODUCT FROM

**Connect  
Systems  
Incorporated**

23731 Madison Street  
Torrance, CA 90505  
Phone (213) 373-6803

✓ 132



# Do Kay

COMPUTER  
PRODUCTS,  
Inc.

ORDER TOLL FREE

(800)  
538-8800

(CALIFORNIA RESIDENTS)

(800)  
848-8008



## STATIC RAMS

2101	256 x 4 (450ns)	1.90
5101	256 x 4 (450ns) (cmos)	3.90
2102-1	1024 x 1 (450ns)	.88
2102L-4	1024 x 1 (450ns) (LP)	.98
2102L-2	1024 x 1 (250ns) (LP)	1.45
2111	256 x 4 (450ns)	2.45
2112	256 x 4 (450ns)	2.95
2114	1024 x 4 (450ns)	.99
2114-25	1024 x 4 (250ns)	1.10
2114L-4	1024 x 4 (450ns) (LP)	1.20
2114L-3	1024 x 4 (300ns) (LP)	1.30
2114L-2	1024 x 4 (200ns) (LP)	1.40
2125	1024 x 1	2.49
2147	4096 x 1 (55ns)	4.90
TMS4044-4	4096 x 1 (450ns)	3.45
TMS4044-3	4096 x 1 (300ns)	3.95
TMS4044-2	4096 x 1 (200ns)	4.45
MK4118	1024 x 8 (250ns)	9.90
TMM2018-200	2048 x 8 (200ns)	4.10
TMM2018-150	2048 x 8 (150ns)	4.90
TMM2018-100	2048 x 8 (100ns)	6.10
HM6116-4	2048 x 8 (200ns) (cmos)	4.70
HM6116-3	2048 x 8 (150ns) (cmos)	4.90
HM6116-2	2048 x 8 (120ns) (cmos)	8.90
HM6116LP-4	2048 x 8 (200ns) (cmos) (LP)	5.90
HM6116LP-3	2048 x 8 (150ns) (cmos) (LP)	6.90
HM6116LP-2	2048 x 8 (120ns) (cmos) (LP)	9.95
Z-6132	4096 x 8 (300ns) (Qstat)	33.95
HM6264P-15	8192 x 8 (150ns) (cmos)	38.95
HM6264LP-15	8192 x 8 (150ns) (cmos)	48.95

LP = Low Power Qstat=Quasi-Static

## DYNAMIC RAMS

TMS4027	4096 x 1 (250ns)	1.95
UPD411	4096 x 1 (300ns)	2.95
NM5280	4096 x 1 (300ns)	2.95
MK4108	8192 x 1 (200ns)	1.90
NM5298	8192 x 1 (250ns)	1.80
4116-200	16384 x 1 (200ns)	.79
4116-150	16384 x 1 (150ns)	1.20
2118	16384 x 1 (150ns) (5v)	4.90
4184-250	85536 x 1 (250ns)	4.45
4184-200	85536 x 1 (200ns) (5v)	5.45
4184-150	85536 x 1 (150ns) (5v)	6.45

5V = Single 5 Volt Supply

## EPROMS

1702	256 x 8 (1us)	4.45
2708	1024 x 8 (450ns)	2.49
2758	1024 x 8 (450ns)	2.49
2758	1024 x 8 (450ns) (5v)	5.90
2716	2048 x 8 (450ns) (5v)	2.95
2716-1	2048 x 8 (350ns) (5v)	5.90
TMS2516	2048 x 8 (450ns) (5v)	5.45
TMS2716	2048 x 8 (450ns)	7.90
TMS2532	4096 x 8 (450ns) (5v)	5.90
2732	4096 x 8 (450ns) (5v)	4.45
2732-250	4096 x 8 (250ns) (5v)	8.45
2732-200	4096 x 8 (200ns) (5v)	11.45
2784	8192 x 8 (450ns) (5v)	6.45
2784-250	8192 x 8 (250ns) (5v)	7.45
2784-200	8192 x 1 (200ns) (5v)	16.45
TMS2564	8192 x 8 (450ns) (5v)	14.45
MC68754	8192 x 8 (450ns) (5v) (24 pin)	38.95
27128	16384 x 8 Call	24.45

5v = Single 5 Volt Supply

## 74LS00

74LS00	.23	74LS173	.68
74LS01	.24	74LS174	.54
74LS02	.24	74LS175	.54
74LS03	.24	74LS181	2.10
74LS04	.23	74LS189	8.90
74LS05	.24	74LS190	.88
74LS08	.27	74LS191	.88
74LS09	.28	74LS192	.78
74LS10	.24	74LS193	.78
74LS11	.34	74LS194	.68
74LS12	.34	74LS195	.68
74LS13	.44	74LS196	.78
74LS14	.58	74LS197	.78
74LS15	.34	74LS221	.88
74LS20	.24	74LS240	.94
74LS21	.28	74LS241	.98
74LS22	.24	74LS242	.98
74LS26	.28	74LS243	.98
74LS27	.28	74LS244	1.25
74LS28	.34	74LS245	1.45
74LS30	.24	74LS247	.74
74LS32	.28	74LS248	.98
74LS33	.54	74LS249	.98
74LS37	.34	74LS251	.58
74LS38	.34	74LS253	.58
74LS40	.24	74LS257	.58
74LS42	.48	74LS258	.58
74LS47	.74	74LS259	2.70
74LS48	.74	74LS260	.58
74LS49	.74	74LS266	.54
74LS51	.24	74LS273	1.45
74LS54	.28	74LS275	3.30
74LS55	.28	74LS279	.48
74LS63	1.20	74LS280	1.95
74LS73	.38	74LS283	.68
74LS74	.34	74LS290	.88
74LS75	.38	74LS293	.88
74LS76	.38	74LS295	.88
74LS78	.48	74LS298	.88
74LS83	.59	74LS299	1.70
74LS85	.68	74LS323	3.45
74LS86	.38	74LS324	1.70
74LS90	.54	74LS352	1.25
74LS91	.88	74LS353	1.25
74LS92	.54	74LS363	1.30
74LS93	.54	74LS364	1.90
74LS95	.74	74LS365	.48
74LS96	.88	74LS366	.48
74LS107	.38	74LS367	.44
74LS109	.38	74LS368	.44
74LS112	.38	74LS373	1.35
74LS113	.38	74LS374	1.35
74LS114	.38	74LS377	1.35
74LS122	.44	74LS378	1.13
74LS123	.78	74LS379	1.30
74LS124	2.85	74LS385	1.85
74LS125	.48	74LS386	.44
74LS126	.48	74LS390	1.15
74LS132	.58	74LS393	1.15
74LS133	.58	74LS395	1.15
74LS136	.38	74LS399	1.45
74LS137	.98	74LS424	2.90
74LS138	.54	74LS447	.36
74LS139	.54	74LS490	1.90
74LS145	1.15	74LS624	3.95
74LS147	2.45	74LS640	2.15
74LS148	1.30	74LS645	2.15
74LS151	.54	74LS668	1.65
74LS153	.54	74LS669	1.85
74LS154	1.85	74LS670	1.45
74LS155	.68	74LS674	9.60
74LS156	.68	74LS682	3.15
74LS157	.64	74LS683	3.15
74LS158	.58	74LS684	3.15
74LS160	.68	74LS685	3.15
74LS161	.64	74LS688	2.35
74LS162	.68	74LS689	3.15
74LS163	.64	74LS783	23.95
74LS164	.68	81LS95	1.45
74LS165	.94	81LS96	1.45
74LS166	1.90	81LS97	1.45
74LS168	1.70	81LS98	1.45
74LS169	1.70	25LS2521	2.75
74LS170	1.45	25LS2569	4.20

## 7400

7400	.18	7482	.94	74172	5.90
7401	.18	7483	.49	74173	.74
7402	.18	7485	.58	74174	.88
7403	.18	7486	.34	74175	1.75
7404	.18	7489	2.10	74176	.88
7405	.24	7490	.34	74177	.74
7406	.28	7491	.39	74178	1.10
7407	.28	7492	.49	74179	1.70
7408	.23	7493	.34	74180	.74
7409	.18	7494	.64	74181	2.20
7410	.18	7495	.54	74182	.74
7411	.24	7496	.69	74184	1.95
7412	.29	7497	2.70	74185	1.95
7413	.34	74100	1.70	74190	1.10
7414	.48	74107	.29	74191	1.10
7416	.24	74109	.44	74192	.78
7417	.24	74110	.44	74193	.78
7420	.18	74111	.54	74194	.84
7421	.34	74116	1.50	74195	.84
7422	.34	74120	1.15	74196	.78
7423	.28	74121	.28	74197	.74
7425	28	74122	.44	74198	1.34
7426	.28	74123	.48	74199	1.34
7427	.28	74125	.44	74221	1.34
7428	.44	74126	1.44	74246	1.34
7430	.18	74128	.54	74247	1.24
7432	.28	74132	.44	74248	1.80
7433	.44	74136	.49	74249	1.90
7437	.28	74141	.64	74251	.74
7438	.28	74142	2.90	74259	2.20
7440	.18	74143	2.90	74265	1.30
7442	.48	74145	.59	74273	1.90
7443	.64	74147	1.75	74276	1.24
7444	.68	74148	1.75	74279	.74
7445	.68	74150	1.30	74283	1.95
7446	.68	74151	.54	74284	3.70
7447	.68	74152	.64	74285	3.70
7448	.68	74153	.54	74290	.94
7450	.18	74154	1.20	74293	.74
7451	.22	74155	.74	74298	.84
7453	.22	74156	.64	74351	2.20
7454	.22	74157	.54	74365	.64
7460	.22	74159	1.60	74366	.64
7470	.34	74160	.84	74367	.64
7472	.28	74161	.68	74368	.64
7473	.33	74162	.84	74376	2.15
7474	.32	74163	.68	74390	1.70
7475	.44	74164	.84	74393	1.30
7476	.34	74165	.84	74425	3.10
7480	.58	74166	.95	74426	.84
7481	1.05	74167	2.90	74490	2.50
		74170	1.60		

## 6500

6502	4.90
6504	6.90
6505	8.90
6507	9.90
6520	4.30
6522	6.90
6532	9.90
6545	21.50
6551	10.85

## 2 Mhz

6502A	6.90
6522A	9.90
6532A	10.95
6545A	26.95
6551A	10.95

## 3 Mhz

6502B	9.90
-------	------

## 6800

68000	58.95
6800	3.90
6802	7.90
6808	12.90
6809E	18.95
6809	10.95
6819	2.90
6820	4.30
6821	3.20
6828	13.95
6840	11.95
6843	33.95
6844	24.95
6845	13.95
6847	10.95
6850	3.20
6852	15.70
6860	9.90
6862	10.95
6867	6.90
6875	6.90
6880	2.20
6883	21.95
68047	23.95
68488	18.95

## 1 Mhz

68800	9.95
68802	21.25
68809E	28.95
68809	28.95
68810	6.90
68821	6.90
68845	18.95
68850	5.90

## 74S00

74S00	.31	74S163	1.90
74S02	.34	74S168	3.90
74S03	.34	74S169	3.90
74S04	.34	74S174	.94
74S05	.34	74S175	.94
74S08	.34	74S181	3.90
74S09	.39	74S182	2.90
74S10	.34	74S188	1.90
74S11	.34	74S189	6.90
74S15	.34	74S194	1.44
74S20	.34	74S195	1.44
74S22	.34	74S196	1.44
74S30	.34	74S197	1.44
74S32	.39	74S201	6.90
74S37	.87	74S225	7.90
74S38	.84	74S240	2.15
74S40	.34	74S241	2.15
74S51	.34	74S244	2.15
74S64	.39	74S251	.94
74S65	.39	74S253	.94
74S74	.49	74S257	.94
74S85	1.94		

### DISC CONTROLLERS

1771	14.95	2797	84.95
1791	23.95	6843	33.95
1793	25.95	8272	38.95
1795	48.95	UPD765	38.95
1797	48.95	M88876	28.95
2791	79.95	M88877	33.95
2793	79.95	1691	16.95
2795	84.95	2143	17.95

### CRYSTALS

1.0000 MHz	3.69	8.0000 MHz	2.69
1.8432 MHz	3.69	10.0000 MHz	2.69
2.0000 MHz	2.69	10.7386 MHz	2.69
2.0972 MHz	2.69	12.0000 MHz	2.69
2.4576 MHz	2.69	14.3182 MHz	2.69
3.2768 MHz	2.69	15.0000 MHz	2.69
3.5795 MHz	2.69	16.0000 MHz	2.69
4.0000 MHz	2.69	17.4300 MHz	2.69
4.1943 MHz	2.69	18.0000 MHz	2.69
4.9160 MHz	2.69	18.4320 MHz	2.69
5.0000 MHz	2.69	19.6608 MHz	2.69
5.0688 MHz	2.69	20.0000 MHz	2.69
5.1850 MHz	2.69	22.1184 MHz	2.69
5.2429 MHz	2.69	32.0000 MHz	2.69
5.7143 MHz	2.69	36.0000 MHz	2.69
6.0000 MHz	2.69	48.0000 MHz	2.69
6.1440 MHz	2.69	48.4350 MHz	2.69
6.4000 MHz	2.69	49.8900 MHz	2.69
6.5536 MHz	2.69		
32.768 KHz	1.69		

### CRYSTAL CLOCK OSCILLATORS

PART NO.	FREQUENCY	PRICE
1.000	1.0000 MHz	9.95
1.843	1.8432 MHz	9.95
2.000	2.0000 MHz	9.95
4.000	4.0000 MHz	9.95
8.000	8.0000 MHz	9.95
10.000	10.0000 MHz	9.95
16.000	16.0000 MHz	9.95
18.432	18.4320 MHz	9.95
19.660	19.6608 MHz	9.95
20.000	20.0000 MHz	9.95
32.000	32.0000 MHz	9.95

### VOLTAGE REGULATORS

7805T	.74	7905T	.84
78M05C	.34	7908T	.84
7808T	.74	7912T	.84
7812T	.74	7915T	.84
7815T	.74	7924T	.84
7824T	.74	7905K	1.44
7805K	1.34	7912K	1.44
7812K	1.34	7915K	1.44
7815K	1.34	7924K	1.44
7824K	1.34	79L05	.78
78L05	.68	79L12	.78
78L12	.68	79L15	.78
78L15	.68	LM323K	4.90
78H05K	9.90	UA78S40	1.90
78H12K	9.90		

C,T = TO-220 K = TO-3  
L = TO-92

### DIP SWITCHES

4 POSITION	.84
5 POSITION	.89
6 POSITION	.89
7 POSITION	.94
8 POSITION	.94

### IC SOCKETS

(1 to 99)

8 pin ST	.12	8 pin WW	.58
14 pin ST	.14	14 pin WW	.68
16 pin ST	.16	16 pin WW	.68
18 pin ST	.19	18 pin WW	.98
20 pin ST	.28	20 pin WW	1.04
22 pin ST	.29	22 pin WW	1.34
24 pin ST	.29	24 pin WW	1.44
28 pin ST	.39	28 pin WW	1.64
40 pin ST	.48	40 pin WW	1.94

ST = Soldertail WW = Wirewrap

### ZIF SOCKETS

16 pin ZIF	5.90
24 pin ZIF	7.90
28 pin ZIF	8.90

ZIF = TEXTTOOL (Zero Insertion Force)

### 1984

— THE IC MASTER —  
Your ticket to fast and  
easy IC selections  
**\$ 89.<sup>95</sup>**



**IBM Expansion KIT**  
Upgrade Chips  
4164 200ns 9 @ 5.45 ea.  
**micromax**

**VIEWMAX-80 149.<sup>95</sup>**

- 80 Column card for Apple II+
- Video Soft Switch
- Inverse Video
- 2 Year Warranty



**VIEWMAX-80e 129.<sup>95</sup>**

- 80 Column card for Apple IIE
  - 64K RAM expandable to 128K
- 64K RAM Upgrade 43.<sup>60</sup>**

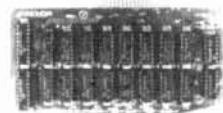

**QUV-T8/1**  
**EPROM Eraser**

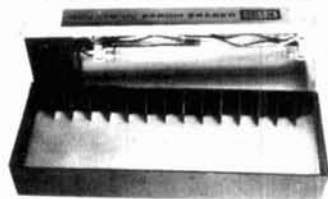

**QUV-T8/1 Economy Model:**

- Low cost EPROM eraser in plastic enclosure. The UV element is in the lid and you place the EPROMS in the bottom half. No timer or switch option.
- Erases up to 8 EPROMS in 15 - 20 minutes.
  - 12,000 uWatts at 1" distance.
  - 90-Day Warranty **49.<sup>95</sup>**

### The FLIP SORT™

The new Flip Sort™ has all the fine qualities of the original with some added benefits: a new design and 50% greater capacity. Holds 75 diskettes and the price is now lower than ever — **\$16.95**



### ATHANA

**BULK 5 1/4" DISKETTES**  
(NO LABEL)

SS/SO	15.90	SS/DD	10/14.90
SS/DD	16.90	100 up	CALL
DS/DD	22.90		

### APPLE ACCESSORIES

80 Column Apple II+	149.95
80 Column Apple IIE	129.95
Z80 Apple II+	89.00
Z80 Apple IIE	89.00
16K Card	39.95
Cooling Fan	38.95
Power Supply	74.95
Joystick	29.95
RF Modulator	13.95
Disk Drive	199.00
Controller Card	59.95

### APPLE COMPATIBLE DISK DRIVE

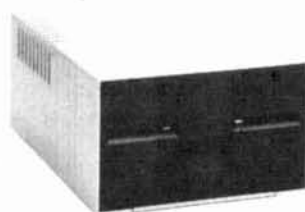

**199.<sup>00</sup>**

- Shugart mechanism, made in U.S.A.
- Directly replaces Apple Disk II
- Fully compatible with Apple Controller or other Apple compatible controllers.
- One Year Warranty

**CONTROLLER CARD... 59.95**

### COOLING FAN

**38.<sup>95</sup>**



### APPLE COMPATIBLE POWER SUPPLY

**74.<sup>95</sup>**



- Powers Apple type systems
- +5V @ 5A +12V @ 3A
- -5V @ .5A -12V @ .5A
- includes instructions

### The Flip Sort PLUS™

The new Flip Sort PLUS™ adds new dimensions to storage. Its smoked acrylic elegance holds over 100 diskettes with all the features you expect from the Flip Sort Family — **\$24.95**



### APPLE COMPATIBLE JOYSTICK

**29.<sup>95</sup>**



**16K RAM Card - Apple II+**  
• 2-Year Warranty



Assembled & Tested .... **39.95**  
For the APPLE HOBBIEIST  
**DoKay KITS:**

16K RAM card..... 24.95  
80 Column Card II+... 89.95  
Z80 Card..... 69.95  
Printer Card..... 24.95  
80 Column Card IIE ... 89.95  
**KEYBOARD (99/4)**  
48 keys 4" x 10" **6.95**



**Reg. Power Supply**  
**Model 4A/PS (99/4)**  
**3 DC Outputs:**

12V @ .4A, +5V @ 1.1A  
-5V @ .2A Highly Filtered

**6.95**



**TERMS:** Minimum order \$10.00. For shipping and handling, include \$2.50 for UPS ground or \$3.50 for UPS Blue (air). For each additional air pound, add \$1 for UPS Blue shipping and handling. California residents must include 6% sales tax; Bay area and LA residents include 6 1/2% sales tax. Prices are subject to change without notice. We are not responsible for typographical errors. We reserve the right to limit quantities and to substitute manufacturers. All merchandise subject to prior sale.

### CALL FOR VOLUME Quotes

**HOURS:** Mon. - Fri. 7:30 to 5:00  
Saturdays 10:00 to 3:00

VISIT OUR RETAIL STORE

2100 De La Cruz Blvd.  
Santa Clara, CA 95050  
(408) 988-0697

**ALL MERCHANDISE IS**  
**100% GUARANTEED**

**Telex: 756440**

**DoKay**



# ham radio TECHNIQUES

Bill Orr  
W6SAI

As of this writing (mid-June) it looks as if the FCC is slowly moving toward the possible release of additional frequencies for Amateur Radio, as authorized by the 1979 World Administrative Radio Conference. A good guess is that the so-called 24-MHz band may be released on Special Temporary Authority in the near future.

Interest in the new bands has received a boost because of the ARRL Antenna Design Competition, announced this past spring.<sup>1</sup> The goal of the contest is to provide new antenna designs that can be constructed at home and will cover as many of the

WARC-79 bands as possible. The two entry categories include a five-band design that will cover all Amateur bands between 14 and 30 MHz and a six-band design that adds the 10-MHz band. (Details are listed in table 1; a "design frequency" indicating the midpoint of each band is also listed.)

## the "multiband" antenna

The problem of designing a single antenna that covers the frequency range of 14 to 30 MHz (or 10 to 30

MHz, as the case may be) is an interesting one. No doubt many fascinating antenna designs will surface during the next few months. One basic choice that must be made is whether the antenna designed will be a wideband type that covers the entire frequency span, or a type that functions only over the bands in question. Let's look at the wideband concept first.

For this discussion, a wideband antenna is defined as one that has relatively constant gain, polarization, and

table 1. Most antennas built for the design frequency specified will work well over the whole Amateur band. Two design frequencies are chosen for 10 meters, one for operation at the low frequency end of the band and one for operation at the high frequency end.

band (MHz)	design frequency (MHz)
10.100-10.150	10.12
14.000-14.350	14.17
18.068-18.168	18.11
21.000-21.450	21.22
24.890-24.990	24.94
28.000-29.700	28.60 (low) 29.20 (high)

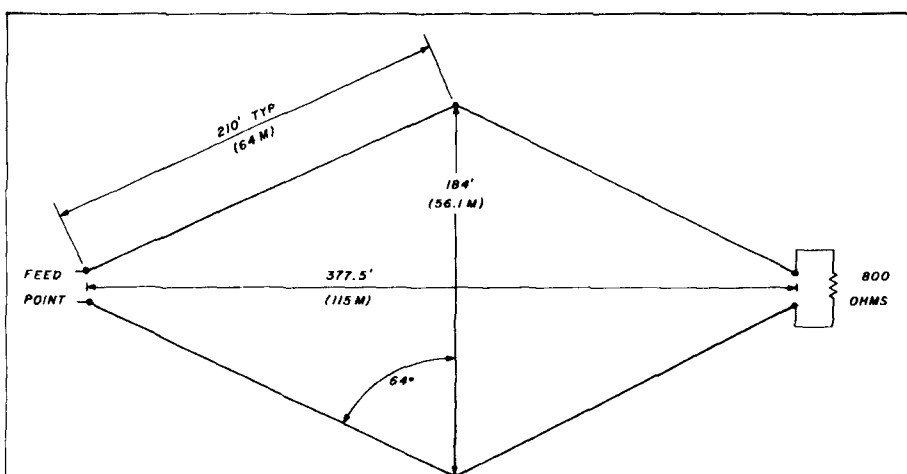

fig. 1. A terminated rhombic antenna for the frequency range of 14 to 30 MHz. Antenna is terminated with a noninductive resistor capable of dissipating about half the transmitter average power output. (Design taken from *The ARRL Antenna Book*, 14th Edition, Chapter 7, fig. 16.)

impedance characteristics over the operating range.

One of the earliest wideband gain antennas is the terminated rhombic<sup>2</sup> shown in **fig. 1**. This antenna works well over a 2-to-1 frequency range, provides good front-to-back ratio and can exhibit as high as 14 dB gain over a dipole, providing the leg-length of the array is long enough. The front-to-back ratio is achieved by choice of leg length and the use of a terminating resistor, at the far end of the array, which absorbs reflected power. Because the feedpoint resistance is about 750 to 800 ohms, an impedance matching transformer is required to match the antenna illustrated in **fig. 1** to a 50-ohm transmission line.

Other varieties of traveling-wave antennas, such as the terminated V-antenna, exist, but their main disadvantage is their large size and the corresponding amount of real estate they require.

### the log-periodic array

Two relatively new types of wideband antennas, the equiangular antenna and the log-periodic antenna, are more practical for Amateur service.

The equiangular antenna evolved from the observation that the properties of an antenna (impedance and pattern) are determined by its shape and dimensions with respect to operating wavelength. When the antenna is scaled, its properties are independent of frequency, provided its form is specified only by angles and not by any particular dimension. A two-arm equiangular spiral antenna, shown in **fig. 2**, is an example of this design.

This antenna is a variation of the dipole, where the two halves have been twisted into a pair of equiangular arms. The antenna is fed by a balanced line at the center point. High frequency cutoff is determined by antenna configuration near the feedpoint; low frequency cutoff is determined by the outer circumference of the spiral, indicated by the dashed line. Feedpoint resistance of the antenna is quite high, being of the order of 120 to 180 ohms, depending upon antenna size and de-

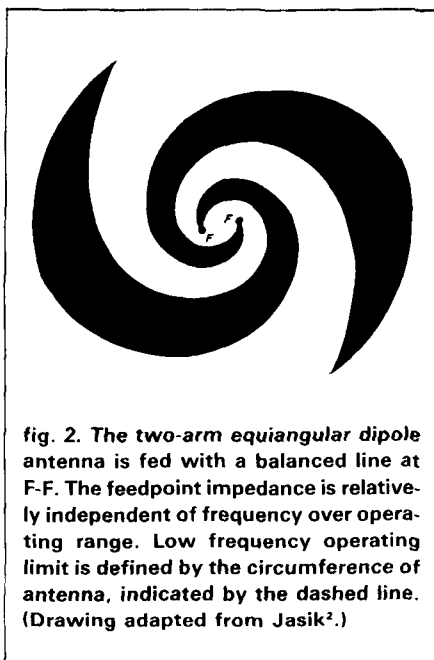

**fig. 2.** The two-arm equiangular dipole antenna is fed with a balanced line at F-F. The feedpoint impedance is relatively independent of frequency over operating range. Low frequency operating limit is defined by the circumference of antenna, indicated by the dashed line. (Drawing adapted from Jasik<sup>2</sup>.)

sign. Frequency spans as great as 10-to-1 have been achieved in practice with this antenna type.

A second wideband antenna design, with which most Amateurs are familiar, is the log-periodic antenna (**fig. 3**).<sup>\*</sup> The geometry of this antenna design is chosen so that the electrical properties repeat periodically with the logarithm of frequency. The basic trapezoidal-tooth log periodic structure is shown in the illustration.

The design can be further simplified if the structure is replaced by dipole elements (**fig. 4**). This log-periodic dipole antenna is a popular design for TV and FM receiving antennas, and versions of this antenna are often used by Amateurs on the VHF bands. The frequency limits of this antenna are those at which the outer elements are about one-half wavelength long.

The dipoles are fed at the center from a parallel wire transmission line in such fashion that successive dipoles have 180-degree phase reversal between them. A broadband structure is formed, with most of the radiation coming from the section containing elements approximately half a wavelength long at the operating frequency. Gain and bandwidth bear a definite relationship to the length and included angle of the antenna.

Unfortunately, at any given frequency in the operating passband, some of the elements in this array are inactive; the active element area moves along the structure as the frequency of operation is changed. At the lowest operating frequency, the longest elements have the most current in them and, as operating frequency is raised, the center elements become active and have the greatest current in them. At the upper frequency of operation, the shortest elements have the greatest current in them, with the longer elements relatively inactive. Thus a log-periodic dipole beam antenna must be considerably longer than a parasitic Yagi antenna of equivalent gain.

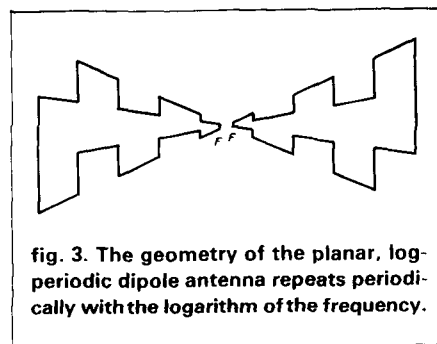

**fig. 3.** The geometry of the planar, log-periodic dipole antenna repeats periodically with the logarithm of the frequency.

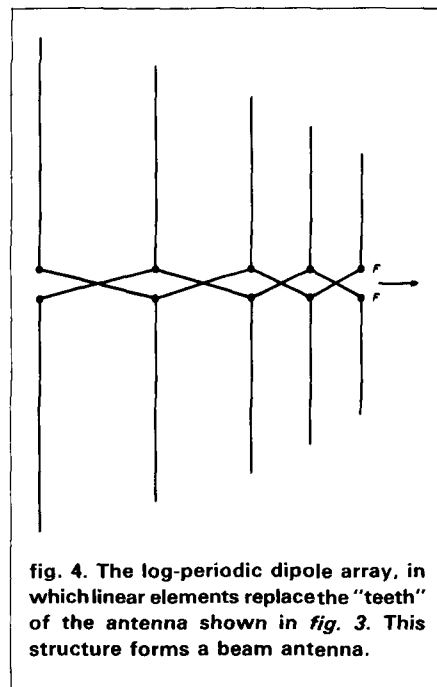

**fig. 4.** The log-periodic dipole array, in which linear elements replace the "teeth" of the antenna shown in **fig. 3**. This structure forms a beam antenna.

<sup>\*</sup>Designed by KLM Electronics, Morgan Hill, California 95037.

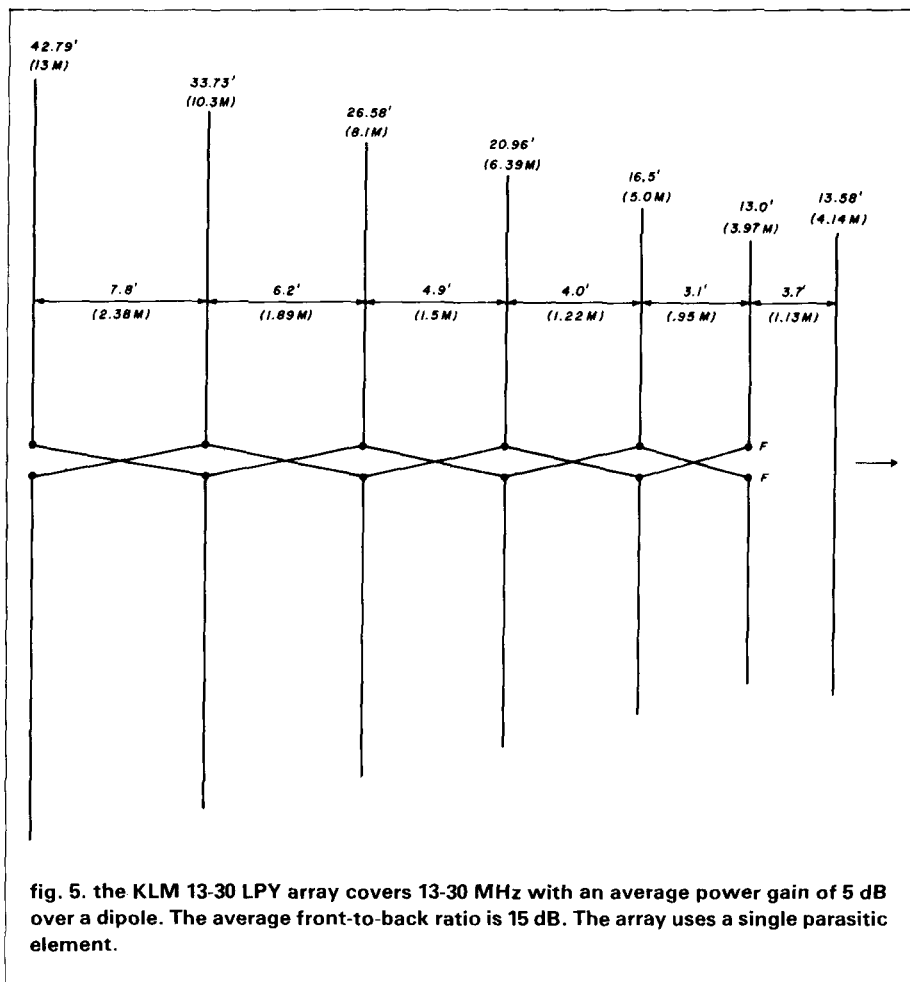

fig. 5. the KLM 13-30 LPY array covers 13-30 MHz with an average power gain of 5 dB over a dipole. The average front-to-back ratio is 15 dB. The array uses a single parasitic element.

## the log-periodic Yagi

An interesting version of the log-periodic design is the log-periodic Yagi (LPY) antenna (fig. 5). This passband array provides higher gain per unit of length than the original designs, making use of a log-periodic dipole structure having the frequency characteristics of a bandpass filter. One or more parasitic elements are used to boost the gain of the log-periodic structure. Trimming the parasitics to specific frequencies can enhance the gain of the array at these frequencies at the expense of gain loss at other frequencies. Thus, an LPY antenna can be designed for maximum performance in closely adjacent Amateur bands (14, 18, 21, and 24 MHz, for example).

Other interesting wideband antennas exist but are not practical for use in the HF spectrum because of their size.

## narrowband tuned antennas

The easiest way to get on one of the proposed new HF Amateur bands is to use a dipole cut to the midpoint of the band. A more useful antenna is a half-wave wire cut to the lowest band (for example, 10 MHz) and fed at the center with an open wire transmission line and an antenna tuner (fig. 6).

This is a very simple antenna and, when properly built and tuned, will cover all Amateur bands between 10 and 29.7 MHz. In fact, if the tuner is flexible enough, this antenna can also be used for the 40 and 80-meter bands, thus making a true "all-band" HF antenna.

At my station, I have an old John-son Kilowatt "Matchbox" tuner that I picked up at a flea market. No longer made, this useful device will match almost anything at any frequency in the HF region. With this, or an equivalent

tuner, the center-fed antenna dimensions are not critical at all because the tuner makes up for variation in antenna and feeder length. If difficulty is experienced in loading up a particular combination of flat-top/feeder lengths, adding or subtracting a foot or two of feeder length will usually cure the problem.

## parallel-connected dipoles

A simple multiband antenna used in the HF region consists of two or more dipoles connected in parallel at the feedpoint. The ends of the dipoles are separated a foot or two. This arrangement works well when the bands are harmonically related (7, 14, and 24 MHz, for example), but problems arise when the principle is applied to the new HF bands. Dipoles for 18 and 24 MHz, for example, when paralleled in this fashion do not seem to perform properly. The 18-MHz dipole is unaffected, but the 24-MHz dipole is completely detuned and will not perform at all! Other combinations have not been tried, to my knowledge, but perhaps one of *ham radio's* readers will try different combinations, such as 10 and 14 MHz, or 14 and 24 MHz. I think the parallel-dipole approach has merit, but I haven't hit upon the lucky combination that works for the new bands.

## the multiband loop antenna

One interesting antenna that will cover five or six bands when used with an open wire line and tuner is the quarter-wave loop antenna (fig. 7). With each side cut to 24 feet 6 inches (7.47 meters), the loop will cover five bands from 10 MHz up through 30 MHz. Most loops of this type are mounted in the vertical plane and fed at the bottom to provide horizontal polarization. Some experimenters have had luck with this loop mounted in the horizontal plane, about 30 to 40 feet above the ground. Horizontal polarization is still provided.

If operation is desired only on 10 MHz and up, the sides of the loop can be reduced to 13 feet 9 inches (4.14 meters).

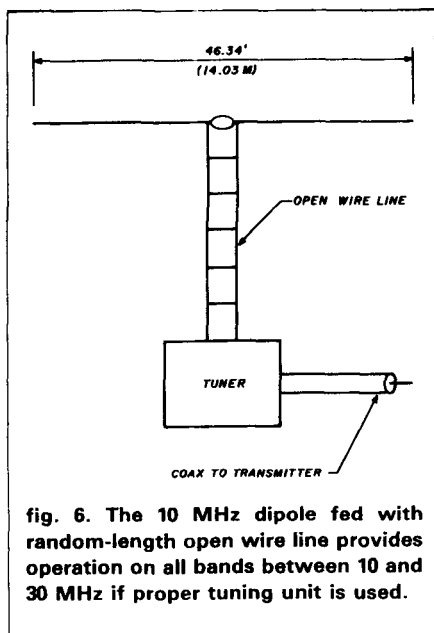

fig. 6. The 10 MHz dipole fed with random-length open wire line provides operation on all bands between 10 and 30 MHz if proper tuning unit is used.

### the trap dipole

The trap dipole (fig. 8) makes use of the high impedance of a parallel resonant circuit to isolate or decouple unwanted tip portions of the antenna. The inner set of traps is placed in the element to isolate the center portion for operation on the highest frequency band ( $f_1$ ). A second set of traps may be placed somewhat farther out along the element to isolate a longer portion, with the first set of traps becoming part of the antenna element at the lower operating frequency ( $f_2$ ). Trap dipole antennas have been built with eight traps to allow operation on four Amateur bands. Trap design is straightforward, but determining the length of the tip sections, and the wire length between the traps is usually done on a cut-and-try basis.\*

An approximate system for mathematically determining the length of the tip sections has been described in the Amateur literature.<sup>3</sup>

### trap construction

Traps can be built either with discrete components (inductors and capacitors) or by using a length of coaxial line as a combined inductor and

\*An article on a computer-aided design for a trap antenna is scheduled for publication in October. — Editor

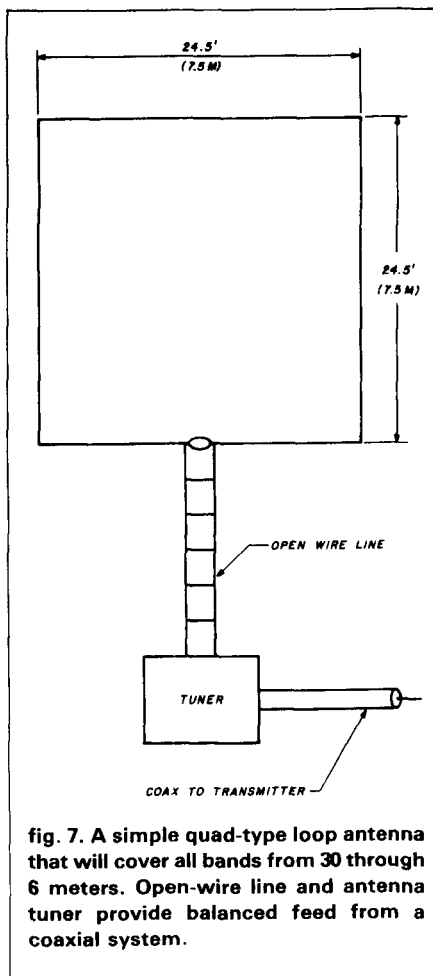

fig. 7. A simple quad-type loop antenna that will cover all bands from 30 through 6 meters. Open-wire line and antenna tuner provide balanced feed from a coaxial system.

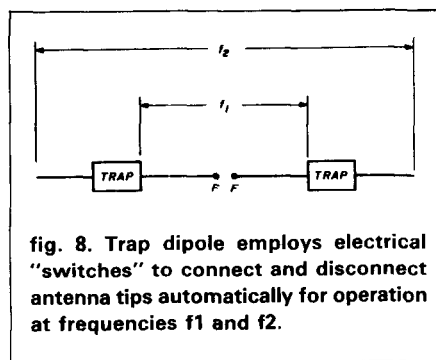

fig. 8. Trap dipole employs electrical "switches" to connect and disconnect antenna tips automatically for operation at frequencies  $f_1$  and  $f_2$ .

capacitor. Gary O'Neil, N3GO, described an interesting coaxial cable trap in *ham radio*, just a few years ago.<sup>4</sup> While his design provided somewhat better operational bandwidth than the conventional trap design, unfortunately, any form of trap made of coaxial cable is very difficult to accurately adjust to frequency because any variation in the spacing of the coiled

cable can change the resonant frequency of the trap many hundreds of kilohertz. Trap construction and adjustment become quite a problem.

The trap made up of a capacitor and a separate inductor is easier to adjust to frequency, which is usually chosen as the midpoint of the band. A fixed, high voltage capacitor is commonly used; one popular unit is a 25 pF, 5 kV ceramic type.\* Frequency can be adjusted by pruning the parallel-connected coil. Many Amateurs use pre-wound, spaced air inductors mounted on four plastic strips. One type of coil, the "mininductor" manufactured by Barker & Williamson Co., is suitable for this purpose.†

Unfortunately a trap made up of an air coil and a ceramic capacitor must be protected from the weather. Water can damage the capacitor, and ultraviolet light from the sun can quickly ruin the plastic strips supporting the coil! Solving these problems is not an easy task, and any ideas supplied by the readers as to the design of a weatherproof trap assembly would be appreciated.

### practical two-band dipole for 18 and 24 MHz

Here's a simple antenna you can build in anticipation of the happy day when the 18 and 24-MHz bands are made available to Radio Amateurs for general communication. Important antenna dimensions are shown in fig. 9. The traps are made of a coil-capacitor combination, as discussed previously, and mounted to a small ceramic insulator which serves to take the pull of the antenna.

Before the traps are installed, they must be frequency-checked with a dip oscillator and a calibrated receiver. Place the trap in an area free of nearby metallic objects and loosely couple the dip oscillator to it. When reso-

\*The popular Centralab type 850 capacitors are no longer made by this company. I understand an equivalent type is manufactured by Jennings Radio Co., 970 McLaughlin Avenue, San Jose, California 95122, and also by High Energy Corp., Lower Valley Road, Parkersburg, Pennsylvania 19365.

†Barker & Williamson Co., 10 Canal Street, Bristol, Pennsylvania 19007

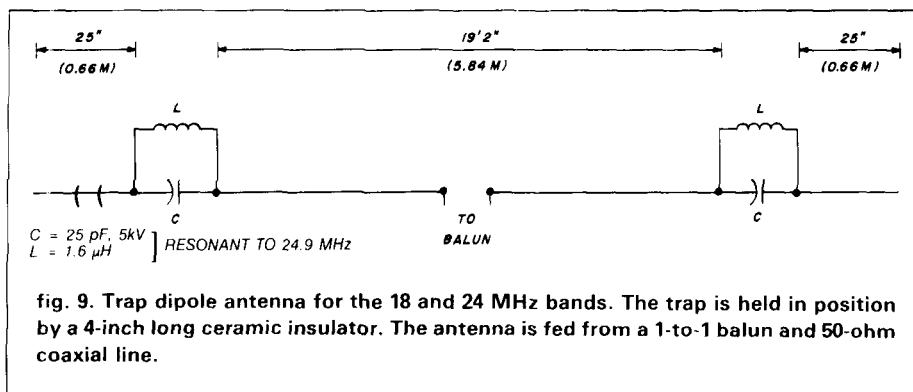

# ALPHA DELTA Tech Notes

## ALPHA DELTA ANTENNA and AC LINE PROTECTORS — the inside story

- Who Needs Them
- Do They Really Work
- Why Are There Several Different Models

### Who Needs Them

Lightning is the most common cause of component damage. However, we occasionally run into those who say "I've never been hit by lightning" or "I live on the West Coast and we don't have much lightning." Don't be fooled. There are demons lurking everywhere from your AC line to antenna that can damage your gear. Before exposing those, let's look at data about thunderstorms.

On average, the number of annual days with thunderstorms per area are approximately: West Coast, 5; Southwest, 20 to 40; Texas, 40 to 70; Midwest, 40 to 50; East Coast, 30 to 50; South, 50 to 70; and Florida, up to 100! Really, no matter where you live, you should be aware and protected from the potential for lightning-induced damage.

Now, what about what you can't see that does damage equipment? Dry desert winds in the Southwest and West Coast, wind driven snow and summer cloud buildup are all generators of enormous amounts of static electricity. Static-induced voltages from any one of these conditions can build up levels of 3 kV or more! If you've ever had the occasion to watch the static discharge jumping from the end of a long wire hanging near a chassis, you'll know what we mean.

What's worse, this type of damage is not always catastrophic. Semiconductors can suffer junction damage and will degrade over a period of weeks or months, causing subtle system problems and a gradual loss of sensitivity.

In the case of AC line protection, semiconductors are known to be damaged by transients caused by AC motors starting and switches, surges from power company "brown-outs" and poor regulation and even the effects of fluorescent lighting. If you have had the chance to see a graphic printout from an AC wall socket analyzer, you wouldn't plug anything in again that was unprotected.

So who needs Alpha Delta? Everyone. Regardless of season or geographic location.

nance is indicated, note the frequency of the oscillator on the nearby receiver. The traps should show resonance within  $\pm 100$  kHz of 24.9 MHz. One end turn on each trap should be broken free of the coil bars so that it can be moved about to set the exact resonant point of the trap. You'll find that when you attach the trap across the supporting insulator, the resonant frequency will drop a bit because of the capacitance across the insulator. It's best to shoot for a resonant trap frequency about 24.9 MHz; the insulator capacitance will then place your trap "right on the nose." You can also run your checks after assembly — take your choice.

The length of the other tip sections is critical for proper operation on 18 MHz. Varying the tip length by as little as one inch per end will change the resonant frequency about 150 kHz. Since the band is only 100 kHz wide, this means tip dimensions are critical to about an inch to establish antenna resonance within the band.

The tip dimensions shown in **fig. 1** are quite accurate. If you want to frequency-check the whole antenna, suspend it in the air, in the clear, about six feet above the ground. Place a 1/2-turn inductor across the center insulator, and measure the 18 and 24 MHz frequencies of the complete antenna with a dip oscillator coupled to the inductor.

When I made my antenna I cut the tip sections about a foot longer than necessary and then folded them back and twisted the wires around the active antenna wire. That provided

plenty of extra wire in case I had to lengthen the tip sections. Once I reached the correct length, I cut off the excess wire.

After some minor adjustments were made I found out that removing one inch at each end of the center dipole raised the resonant frequency of the antenna 100 kHz/inch at 24.9 MHz. (Since the length of the 24.9 MHz dipole affects the resonant frequency of the 18.1 MHz dipole, pruning the 24.9 MHz dipole must be done before the tip sections are adjusted.)

When the antenna was completely tuned, it was hauled up my tower and anchored at the 45-foot level, with the ends dropping down to the 25-foot level and tied to two nearby trees. SWR measurements revealed that the maximum figure on either range was under 1.3-to-1, with near-unity SWR at the design frequency on each band.

*Note: More information on multi-band antennas and trap antennas can be found in the 22nd edition of **Radio Handbook**, available from Ham Radio's Bookstore, Greenville, NH 03048, at \$21.95, postpaid.*

### references

1. "Announcing the ARRL Antenna Design Competition," *QST*, March, 1984, page 56.
2. E. Bruce, A.C. Beck, and L.R. Lowry, "Horizontal Rhombic Antennas," *Proceedings of the IRE*, Volume 23, January, 1935, page 24. Also, H. Jasik, "Antenna Engineering Handbook," McGraw Hill Book Co., New York, page 4-12 to 4-33.
3. "Trap Dipoles," *ARRL Antenna Handbook*, 14th Edition, 1982, American Radio Relay League, Newington, Connecticut, Chapters 8-4 and 10-5.
4. Gary E. O'Neil, N3GO, "Trapping the Mysteries of Trapped Antennas," *ham radio*, October, 1981, page 10.

ham radio



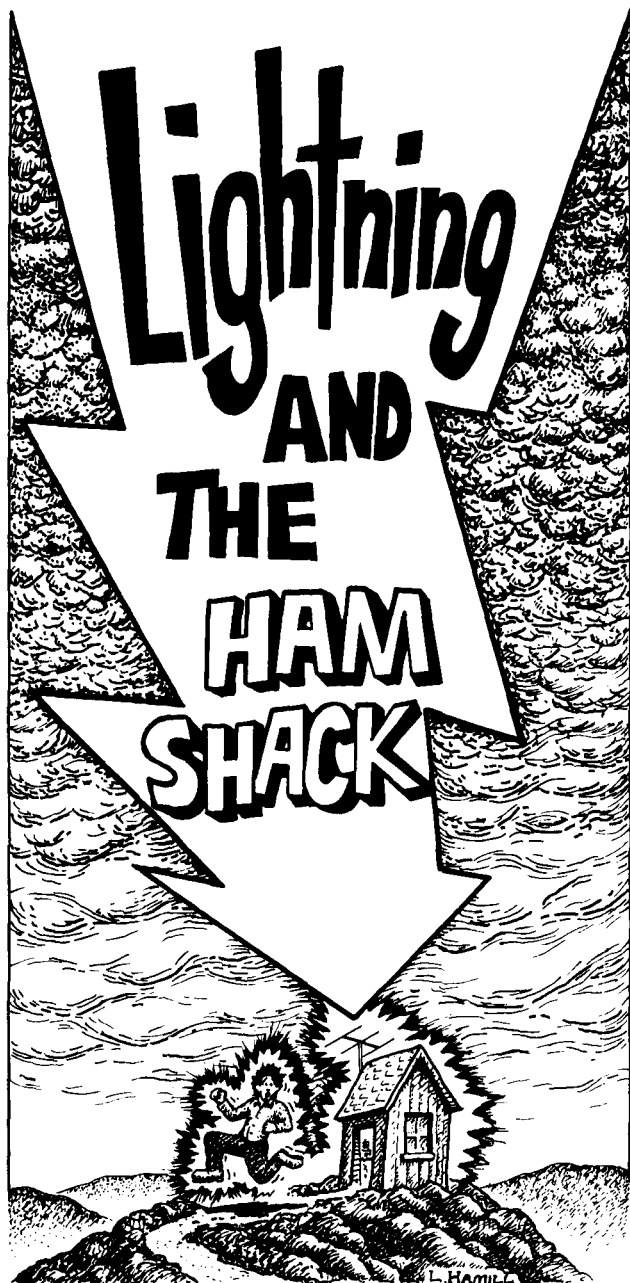

## Do They Really Work

First, let's settle one issue. Most storm damage comes from either voltage *induced* into the antenna from a near-hit lightning strike (as much as a mile away) or static buildup. No manufacturer claims their device will protect you from a direct lightning hit. That's because there is no standard by which to describe one. Some hits can generate currents of over 100,000 amperes. These might even destroy a house! Others are in the range of hundreds of amperes and may be satisfactorily by-passed to ground through a lightning protector.

Since the chances for damage from induced (non-direct hit) sources are several thousand times greater than direct hits, an effective protector has a definite place in a communications system.

Alpha Delta Transi-Trap™ ceramic gas tube protectors *do* provide effective protection because they were designed and tested to be used with the most sensitive semiconductors. They do this because they fire fast enough, (less than 100 nanoseconds), and at a low enough level to effectively by-pass the typical range of induced currents and voltages. Standard air-gap devices cannot reach this performance level due to variations in atmospheric conditions that will effect conduction of the static charge to ground.

In addition, Transi-Trap™ protectors are the only devices in the industry employing a combination of "fail-safe" isolated ground design and a field replaceable ARC-PLUG™ cartridge. Isolated ground prevents the ARC discharge from flowing to the equipment chassis via the coax shield. "Fail-safe" means the ARC-PLUG cartridge is designed to fail "shorted" instead of "open" in the event of a heavy discharge in excess of its rating. In this event, the equipment is still protected until the cartridge is replaced. Replacement is indicated by a "dead" receiver and high VSWR during tune-up.

Competitive air-gap devices suffer electrode disintegration and fail "open." You will lose your protection and you don't even know it! One competitive gas tube device is designed to melt its solder connections and fail "open" in the event of heavy current flow. The protection is gone, the element is non-replaceable and you still don't know it!

Transi-Trap™ protectors have been thoroughly tested by independent government and military test labs, and have been ordered for use around the world in a number of government and military programs. An Avionics user recently reported that since installing Transi-Trap™ devices, there has been no loss of communications due to induced transients. A leading designer of quality HF and VHF antennas, Butternut Electronics, suggests the use of Transi-Trap protectors in their literature.

A major computer manufacturer has selected MACC Master AC Control Consoles to protect their own systems from AC line transient related damage. This was done after extensive testing of all devices presently available.

## Why Are There Several Different Models

We offer a choice of models to provide the most effective cost/power/frequency/connector combination.

**STEP #1:** Select your power range. The 200-watt models are the most sensitive to transient pulses and are the best choice for receivers and transceivers. The 2 kW models are designed for overall station protection and for linear amplifiers.

**STEP #2:** Select your frequency range. The UHF "T" connector models (LT, HT) offer low insertion loss protection through 148 MHz. The lowest-loss devices are the R-T and HV (typically 0.1 dB at 500 MHz) with UHF-type connectors. The R-T and HV models utilizing type "N" or "BNC" connectors offer even less loss through 1000 MHz! They are perfect for cellular radio and STL operation in the 800 and 900 MHz ranges.

Models available are:

Model LT:	UHF "T" type, 200 W, through 148 MHz.....	19.95
Model HT:	UHF "T" type, 2 kW, through 148 MHz.....	24.95
Model R-T:	UHF connectors, 200 W, through 500 MHz.....	29.95
Model HV:	UHF connectors, 2 kW, through 500 MHz.....	32.95
Model R-T/N:	N connectors, 200 W, through 1000 MHz.....	32.95
Model HV/N:	N connectors, 2 kW, through 1000 MHz.....	35.95

(BNC connectors also available)

The surge protected MACC models are: Model MACC - 8 outlets, and master switch control 79.95. MACC-4, same as above but with 4 outlets 59.95. ACTT - wall socket direct plug-in with 2 outlets 29.95.

Alpha Delta Transi-Trap antenna line protectors and MACC Master AC Control Consoles provide more than near-hit lightning protection. They will give you protection to cover all forms of static and transient surges from your antenna to your power line — at an attractive price.

Available from your local Alpha Delta dealer or direct plus shipping \$2 Transi-Traps™, \$4 MACC.

# ALPHA DELTA COMMUNICATIONS, INC.

P.O. Box 571, Centerville, Ohio 45459 • (513) 435-4772



current solutions to current problems

# ◆ NCG CO. ◆

*Just Slightly Ahead*

## 10/160M

THE 10/160M GIVES YOU THAT EXTRA BIT OF QUALITY THAT REALLY GETS YOU THROUGH TO THAT SPECIAL DX STATION, OR JUST ENJOYING A FULLY RELAXED QSO WITH ANOTHER AMATEUR THE OTHER SIDE OF THE COUNTRY. YOUR 10/160M GIVES YOU THE EASE OF OPERATION THAT YOU WANT WITH 4 MEMORYS OR THE 3 WAY AUTO SCAN, DUAL VFO, IF SHIFT, CW-W CW-N, HAND MIC AND BUILT IN AC/DC POWER. ALL BANDS ARE FULLY OPERATIONAL INCLUDING THE NEW WARC BANDS. YOUR CHOICE OF EASY OPERATING USB, LSB, CW OR RTTY IS AT YOUR FINGER TIPS. WITH A FULL 200 WATTS PEP OUTPUT YOUR FINALS ARE PROTECTED FROM HIGH SWR.

YOUR 10/160M IS ALL SOLID STATE WITH MODULAR BOARDS THAT ARE EASY ACCESSIBLE. A BRIGHT BLUE FLUORESCENT DIGITAL DISPLAY IS EASY TO READ AT ALL TIMES.

BEST OF ALL THERE ARE NO EXTRA OPTIONS TO BUY TO GET YOU ON THE AIR, ITS ALL THERE. JUST TAKE YOUR 10/160M HOME AND 1. CONNECT A ANTENNA. 2. PLUG INTO 120V AC OUTLET. 3. TURN THE SWITCH ON. 4. SELECT THE BAND AND FREQUENCY AND YOUR ON THE AIR. YOUR RECEIVING AUDIO IS CRISP AND CLEAR, YOUR TRANSMITTED SIGNAL WILL GET YOU A PRAISE FROM EACH CONTACT. THE 10/160M GIVES YOU A SUPERIOR TRANSCEIVER THAT IS UNCOMPARABLE.

MORE INFORMATION IS AVAILABLE FROM YOUR LOCAL DEALER, OR NCG. CO.  
1275 N. Grove St., Anaheim, CA 92806

## 15M

15M-MOBILE IS YOURS TO CONTINUE YOUR QSO WITH THAT SPECIAL FRIEND WHEN YOU GO ON A VACATION OR JUST GOING TO OR FROM WORK. A TRULY QRP RIG WITH THE BIG RIG SIGNAL EITHER CW OR USB. THE DIGITAL FREQUENCY DISPLAY IS EASY TO READ AND YOUR 10 WATTS OR 2 WATTS ON USB OR CW WITH A BUILT IN SIDE TONE, HIGHLY EFFECTIVE NOISE BLANKER, AUDIO ALC GIVES DISTORTION FREE TRANSMISSION. THE VFO BALL WITH GEARS ALLOWS HIGH-PRECISION TUNING. DIGITAL DISPLAY OFFSET WHEN RIT IS IN OPERATION (A MODIFICATION THAT TAKES 5 MINUTES CHANGES THE RIT TO A FINE TUNE CONTROL). A LARGE S/RF METER IN THE CENTER AND A TOP 8 OHM .5W SPEAKER, YOUR RECEIVE AUDIO IS DIRECTED UP.

EXTERNAL SPEAKER AND CW JACKS, MOBILE MOUNTING BRACKET AND A 400 OHM PTT DYNAMIC MICROPHONE. FULL 15 METER BAND OPERATION FROM 21 to 21.450 MHZ, YOUR OFFSET FREQUENCY RANGE OR FINE TUNE IS  $\pm 4$  KHZ. THE SIGNAL TO NOISE SENSITIVITY IS MORE THAN 10DB DOWN AT -6DB INPUT. POWER SOURCE IS 13.8V DC, 3 AMPS. THE SMALL SIZE WILL ALLOW MOBILE OPERATION FROM EVEN THE SMALL CARS, ITS ONLY 9"H x 2.5W x 9.5D, THE LIGHT WEIGHT OF ONLY 5.7 LBS. MAKES THE 15M A POSSIBLE BACK PACKERS DREAM.

WITH YOUR 15M YOU WILL NOT HAVE A BIG EXPENSIVE PIECE OF EQUIPMENT SETTING IN YOUR VEHICLE, IT CAN BE UNDER THE DASH OUT OF SIGHT.



# applied Yagi antenna design

## part 4:

### a 50-MHz Tilton/Greenblum design

Computer model  
analyzes, updates  
an atypical  
Yagi design

Of the four VHF/UHF bands discussed in this series, 50 MHz is the most difficult mechanically. Where the other bands' Yagis are able to employ welding rods for the driven and parasitic elements, 50 MHz requires tubing of at least 0.5 inches (1.27 cm) in diameter. Fortunately, long enough single lengths of tubing are available so the builder can avoid the additional calculations needed to compensate for telescopic elements.<sup>1</sup> While element mounting may require methods that have some effect on element lengths, these effects are known quantities, and of relatively minor consequence.<sup>2</sup>

Because the NBS 1.2 wavelength design is often the practical limit, long-boom Yagis are not common on 50 MHz. Larger Yagis would be difficult to impossible for most 50 MHz operators; stacking would present even *more* difficulties. In effect, 50 MHz presents the VHF operator many of the antenna problems normally associated with the HF bands.

#### selecting a 50 MHz design

Lawson demonstrated that the simple Yagi per-

table 1. The baselined 50.25 MHz Yagi with parasitic element lengths supplied during iteration and the driven element fixed at the non-reactive length of 112.545495 inches.

element name	element spacing (inches)	cumulative spacing (inches)	cumulative spacing (wavelengths)
reflector	0.000	0.000	0.0000
driven	44.000	44.000	0.1873
director 1	33.000	77.000	0.3278
director 2	37.500	114.500	0.4875
director 3	45.500	163.000	0.6940
director 4	57.250	220.250	0.9377
director 5	66.125	286.375	1.2192

formed almost as well as any other antenna in the lengths feasible on 50 MHz.<sup>3</sup> Any significant improvement would have to be derived from an unequal spacing approach for the parasitic elements. Tilton presented one such design, and since its initial publication 27 years ago, it has become a standard of comparison, even being adopted by a commercial antenna manufacturer.<sup>4</sup> As is true of Tilton's other fine antennas, his six-element 50 MHz classic is based on the Greenblum design data.

Simply adding another director to Tilton's antenna for iteration purposes would result in a higher calculated gain and hopefully in a better overall pattern. But as is evident from examining Greenblum's data, there is a difference between an optimized seven-element Yagi and a six-element Yagi with an added element.

Tilton experimented with Greenblum Yagis of up to eleven elements. Of these Yagis, a seven-element 220 MHz design was published.<sup>5</sup> The design frequency appears to be 221.5 MHz, and a non-conductive boom is used. Scaling to the 50 MHz band is easily accomplished, permitting the iteration process to begin. A design frequency of 50.25 MHz was selected since a Yagi centered on this frequency can easily provide good performance across the weak signal area. **Table 1** presents spacing data for this Yagi; column two of that table contains the inter-element spacings that were calculated from those given for the 220-MHz design. The former Yagi's spacings were stated in inches and were converted to wavelengths at 221.5 MHz. These wavelengths were converted to the comparable number of inches at 50.25 MHz. For the builder's convenience, the 50.25 MHz spacings were rounded to the nearest 0.125 inch. Column three of **table 1** shows the cumulative addition of the spacings in column two, and column four is the restatement of column three in wavelengths at 50.25 MHz. All element diameters are 0.5 inches, as used in Tilton's classic. Some builders may want to use 0.75-inch tubing as is done in *The Radio Amateur's Handbook* for the NBS Yagi of this same boom length.<sup>6</sup>

#### iterating the 50-MHz Yagis

Reflector and director lengths were incremented in

By Stanley Jaffin, WB3BGU, 800 Stonington Road, Silver Spring, Maryland 20902

**table 2. A comparison of optimized 50.25 MHz Yagis for each of six different director tapering approaches.**

taper	optimized performance parameter	parasitic element length in inches		gain (dBi)	F/B (dB)
		reflector	director 1		
0.000	gain	116.000	105.750	12.493	15.192
	F/B	115.500	103.000	12.066	49.580
0.125	gain	116.000	106.000	12.481	15.624
	F/B	115.750	103.250	12.066	50.774
0.250	gain	116.000	106.500	12.469	15.109
	F/B	115.750	103.500	12.063	59.342
0.500	gain	116.000	107.000	12.441	15.843
	F/B	116.000	104.000	12.057	52.097
1.000	gain	116.000	107.750	12.375	17.878
	F/B	117.000	104.250	11.884	60.431
1.500	gain	116.250	108.500	12.301	19.108
	F/B	117.500	104.750	11.769	42.259

**table 3. Optimized gain iteration for a taper of 0.000 with a reflector length of 116.00 inches.**

director 1 (inches)	gain (dBi)	F/B (dB)
102.00	11.859	30.072
102.25	11.193	32.852
102.50	11.967	36.683
102.75	12.020	39.984
103.00	12.074	36.812
103.25	12.127	32.401
103.50	12.179	29.056
103.75	12.229	26.464
104.00	12.278	24.352
104.25	12.325	22.564
104.50	12.366	21.007
104.75	12.405	19.623
105.00	12.438	18.372
105.25	12.464	17.228
105.50	12.483	16.173
105.75	12.493	15.192
106.00	12.492	14.276
106.25	12.479	13.417
106.50	12.453	12.610
106.75	12.411	11.852
107.00	12.352	11.140
107.25	12.276	10.473
107.50	12.183	9.852
107.75	12.072	9.280
108.00	11.944	8.759
108.25	11.802	8.296
108.50	11.648	7.899
108.75	11.486	7.580
109.00	11.320	7.358
109.25	11.154	7.261
109.50	10.989	7.332
109.75	10.822	7.646
110.00	10.633	8.340

**table 4. Optimized F/B iteration for a taper of 0.000 with a reflector length of 115.50 inches.**

director 1 (inches)	gain (dBi)	F/B (dB)
102.00	11.856	27.029
102.25	11.909	29.117
102.50	11.961	32.046
102.75	12.014	36.815
103.00	12.066	49.580
103.25	12.118	41.466
103.50	12.169	33.637
103.75	12.218	29.414
104.00	12.266	26.457
104.25	12.312	24.152
104.50	12.354	22.247
104.75	12.393	20.612
105.00	12.427	19.172
105.25	12.454	17.881
105.50	12.475	16.708
105.75	12.486	15.631
106.00	12.488	14.634
106.25	12.478	13.707
106.50	12.454	12.841
106.75	12.416	12.032
107.00	12.362	11.275
107.25	12.290	10.570
107.50	12.201	9.915
107.75	12.093	9.312
108.00	11.969	8.764
108.25	11.829	8.277
108.50	11.676	7.859
108.75	11.513	7.522
109.00	11.344	7.285
109.25	11.172	7.175
109.50	10.998	7.236
109.75	10.818	7.542
110.00	10.613	8.231

0.25 inch steps, and element tapering was initially incremented in 0.5 inch steps. As a result of obtaining what appeared to be strange results for Greenblum Yagis, iterations were also made for tapers of 0.125

and 0.25 inch. All of these results are summarized in **table 2**. A zero taper clearly gives the highest calculated gain figures, even though Greenblum Yagis usually require some degree of parasitic element

# THE STANDARD OF EXCELLENCE

*The world of CW, RTTY, and new DUAL AMTOR\* is as close as your fingertips with the new brilliantly innovative state-of-the-art microcomputer controlled EXL-5000E.*

**Automatic Sender/Receiver:** Due to the most up to date computer technology, just a console and keyboard can accomplish complete automatic send/receive of Morse Code (CW), Baudot Code (RTTY), ASCII Code (RTTY) and new ARQ/FEC (AMTOR).

**Code:** Morse (CW includes Kana), Baudot (RTTY), ASCII (RTTY), JIS (RTTY), ARQ/FEC (AMTOR).

**Characters:** Alphabet, Figures, Symbols, Special Characters, Kana.

**Built-in Monitor:** 5" high resolution, delayed persistence green monitor — provides sharp clear image with no jiggle or jitter even under fluorescent lighting. Also has a provision for composite video signal output.

**Time Clock:** Displays Month, Date, Hour and Minute on the screen.

**Time/Transmission/Receiving Feature:** The built-in timer enables completely automatic TX/RX without operator's attendance.

**Selcal (Selective Calling) System:** With this feature, the unit only receives messages following a preset code. Built-in Demodulator for High Performance: Newly designed high speed RTTY demodulator has receiving capability of as fast as 300 Baud. Three-step shifts select either 170Hz, 425Hz or 850Hz shift with manual fine tune control of space channel for odd shifts. HIGH (Mark Frequency 2125Hz)/LOW (Mark Frequency 1275Hz) tone pair select. Mark only or Space only copy capability for selective fading. ARQ/FEC features incorporated.

**Crystal Controlled AFSK Modulator:** A transceiver without FSK function can transmit in RTTY mode by utilizing the high stability crystal-controlled modulator controlled by the computer.

**Photocoupler CW, FSK Keyer built-in:** Very high voltage, high current photocoupler keyer is provided for CW, FSK keying.

**Convenient ASCII Key Arrangement:** The keyboard layout is ASCII arrangement with function keys. Automatic insertion of LTR/FIG code makes operation a breeze.

**Battery Back-up Memory:** Data in the battery back-up memory, covering 72 characters x 7 channels and 24 characters x 8 channels, is retained even when the external power source is removed. Messages can be recalled from a keyboard instruction and some particular channels can be read out continuously. You can write messages into any channel while receiving.

**Large Capacity Display Memory:** Covers up to 1,280 characters. Screen Format contains 40 characters x 16 lines x 2 pages.

**Screen Display Type-Ahead Buffer Memory:** A 160-character buffer memory is displayed on the lower part of the screen.

The characters move to the left erasing one by one as soon as they are transmitted. Messages can be written during the receiving state for transmission with battery back-up memory or SEND function.

**Function Display System:** Each function (mode, channel number, speed, etc.) is displayed on the screen.

**Printer Interface:** Centronics Para Compatible interface enables easy connection of a low-cost dot printer for hard copy.

**Wide Range of Transmitting and Receiving:** Morse Code transmitting speed can be set from

the keyboard at any rate between 5-100 WPM (every word per minute). AUTOTRACK on receive. For communication in Baudot and ASCII Codes, rate is variable by a keyboard instruction between 12-300 Baud when using RTTY Modem and between 12-600 Baud when using TTL level. The variable speed feature makes the unit ideal for amateur, business and commercial use.

**Pre-load Function:** The buffer memory can store the messages written from the keyboard instead of sending them immediately. The stored messages can be sent with a keyboard command.

**"RUB-OUT" Function:** You can correct mistakes while writing messages in the buffer memory. Misspellings can also be erased while the information is still in the buffer memory.

**Automatic CR/LF:** While transmitting, CR/LF automatically sent every 64, 72 or 80 characters.

**WORD MODE operation:** Characters can be transmitted by word groupings, not every character, from the buffer memory with keyboard instruction.

**LINE MODE operation:** Characters can be transmitted by line groupings from the buffer memory.

**WORD-WRAP-AROUND operation:** In receive mode, WORD-WRAP-AROUND prevents the last word of the line from splitting in two and makes the screen easily read.

**"ECHO" Function:** With a keyboard instruction, received data can be read and sent out at the same time. This function enables a cassette tape recorder to be used as a back-up memory, and a system can be created just like telex which uses paper tape.

**Cursor Control Function:** Full cursor control (up/down, left/right) is available from the keyboard. Test Message Function: "RY" and "QBF" test messages can be repeated with this function.

**MARK-AND-BREAK (SPACE-AND-BREAK) System:** Either mark or space tone can be used to copy RTTY.

**Variable CW weights:** For CW transmission, weights (ratio of dot to dash) can be changed within the limits of 1:3-1:6.

**Audio Monitor Circuit:** A built-in audio monitor circuit with an automatic transmit/receive switch enables checking of the transmitting and receiving state. In receive mode, it is possible to check the output of the mark filter, the space filter and AGC amplifier prior to the filters.

**CW Practice Function:** The unit reads data from the hand key and displays the characters on the screen. CW keying output circuit works according to the key operation.

**CW Random Generator:** Output of CW random signal can be used as CW reading practice. **Bargraph LED Meter for Tuning:** Tuning of CW and RTTY is very easy with the bargraph LED meter. In addition, provision has been made for attachment of an oscilloscope to aid tuning.

**Built-in AC/DC:** Power supply is switchable as required; 100-120 VAC; 220-240 VAC/ 50/60Hz + 13.8VDC.

**Color:** Light grey with dark grey trim — matches most current transceivers. **Dimensions:** 363(W) x 121(H) x 351(D) mm. Terminal Unit.

**Warranty:** One Year Limited

**Specifications Subject to Change**



*Everything built in — nothing else to buy!*

EXCLUSIVE DISTRIBUTOR:

DEALER INQUIRIES INVITED

FOR YOUR NEAREST DEALER OR TO ORDER:

**AMATEUR-WHOLESALE ELECTRONICS**

**TOLL FREE ... 800-327-3102**

8817 S.W. 129th Terrace, Miami, Florida 33176

Telephone (305) 233-3631

Telex: 80-3356



MANUFACTURER:

**TONO CORPORATION**

98 Motosoja Machi, Maebashi-Shi, 371, Japan

\*Dual Amtor: Commercial quality, the EXL-5000E incorporates two completely separate modems to fully support the amateur Amtor codes and all of the CCIR recommendations 476-2 for commercial requirements.



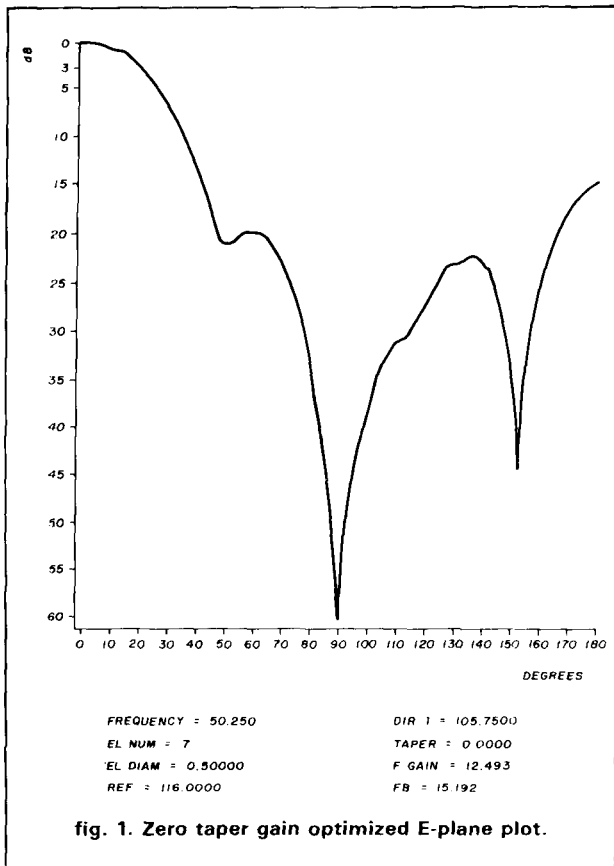

fig. 1. Zero taper gain optimized E-plane plot.

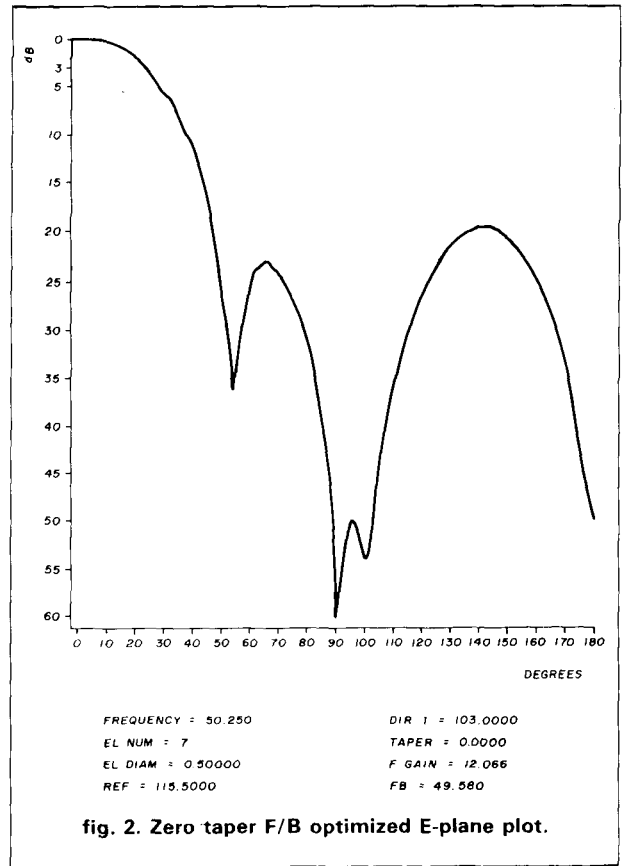

fig. 2. Zero taper F/B optimized E-plane plot.

table 5. Frequency response parameters for the gain optimized Yagi with a 0.000 taper.

frequency (MHz)	gain (dBi)	F/B (dB)
47.25	9.477	7.003
47.75	10.299	9.345
48.25	10.987	12.406
48.75	11.542	16.781
49.25	11.993	23.899
49.75	12.337	22.019
50.25	12.493	15.192
50.75	12.314	11.005
51.25	11.746	8.321
51.75	11.083	7.181
52.25	10.671	9.386
52.75	3.191	-0.549
53.25	-8.390	-14.057

table 6. Frequency response parameters for the F/B optimized Yagi with a 0.000 taper.

frequency (MHz)	gain (dBi)	F/B (dB)
47.25	8.775	5.016
47.75	9.672	6.858
48.25	10.431	9.105
48.75	11.014	11.874
49.25	11.449	15.540
49.75	11.787	21.460
50.25	12.066	49.580
50.75	12.282	21.748
51.25	12.378	15.236
51.75	12.247	11.331
52.25	11.816	8.631
52.75	11.204	6.984
53.25	10.835	7.071

tapering.<sup>7</sup> The zero taper F/B optimized Yagi, while not possessing the maximum calculated F/B, does have an outstanding F/B that is clearly representative of the F/B optimized Yagis.

Table 3 presents the iterations that identified the optimized gain of 12.493 dBi. Table 4 presents the iterations that identified the optimized F/B of 49.580 dB. Tables 5 and 6 present these antenna's respective frequency performance parameters, in 500 kHz increments across a 6 MHz bandwidth. The gain opti-

mized antenna shows a clear peak at 50.25 MHz. The F/B optimized antenna also shows a peak in the optimized parameter at 50.25 MHz, almost to the point of being of the single frequency vectorial cancellation type of F/B. Figs. 1 and 2 display these antennas' respective E-plane plots.

The comparison between these two Yagis serves to emphasize the superiority of the F/B antenna. This is the Yagi with the obviously more clearly defined main lobe and the reduced-amplitude minor lobes. With the

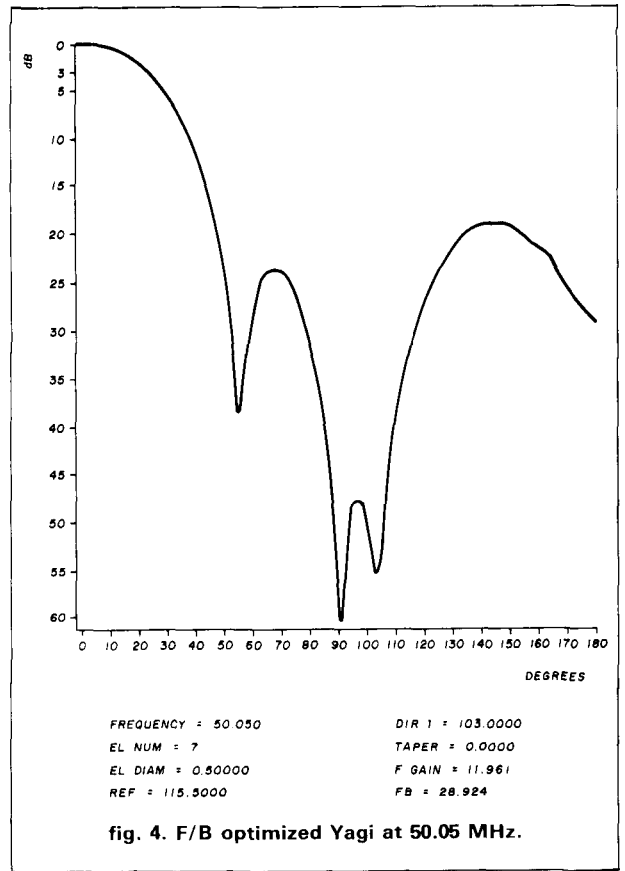
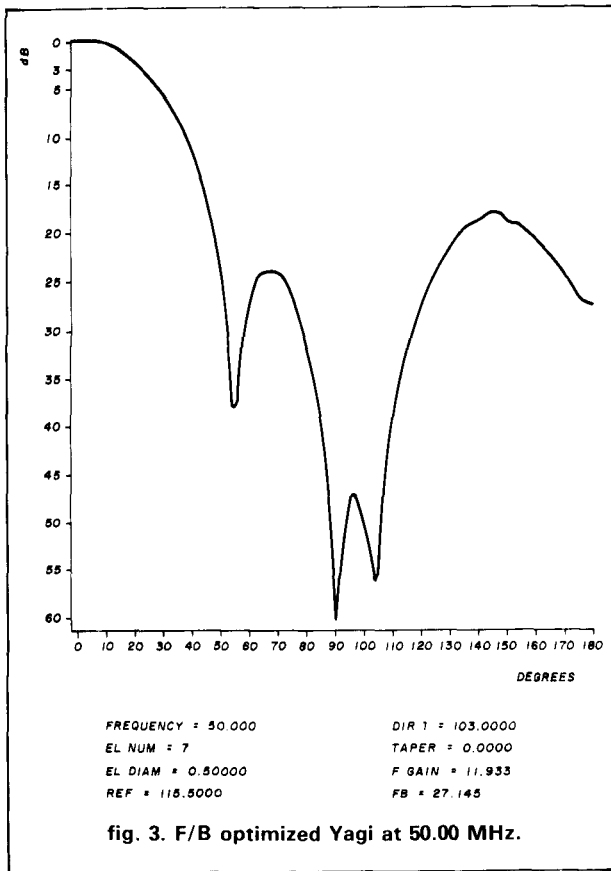

exceptions of a slightly narrower main lobe and additional unwanted signal attenuation between 132 and 158 degrees, the gain optimized Yagi is a second choice. While unwanted signals are rarely an exact 180 degrees away from desired signals, a 15 dB F/B is more or less marginal for a Yagi of this length. However, the adequacy of this F/B ratio is really a function of band activity and operator preference.

A final question, addressing the bandwidth over which the F/B optimized antenna's F/B ratio and general pattern can be realized, remains. Table 7 presents this Yagi's performance parameters as calculated from 50.0 MHz to 50.5 MHz, in 50 kHz increments. Figs. 3 through 13 contain the E-plane plots that correspond to each 50 kHz increment, with that for 50.25 MHz being repeated for purposes of clarity. Over the frequency range of interest to weak signal operators, calculated F/B begins at 31.168 dB, peaks at 49.580 dB, and drops to 33.170 dB. Calculated gain begins at 11.988 dBi and rises to 12.139 dBi. These figures serve a second purpose, as they provide a study in the effects of slight variances in frequency response on the performance criteria on which a given Yagi was optimized. It is interesting to note the emergence of another minor lobe starting at 50.3 MHz.

A comparison with the NBS 1.2 wavelength Yagi proves the value of either of the optimized Tilton/Greenblum designs. While only 0.0192 wavelengths

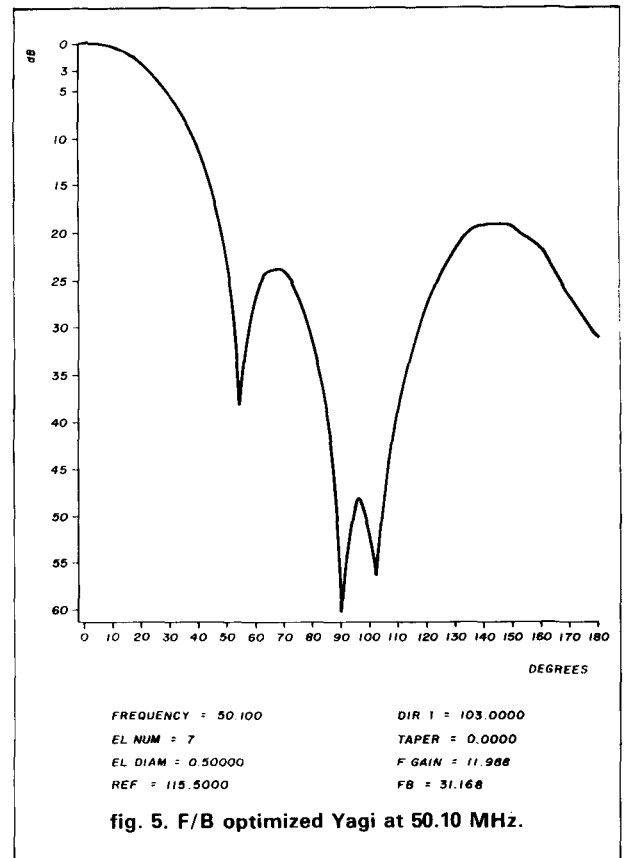

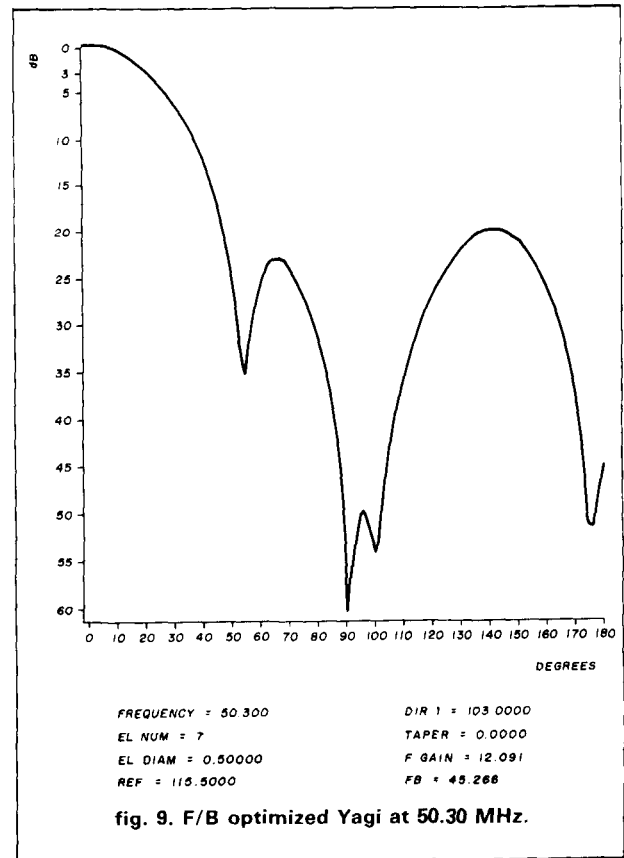
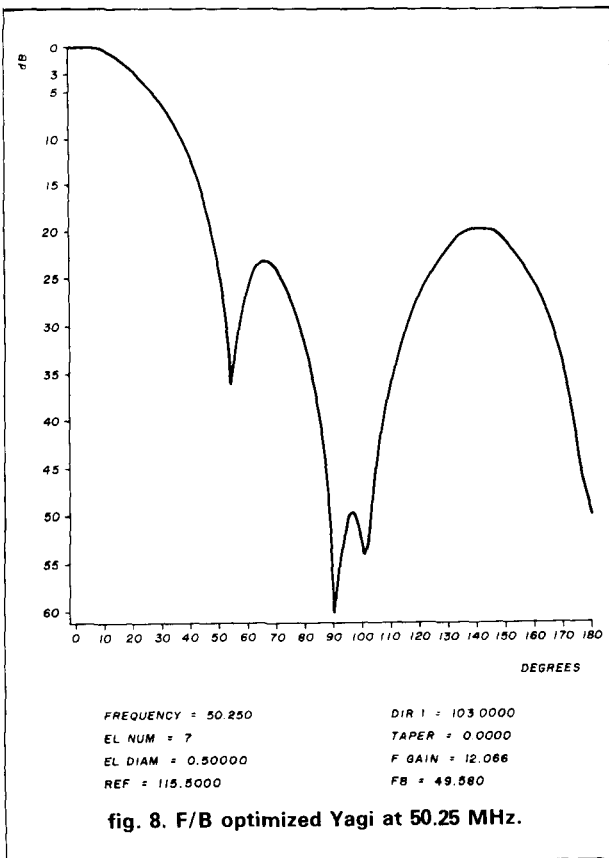
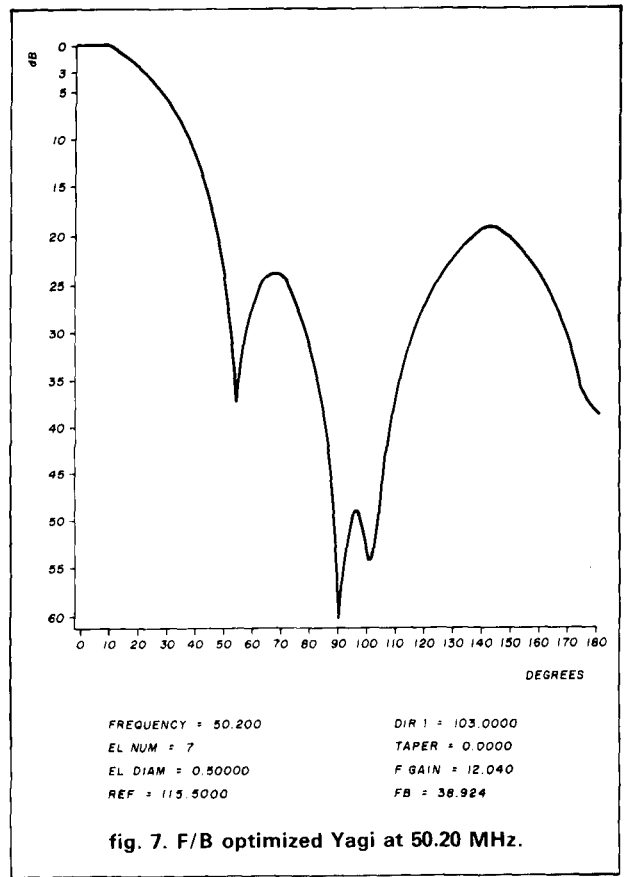
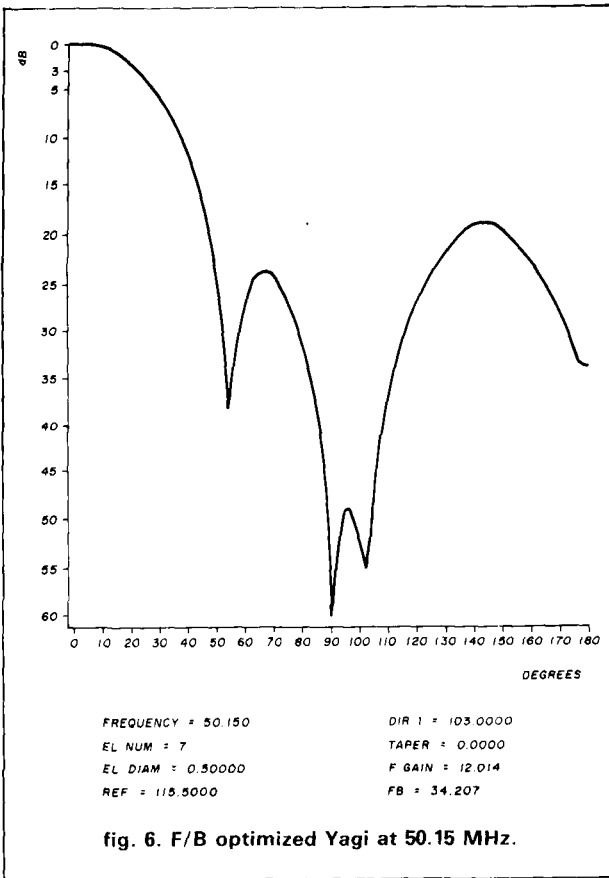

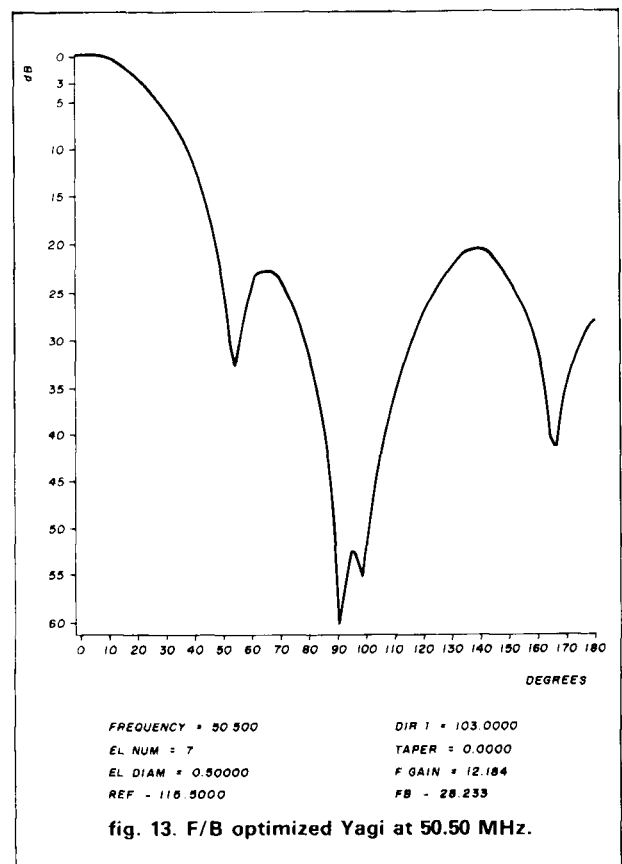
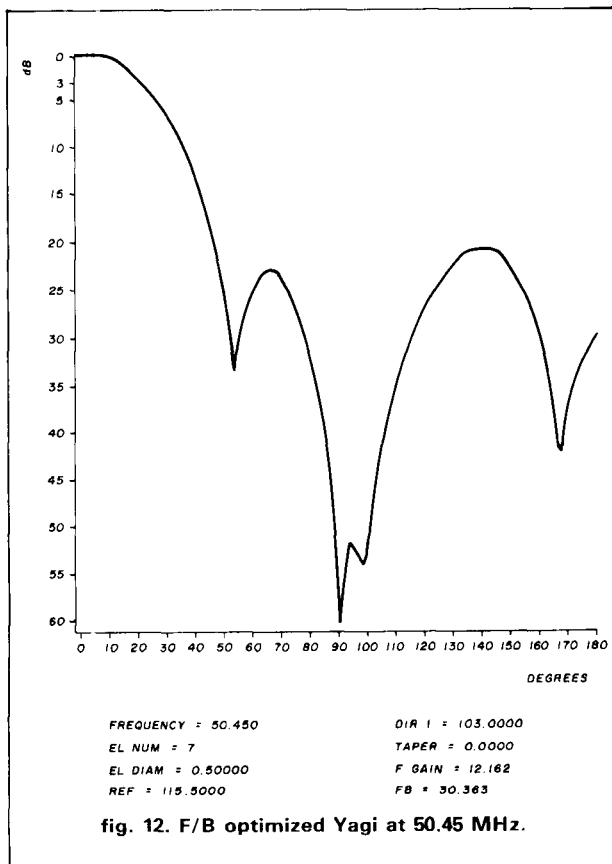
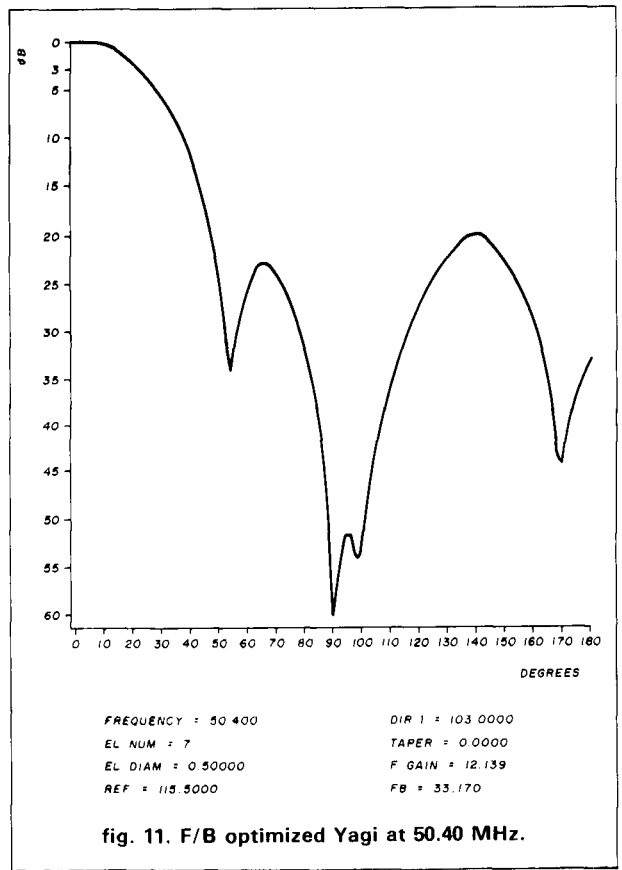
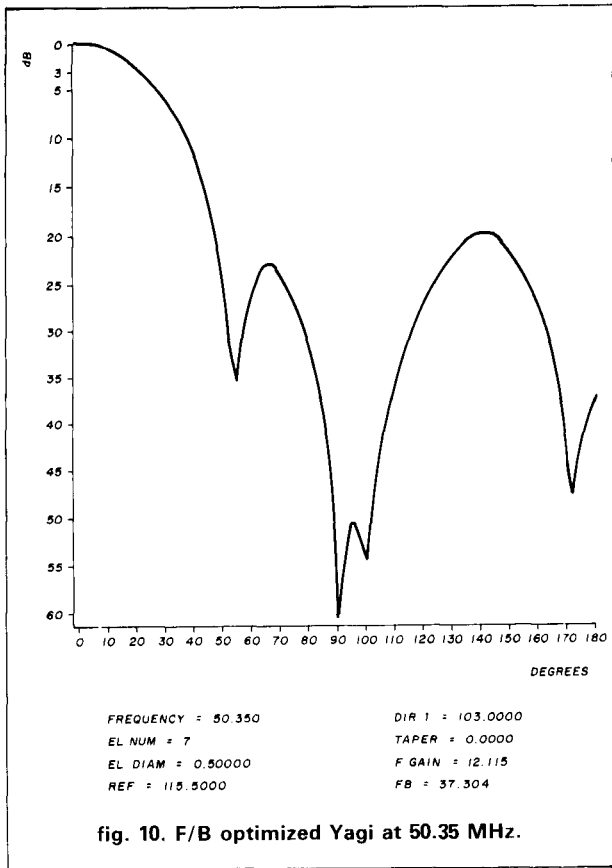

## WHAT'S REALLY HAPPENING IN HOME SATELLITE TV?

# STV SATELLITE TELEVISION MAGAZINE

A monthly of 100-plus pages, has all you need to know about where to find equipment, how it performs, how to install it, legal viewpoint, & industry insights.

- \$24.95 per yr. (12 monthly issues)
- \$ 2.00 for Sample Issue

MONEY BACK GUARANTEE if not satisfied (subscription orders only). Keep first issue with our compliments.

If you already have a dish, then you need

# OnSat™

—the best in satellite TV programming.

- ★ Weekly Updated Listings
- ★ All Scheduled Channels
- ★ Complete Movie Listing
- ★ All Sports Specials
- ★ Prime Time Highlights

- \$39.00 per yr. (52 weekly issues)
- \$ 1.00 for Sample Copy

Visa® MasterCard® accepted (subscription orders only). All prices in US funds only. Write for foreign rates.

Send this ad along with your order to:

**STV™/OnSat™**  
P.O. Box 2384 - Dept. PS  
Shelby, NC 28151-2384  
Subscription calls only  
Toll Free **1-800-438-2020**

table 7. Detailed performance parameters for the F/B optimized Yagi with a 0.000 taper.

frequency (MHz)	gain (dBi)	F/B (dB)
50.00	11.933	27.145
50.05	11.961	28.924
50.10	11.988	31.168
50.15	12.014	34.207
50.20	12.040	38.924
50.25	12.066	49.580
50.30	12.091	45.266
50.35	12.115	37.304
50.40	12.139	33.170
50.45	12.162	30.363
50.50	12.184	28.233

longer, these Yagis provide far more additional gain than this miniscule difference in boom length can explain. The model calculates 11.80 dBi gain for the NBS Yagi, as compared to 12.493 dBi for the gain optimized Tilton antenna, and 12.066 dBi for the F/B optimized Tilton antenna.<sup>8</sup> With approximately 19 dB of F/B, the NBS Yagi is superior to the gain optimized Tilton Yagi, but falls far short of the F/B optimized Tilton Yagi.<sup>9</sup> It should be noted that F/B was never a design criterion for any of the NBS Yagis. In conclusion it can be stated that as a result of the calculated performances of either of these two Tilton/Greenblum Yagis, either is preferable to the 1.2 wavelength NBS Yagi. The F/B optimized Yagi is the more preferable of the pair. The additional director on what is substantially the same boom length, provides a significant increase in performance.

Next month's installment addresses the general subject of Yagi performance optimization. In addition to discussing approaches taken by authors in the engineering literature, specific examples of techniques from the Amateur Radio literature will be modeled and iterated.

### references

1. James Lawson, W2PV, "Yagi Antennas: Practical Designs," *ham radio*, December, 1980, pages 33-35.
2. James Lawson, W2PV, "Yagi Antennas: Practical Designs," *ham radio*, December, 1980, pages 36-37.
3. James Lawson, W2PV, "Yagi Antenna Design: More Data on the Performance of Multi-element Simplistic Beams," *ham radio*, June, 1980, pages 33-40.
4. Edward Tilton, W1HDQ, "Six Elements on Six," *QST*, October, 1957, pages 18-20, 172.
5. Edward Tilton, W1HDQ, *The Radio Amateur's VHF Manual*, third edition, American Radio Relay League, Newington, Connecticut, 1972, pages 208-211.
6. Gerald Hall, K1TD, editor, *The Radio Amateur's Handbook*, American Radio Relay League, Newington, Connecticut, 1984, page 21-5.
7. Stanley Jaffin, WB3BGU, "Applied Yagi Antenna Design Part 2: 220 MHz and the Greenblum Design Data," *ham radio*, June, 1984, pages 33-46.
8. James Lawson, W2PV, "Yagi Antenna Design: Experiments Confirm Computer Analysis," *ham radio*, February, 1980, page 24.
9. Peter Viezbicke, "Yagi Antenna Design," *NBS Technical Note 688*, U.S. Department of Commerce, Washington, D.C., 1976, page 13.

**ham radio**



# The small dish that captures all the entertainment.

 **WILSON  
MICROWAVE  
SYSTEMS, INC.**



Only Wilson Microwave Systems can give you the versatility of hand-held control of the total satellite television spectrum at such a remarkably low price.

## **Total System Design.**

From the solid steel antenna to the state-of-the-art electronic receiver and hand-held control unit, Wilson gives you the most complete, integrated system you can own.

*At Wilson Microwave Systems, we put the world of entertainment in the palm of your hand.*



**BUILT BY YAESU**

**1 year warranty on receivers**

**4 year limited warranty on dish**

**NOW ONLY**

**\$1695.00** F.O.B. Nampa, ID

Includes: 110° LNA - Polarizer I - 100' Cable  
Wilson MD9 Dish - YM1000 Receiver

**Dealerships  
Available**

Antenna is shown with optional LNA cover.

**Distributed by**

# **NAMPA SATELLITE SYSTEMS**

312 12th Avenue South • Nampa, Idaho 83651

(208) 466-6727

In State Wats 1-800-654-1319 • Out of State Wats 1-800-654-0795

Attention HFer's — Don't skip Joe's column this month. The principles he discusses apply to other frequency ranges as well. — Editor

# VHF/UHF WORLD

Joe Reiser  
W1JR

## the VHF/UHF primer: an introduction to filters

Filters seem to be one of the least understood subjects in Amateur Radio despite the fact that numerous articles have been written on the subject. Have you ever heard an Amateur say, "I have this great 2-meter filter with only a 1-MHz bandwidth" (while failing to note or be aware of the fact that the insertion loss of the filter is 3 dB) or worse, say "I have this 70-cm (432 MHz) filter with only 0.15 dB loss," forgetting to mention that the bandwidth of the filter is 100 MHz!

Although most Amateurs seem to understand the difference between the categories of filters, described later in this column, they seldom understand how filters work. Sometimes they fail to recognize the interrelationship between bandwidth, insertion loss, and out-of-band attenuation, and what the best design for an application may be or how one goes about designing and building a filter. Although space doesn't permit presentation of a detailed design compendium, some designs and guidance will be provided in this and future columns.

## filter basics

Filters can be classified according to two general types: absorptive and reflective, with absorptive filters the less common type. Absorptive filters accept all frequencies received. The desired frequency or frequencies are passed through to the output, while the undesired frequencies are directed to either a built-in or external load where they are dissipated. An example of an absorptive filter is the diplexer for terminating a double balanced mixer recommended in a previous column.<sup>1</sup> The better homebrew TVI low-pass filters are absorptive filters.<sup>2</sup> The advantage of this type of filter is that the source or transmitter always sees a good VSWR almost regardless of frequency, harmonics, etc.; its disadvantages lie in the fact that the filter is usually twice as complex and requires an extra termination.

The most common type of filter is the reflective type, which allows the desired signals to pass through from the input or source to the output, but reflects the undesired frequencies back to the source. A good analogy to this type of filter is the typical Amateur Radio antenna system. The resonant (or bandpass) frequency of the antenna has, if properly matched, a low

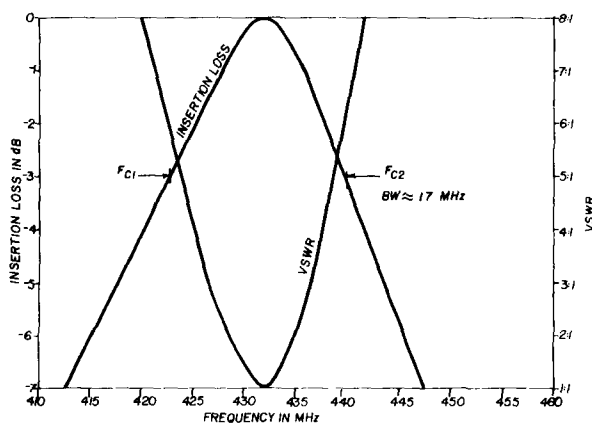

fig. 1. Insertion loss and VSWR of a 70-cm cavity filter.

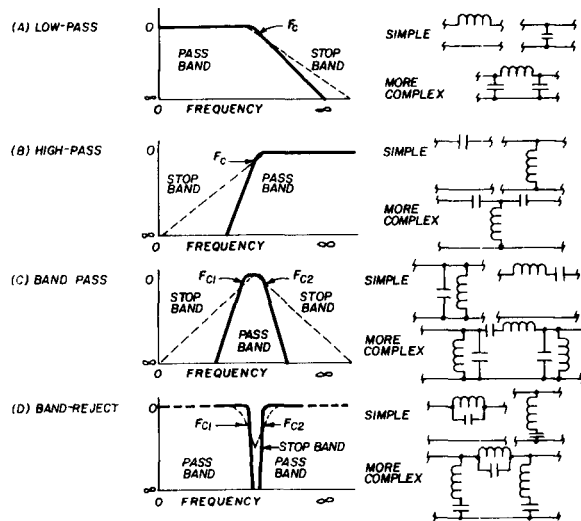

fig. 2. Basic categories of reflecting type filters in the frequency domain, illustrating typical simple and more complex circuits as well as frequency responses. Dotted responses represent simple filters, while solid lines indicate more complex filters.

VSWR, and radiates power into space. Frequencies off resonance are usually reflected back to the transmitter in the form of a high VSWR.

Fig. 1 illustrates this characteristic. A typical frequency versus input to output amplitude response and VSWR for a 70-cm reflective type bandpass filter is shown.<sup>3</sup> Note that the insertion loss, as expected, increases on either side of the center frequency,  $F_0$ . Note, too, that the VSWR rapidly increases on either side of  $F_0$  in a similar manner, and is approximately 6:1 at the half power or 3 dB down cutoff frequencies,  $F_{c1}$  and  $F_{c2}$ .

### filter categories

Within each of the two filter types, absorptive and reflective, there are four basic categories: low-pass, high-pass, bandpass, and band reject or band stop. Each has a specific passband in which the insertion loss is low and a cutoff frequency (or frequencies) where the output is one half or 3 dB lower than the power in the desired passband. Sometimes filters consist of a combination of two or more of these categories. For instance, a low-pass and a high-pass filter may be connected in cascade to form a bandpass filter.

Low-pass filters have low loss up to

the cutoff frequency and high insertion loss above this frequency (fig. 2A). They are most often used on the output of oscillators and transmitters to prevent harmonics from being radiated. (Typical low-pass filter schematics are also shown.) As the number of elements in the filter is increased, the passband insertion loss and the stop band attenuation increase. Also the passband insertion loss approaching cutoff is less as shown.

High-pass filters have high insertion loss below and low loss above the cutoff frequency (fig. 2B). They are most often used to prevent lower frequency transmitters from saturating the front end of a receiver. A common application involves using the filter on TV set inputs to prevent fundamental overload and on the input of an HF receiver to prevent overload from high power broadcast band transmitters. As the number of elements in the filter increases, the passband insertion loss and the stop band rejection increase, while the passband insertion loss approaching the cutoff frequency is less as shown in fig. 2B.

Bandpass filters have low insertion loss between two cutoff frequencies and high loss above and below the cutoff frequencies (fig. 2C). They are

probably the most common form of filter used by VHF/UHF Radio Amateurs and can be considered as a combination of a low-pass and a high-pass filter. They are most often used as front-end filters to reject out-of-band signals that may overload a receiver. As the number of sections increases, the passband insertion loss and the stop band rejection increase, but the passband insertion loss is also less as you approach the cutoff frequency.

Band reject or band-stop filters have high insertion loss at a specific frequency or band of frequencies but low loss on all other frequencies (fig. 2D). They are used to eliminate discrete frequencies such as an IF image, a birdie, or local transmitter. For increased rejection, the number of sections must be increased.

### filter parameters

The most important filter parameters are usually bandwidth and insertion loss. Secondary considerations are VSWR, passband ripple, out-of-band rejection, and shape factor. These parameters are all interrelated.

Insertion loss is especially important when a filter is at the input of a low-noise receiver because filter insertion loss at this location increases the noise figure by the same amount. If a filter follows a transmitter, the output power will be reduced by the amount of the insertion loss and if the filter is too lossy, it may break down or be destroyed when subjected to high power. Generally speaking, insertion loss increases if either the filter bandwidth is decreased, the number of sections in the filter is increased or the unloaded  $Q$ ,  $Q_u$ , of the inductors is low (more on this later in this column).

Bandwidth is very important because it defines the operational frequency range over which signals will not be attenuated more than 3 dB. Bandwidth should never be any less than necessary, since narrow bandwidth usually goes hand-in-hand with higher passband insertion loss and more critical tuning.

VSWR is usually low at the center

frequency of a well designed and built reflective type bandpass filter and climbs abruptly near the cutoff frequency going toward infinity in the rejection band (fig. 1). VSWR will also be low in the passband of other categories of filters (to be discussed later in this article) but will increase abruptly as the cutoff frequency is approached. If a low VSWR is desired over a wide band, either the bandwidth of the filter must be increased or additional filter sections added.

Passband ripple is a function of the design parameters, the insertion loss and how well the filter is tuned and built. Remember that at each point where there is ripple, the input VSWR will increase or decrease accordingly. Ripple is associated with certain classes of filters as shall be discussed shortly.

Out-of-band rejection is a function of the design parameters, the bandwidth, the types of components used in the filter, construction, and alignment; but most importantly, it is primarily determined by the number of elements or tuned sections in the filter. If a low out-of-band rejection filter is used, it could mean overload to a low-noise receiver or harmonics radiation from a transmitter. Sometimes the bandwidth cannot be sufficiently reduced, and the number of sections in the filter must be increased to adequately attenuate out-of-band signals. As mentioned earlier, when the number of sections in the filter is increased, so is the insertion loss. Consequently, to increase out-of-band rejection, the filter complexity will usually increase.

Similarly, the shape factor of a filter is a direct function of the number of elements or tuned sections in a filter as well as the design parameters. VHF/UHF filters usually do not approach rectangular shape factors like IF filters because losses and the complexity of the filter would be difficult to work with at these frequencies. Hence, if good shape factor is required, the desired frequency range is usually converted to a lower frequency where insertion loss and components do not provide such a constraint.

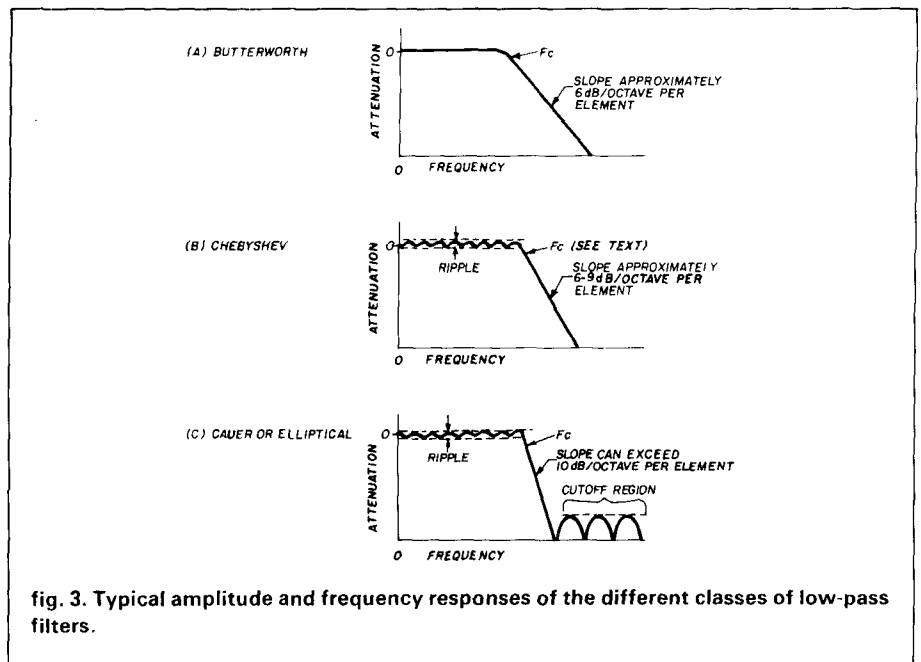

fig. 3. Typical amplitude and frequency responses of the different classes of low-pass filters.

### filter classes

Frequency domain filters are the most commonly used "LC" filters. The three classes most often used are the Butterworth (or maximally flat), the Chebyshev, and the Caer (or elliptical function). Each has specific characteristics defined by the design equations used to determine the component values and the tuning of the filter.

The most common filter, the Butterworth, or maximally flat filter, has been around for a long time. Its main advantages are that it has low insertion loss, low VSWR, a flat passband response and standard design tables are available.<sup>4-7</sup> Designs using normalized tables from these references are based on the 3 dB cutoff frequency. The disadvantage of the Butterworth filter is that its attenuation is only moderate out-of-band. A typical low-pass Butterworth filter response is shown in fig. 3A. Note that the attenuation in the stop band increases approximately 6 dB per octave (2 times the frequency) per filter element.

Chebyshev filters are a result of the development of modern filter theory. They are most often used when steeper stop band attenuation (than Butterworths can provide) is required. For example, the stop band attenuation for

a properly designed Chebyshev filter may increase (depending on passband ripple selected) to approximately 9 dB per octave per element, up to 3 dB more than a Butterworth design. The principal drawback of a Chebyshev filter design is that it has ripples in the passband. The greater the desired attenuation out-of-band per number of elements in the filter, the more the ripple in band. As a point of interest, when the passband ripple goes to 0 dB, the design goes from Chebyshev to Butterworth. Design tables in references 4, 5, 6, and 7 are available. Beware, however; some authors specify the cutoff frequency as the 3 dB down bandwidth,<sup>5</sup> while others specify the cutoff frequency as the limit where the ripple bandwidth is constant.<sup>6,7</sup> A typical Chebyshev low-pass filter frequency response is shown in fig. 3B.

Cauer, or elliptical function filters, are also a result of the development of modern filter theory. Similar to the Chebyshev, they have resonant circuits that are used to produce notches in the stopband and are most often used when very steep attenuation is required just outside of the passband, particularly when you want to notch a specific frequency or frequencies. Other applications include designs that require only a finite amount of stop

# John J. Meshna Jr., Inc.

19 Allerton Street • Lvnn, MA 01904 • Tel: (617) 595-2275

## DUAL FLOPPY DISC DRIVES

BRAND NEW, dual floppy disc drives made for Digital Equipment Corp. (DEC model no. RX 180 AB). This beautiful piece of computer hardware consists of 2 Shugart compatible TEAC 40 track, double density, 5¼" mini-floppy disc drives brand new in the case with their own regulated, switching power supply, cooling fan & on/off switch. Each unit also comes with a line cord & documentation. These were made for DEC, but are also compatible with other personal computers such as IBM, TRS 80 models I, II, & the Color Computer, and other Shugart compatible interfaces. Naturally you supply the cables and disc controller card to suit your particular system. The RX 180 AB runs off of 115/230 VAC 50/60 Hz. w/out any modifications to the drives. Each system comes in the original factory box and are guaranteed functional. A blockbuster of a buy !! Shpg. wt. 20 lb. Stock no. RX 180 AB \$250.00

Modified to run with TI 99/4A personal computer system \$285.00

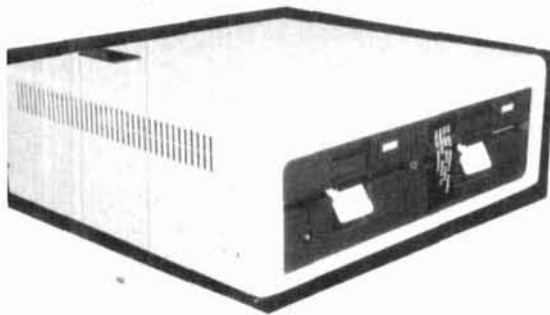

## HIGH SPEED KSR PRINTER TERMINAL

World famous, high speed G. E. Terminet 1200 RS 232 KSR printer terminals are now in stock ready for shipment to you. This has to be one of the finest letter quality printers ever offered at a bargain price. These terminals can be used as an RS 232 asynchronous communications terminal or used in the local mode as a typewriter. The terminals were removed from service for upgrading. Highlights of these machines are: Standard RS 232, full duplex, asynchronous data comm., fully formed upper and lower case letters, 128 character ASCII set, selectable baud rates of 110, 300, or 1200 BPS, 80 columns on pin feed paper, and less weight & size than an ASR 35 teletype with far less racket. They are virtually electronically foolproof as every pc board is Pico fuse protected. Should your machine not work, just check the on board fuses & out of 10 times that is where the problem lies. Schematics are provided w/ each machine sold. Current price of this machine new is over \$2000.00 ! Our meager price for this fantastic printer is only 10% of this: \$200.00 each!!! Visually inspected prior to shipment to insure completeness. Shpd, truck freight collect. \$200.00



## IBM 745 SELECTRIC BASED TYPEWRITER PRINTERS

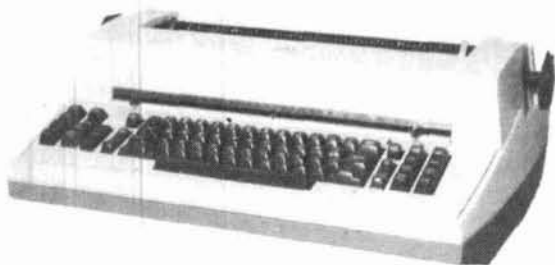

Send S.A.S.E. for free data sheet

These rugged, handsome printers were made for one of the giants of the computer industry. They can be used as a standard typewriter or as a printer in a word processing system for true letter quality printing. Solenoids were added to the selectric mechanism which disabled the manual repeat function but still allows electronic repeat functions. It uses standard IBM typing balls. The voltage requirements are standard 115 VAC, 5 VDC at 100 ma, and 24 VDC at 4 amps. All are new in factory boxes, but may require adjustments. We provide literature and schematics with 1 ribbon and cleaning tools. With the addition of our Centronics to Selectric I/O adapter, you could easily interface this printer to almost any micro computer system. Typewriter Printer stock no. RE 1000 A \$375.00, 745 manual \$30.00 Shpg wt approx. 80 Lbs, shpd by truck, collect.

### CENTRONICS TO SELECTRIC INTERFACE

This interface will adapt a Redatron Selectric I/O typewriter mechanism to be used as a parallel ASCII compatible printer. The parallel input port provides compatibility to Centronics standards for both "busy" and "acknowledge" protocols. The interface requires only +5 VDC at 350 ma. This interface is fully built, less power supply, is guaranteed operational, and comes with data. Shpg wt. 15 lbs DE 201 A, \$245.00

## 19" HI-RESOLUTION COLOR X-Y DISPLAY

Thru a special purchase we got hold of 50 brand new 19" color displays. They were made by Wells Gardner for one of the largest arcade video game manufacturers in the world. The displays feature built in red, green and blue amplifiers, 19" color tube made by Wells Gardner. User supplied external horizontal and vertical scan oscillators which allows precise user control over screen resolution. A real plus! Requires 25 V - 0 - 25 V input for amps, available separately. Some spec \$ for you technical people: signal inputs "X" horizontal 16 V P-P ±8 V, "Y" vertical 12 V P-P ±6 V; "Z" beam drive, 4 V max brightness, 1.0 Volt black level. Writing rates "X" amp is .05 inch/usec, "Y" amp is .0375 inch/usec. Great for making your own video games, oscilloscope monitors, or adapting for home computer use. Supplied with schematics. Shpg. Wt. 45 Lbs. MOT-19C \$199.00

TRANSFORMER FOR ABOVE Shpg. Wt. 15 Lbs. \$12.00

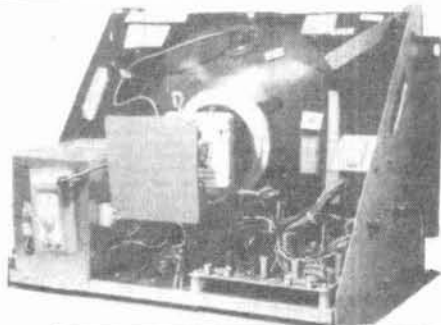

Phone Orders accepted on MC, VISA, or AMEX Surplus Electronic Material  
No COD's. Tel. 1-617-595-2275

Send for our free 72 page catalogue jam packed with goodies.



band attenuation. The passband ripple is similar to Chebyshev designs. However, in the stop band, they also have ripple and reach only a minimum level of out-of-band rejection determined by the design parameters and filter alignment. Elliptical function filters also require extra tuning elements and possibly some peculiar component values. Hence, they are usually only used at audio through HF. A typical low-pass elliptical function filter response is shown in **fig. 3C**.

### physical characteristics

Filters are made in many shapes and sizes. As discussed earlier, when the desired stop band rejection increases, the number of components and sections in the filter must increase. At lower frequencies (audio and HF), discrete components such as disc capacitors and inductors are usually used. However, as the frequency increases into the VHF/UHF range, other types of components such as air variables and rods for inductors are used. Also, at VHF/UHF, filters may take on other physical structures such as cavity, microstrip, stripline, combine, interdigital, or helical.

A **cavity filter**, especially the quarter-wave type (**fig. 4A**) is quite common at UHF, is basically an enclosure, usually a cylinder, with a rod typically close to a quarter-wave in length down the center of the enclosure that takes the place of a discrete inductor. By making the rod shorter or longer, it can be resonated, if desired, without a tuning capacitor. This is often referred to in the microwave community as the TEM (Transverse Electromagnetic) mode. However, the rod is often shortened slightly and tuned with a capacitor, typically two metal plates whose spacing can be varied, at the top of the rod to facilitate "tweaking" the filter to frequency. Cavities have low loss if they are large in diameter (between  $0.05$  and  $0.33 \lambda$ ), close to 77 ohms in impedance (3.6:1 ratio between the inside diameter of cavity and the outside diameter of the rod), have good conductivity particularly at the high current point at the base of the

rod, and especially if they are silver plated internally.

However most people ignore or are not aware of the fact that a quarter-wave cavity filter is also resonant at several other frequencies in addition to the design frequency. If the filter is tuned mainly by adjusting the length of the rod, the other resonances will be close to 3, 5, 7 (etc.) times the design frequency. Hence they are not good harmonic filters! These other resonances can be pushed higher and placed above the harmonic by shortening the quarter-wave rod and using capacitance tuning as just described. The shorter the rod, the higher the frequency of the other resonances.

Another favorite Amateur filter configuration is the "half-wave" type (**fig. 4B**). Basically composed of two quarter-wave filters in tandem, its chief advantages are its requirement of only one tuning capacitor and its very symmetrical out-of-band rejection (more on this later in this article). The inductor can even take the form of a flat strip, thus yielding a mechanical advantage in some situations, since the input and output are at different ends of the filter.

**Interdigital filters** are very common especially at UHF and above.<sup>7-9</sup> They get their name from their physical appearance — they look like fingers joined (or interdigitated) together (**fig. 4C**). The rods are nearly a quarter-wave long, and ground is alternated from side to side. The spacing between resonators, the rod diameters, and the thickness of the structure are the major factors in determining bandwidth. Because the open ends have some fringing capacitance, it is best to shorten the rods slightly and add a small tweaker such as a silver-plated screw. This type of filter, properly constructed, usually has low passband insertion loss and is easily duplicated. It is readily scaled in frequency by keeping the thickness, rod diameter, and spacing constant, and just changing the length. The new frequency will have the same percentage bandwidth as the original frequency. This type of

filter is usually large and also suffers from the overtone problems as mentioned above with the quarter-wave cavity type filter.

**Combine filters** — so named because they look like the teeth of a metal comb — are very common in the industry, (**fig. 4D**). Their rods or resonators are usually about one-eighth wave long (in contrast to the quarter-wave interdigital type). These filters are usually used where space is at a premium. Frequently the resonators are close together, and partitions or walls are placed between them, with the height of the partitions determining the coupling and hence overall filter bandwidth. The advantage of this type of filter configuration is that if the resonators are kept short, the response to overtones (as discussed above) will be much higher in frequency and may not be detrimental, as in the case of the interdigital type. One advantage or disadvantage, depending on your point of view, is that tuning capacitors are required.

**Microstrip and stripline** techniques are often used, especially when designing combine and interdigital filters. The spacings and impedances are set for the desired filter response. Losses in this type of construction are frequently higher than those using resonators etc. but this type of structure is usually reproducible.

Let us not forget **helical resonator filters**,<sup>10,11</sup> which resemble a large coil, usually with large diameter wire wound like a helix antenna (**fig. 4E**). Placed in a structure similar to the cavity filter, a helical resonator filter is usually used when relatively high inductance and low passband insertion loss are required, especially on the VHF and lower UHF frequencies.

### filter anomalies

Several things must be understood before filter design can begin. It is assumed at the outset that all formulas used and the computed values are correct; the principal filter design problems occur with the values of the components and the types of component selected. Components are usually

chosen using standard design equations or normalized tables.<sup>4-7,12</sup> It would be very difficult to build a filter if the component values were not standard or readily available. Therefore, it is usually preferable to make some of the components variable, especially in bandpass filters. I prefer to use variable capacitors instead of variable inductors because they usually have higher  $Q_u$  and are easier to tune.

If insertion loss is important, and/or if the bandwidth of the filter is narrow, the components chosen must have high  $Q_u$  at the filter frequency. Air variables or small tuners made from plated screws are usually preferred at VHF/UHF frequencies. Inductance in series with the capacitor may cause loss or distortion such as a decrease in attenuation at some frequency or frequencies in the rejection band.

However, the greatest filter loss usually occurs in the inductors. The  $Q_u$  of an inductor should be as high as possible. For reference, I have shown some typical values of  $Q_u$  in **table 1**. This table is by no means complete, but can be used as a guide. Note that most discrete inductors have only moderate  $Q_u$  while cavities and helicals are high.

To determine the loss of an inductor in a bandpass filter, it is first necessary to determine the loaded  $Q$ , " $Q_\ell$ " of the filter as follows:

$$Q_\ell = \frac{F_o}{F_{c2} - F_{c1}} \quad (1)$$

where  $F_o$  is the center frequency,  $F_{c1}$  is the lower cutoff ( $-3$  dB) frequency and  $F_{c2}$  is the upper cutoff frequency all in the same units. For example, the filter in **fig. 1** has a center frequency of 432 MHz and upper and lower cutoff frequencies of approximately 440 and 423 MHz respectively. Therefore:

$$Q_\ell = \frac{432}{(440 - 423)} = 25.4$$

The loss in a filter is directly related to the ratio of the  $Q_u$  and  $Q_\ell$  of the filter as shown in **eq. 2**:

$$\text{insertion loss (dB)} = 10 \log_{10} (1 - Q_\ell / Q_u)^2 \quad (2)$$

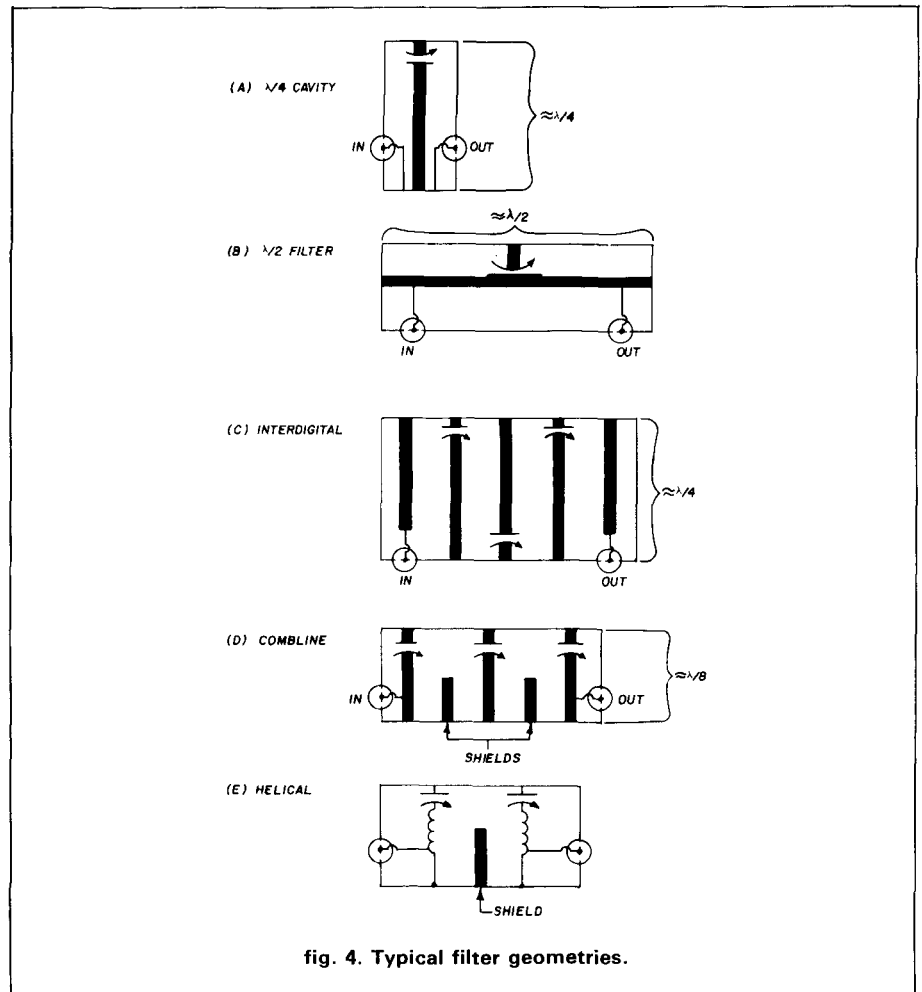

fig. 4. Typical filter geometries.

table 1. Typical  $Q_u$  versus frequency for some commonly used inductors.

inductor type	frequency range (MHz)	typical unloaded Q
toroid	1- 100	50- 200
0.25" (6.35 mm) diameter coil	50- 500	300- 400
0.5" (12.7 mm) diameter coil	50- 300	400- 500
microstrip (on G-10 PC board)	400-2300	175- 420
microstrip (on PTFE fiberglass)	400-2300	200- 775
1" (25.4 mm) diameter 77-ohm cavity	300-1000	500-1000
3" (76.2 mm) diameter 77-ohm cavity	100- 500	1000-1500
1" (25.4 mm) helical resonator	100- 500	500-1000

For the sake of simplicity, I have drawn a graph for the most common ratios of  $Q_u/Q_\ell$  in **fig. 5**. If the same example is used from **fig. 1**, and the  $Q_u$  of the inductor is approximately 1000 (from **table 1**), the  $Q_u/Q_\ell$  ratio is 39.37, and the insertion loss of this filter will be approximately 0.22 dB. Now if the inductor had a  $Q_u$  of only 300,

the  $Q_u/Q_\ell$  ratio would be 11.8, and the loss would rise to approximately 0.77 dB — a huge increase! *This example shows why cavities are preferred at VHF/UHF frequencies.*

Before leaving this subject, it might be wise to explain how insertion loss can be determined in a multi-section filter. Cohn provides an equation to

determine this loss.<sup>13</sup> I have simplified his formula and listed the values or "K" factor necessary to determine the loss for common two through seven-section Butterworth bandpass type filters. Other types of filters may have slightly higher insertion losses. To obtain the loss of a multi-section bandpass filter, use the following equation:

$$\text{total insertion loss (dB)} = K(Q_L / Q_U) \quad (3)$$

where  $K$  is the number from **table 2** for the number of sections in the filter and  $Q_L$  and  $Q_U$  are as determined above. For example, if the filter in **fig. 1** had 3 sections but the same  $Q_U$  (1000) and  $Q_L$  (25.4), the insertion loss would be approximately 0.441 dB, much greater than the single section. If the  $Q_U$  were only 300, the insertion loss would climb to 1.47 dB. Hence, you are trading insertion loss for better out-of-band rejection — not always a bad compromise!

Insertion loss has one other detrimental effect. Since the insertion loss

table 2. Approximate insertion loss in a multi-section Butterworth bandpass filter can be determined by using this information in conjunction with eq. 3.

number of sections	K factor
2	12.28
3	17.36
4	22.70
5	28.10
6	33.55
7	39.10

as you pass through the filter is cumulative, the amount of energy reaching each successive section in the filter is less. As a result, if the insertion loss of a filter is high, the bandwidth of the filter and its ripple characteristics may change from those predicted or calculated. Hence it is best to design a filter with slightly wider bandwidth than required because losses reduce bandwidth when the filter is finally tuned to frequency.

Other anomalies depend on the top-

ography chosen. For instance, if the coupling into and out of a bandpass filter is capacitive, the filter will acquire a high-pass characteristic in the rejection band. Inductive coupling, a low-pass characteristic, may also occur. A combination of the two will yield a more symmetrical rejection band. This is illustrated in **fig. 6**.

Finally, input or output VSWR due to component selection, tuning, or loading will cause increased insertion loss, asymmetry in the pass or reject band and/or ripple in the passband. In this regard, bandpass filters with single sections are preferred, especially when they are placed ahead of a low-noise preamplifier since the point of minimum insertion will usually fall at the center of the band. Hence, if there is a severe mismatch (typical of low-noise amplifiers) the chances are that the minimum ripple will remain at the center frequency. To a somewhat lesser degree, 3 or 5-section filters are also preferred over 2 and 4-section filters for the same reason.

## designing filters

Low and high-pass filter designs are available in references 4 through 7 and also in 12. Band reject or band stop filters, primarily used in duplexers for FM repeaters where very high attenuation is needed between two close frequencies<sup>14</sup> are documented in references 4 and 5. My favorite bandpass filter design procedures are found in Zverev's book (reference 5). Some selected Chebyshev bandpass filter designs can be found in Anderson's *ham radio* article of June, 1977.<sup>15</sup> Design programs for many of these filters are now available for computer-oriented<sup>16</sup> Amateurs.

**Bandpass filters** seem to be the most widely used by VHF/UHFers, especially in receivers, transmitters, and ahead of preamplifiers. Hence I have dedicated the major part of this column to that subject and direct you to the applicable reference for the other categories of filters because they are usually easier to design. However many of the suggestions in this column apply to filters of any category.

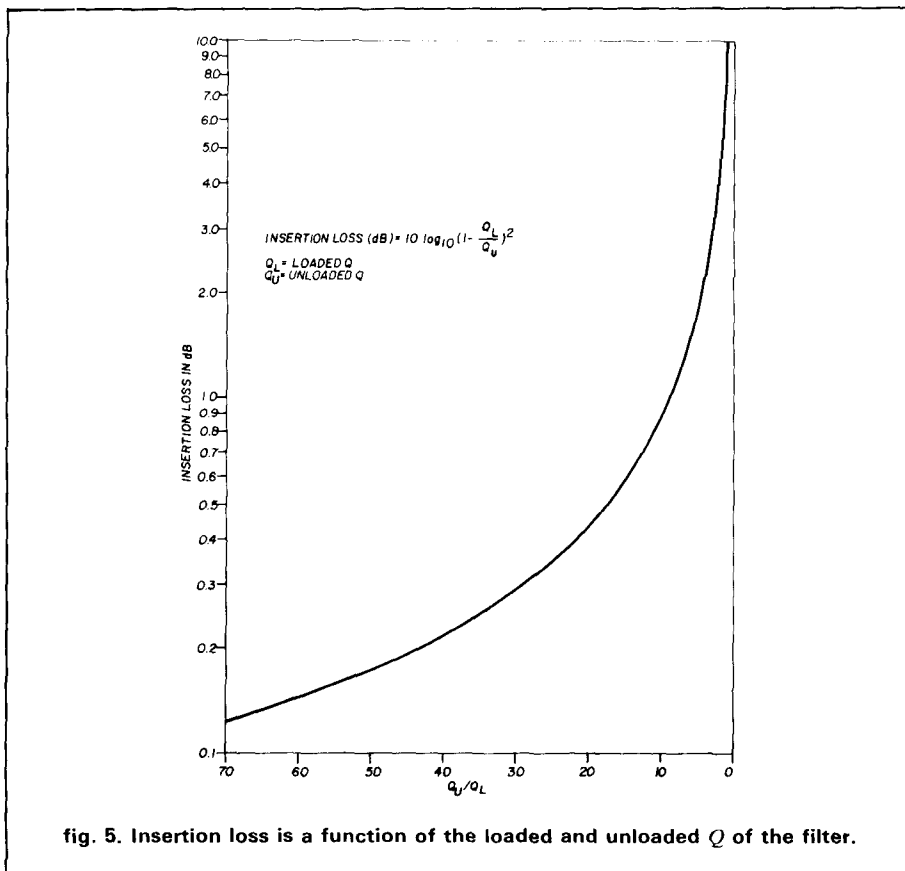

fig. 5. Insertion loss is a function of the loaded and unloaded  $Q$  of the filter.

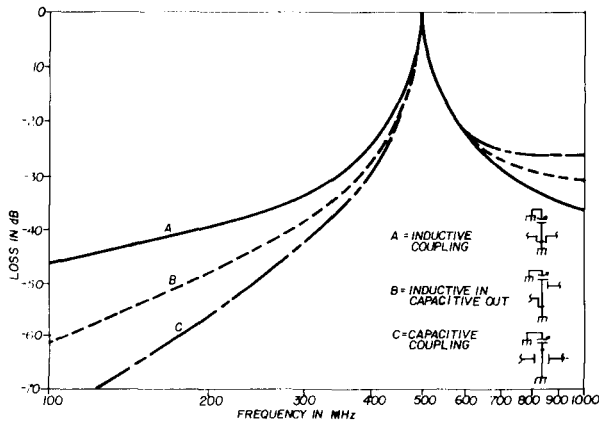

fig. 6. The frequency response of a 500-MHz cavity filter depends on coupling technique.

## adjusting and measuring performance

This is really a subject for a whole column in itself. Remembering what has been said so far, the simple single-section filters (such as quarter-wave cavity) can usually be adjusted to frequency simply by placing a good low VSWR 50-ohm termination on the output of the filter and tuning for minimum VSWR. Multi-section filters usually require some sort of sweep setup with detectors. A typical procedure is to first align the filter for approximately the amplitude response expected. Then the final testing and alignment is performed by observing  $\sqrt{\text{SWR}}$  over the entire bandwidth.

Dishal used a slightly different method, in which he adjusted a slotted line and successively either shorted or opened each section of the filter as it was adjusted.<sup>17</sup> Suffice it to say that the proper alignment of a multi-section filter requires both excellent test equipment and the skill to recognize what is taking place.

## summary

It is important to recognize the different electrical and physical properties in order to choose or understand what filter is the type required for a specific application before designing or building it. It is also nice to at least know the difference between a Butterworth, Chebyshev, or Cauer filter, and

whether it is a low-pass, high-pass, band stop or bandpass type. Hopefully this article has provided sufficient information to make this possible.

## acknowledgements

I would like to thank Ron Matthews and Keith Whynot, WA1GZN, for their helpful suggestions in preparing this month's column.

## references

1. Joe Reisert, W1JR, "VHF/UHF World: Receivers," *ham radio*, March, 1984, page 42.
2. Richard Weinreich, K0UVU, and R.W. Carroll, "Absorptive Filter for TV Harmonics," *QST*, November, 1968, page 20.
3. Joseph H. Reisert, Jr., W1JAA, "Ultra Low-Noise UHF Preamplifier," *ham radio*, March, 1975, page 8.
4. Philip R. Geffe, *Simplified Modern Filter Design*, Hayden Book Company, 1963.
5. Anatol I. Zverev, *Handbook of Filter Synthesis*, John Wiley and Sons, 1967.
6. L. Weinberg, *Network Analysis and Synthesis*, McGraw-Hill Book Company, 1962.
7. George L. Matthaei; Leo Young, and E.M.T. Jones, *Microwave Filters, Impedance-Matching Networks, and Coupling Structures*, McGraw-Hill Book Co., 1964.
8. Reed Fisher, W2CQH, "Interdigital Bandpass Filters for Amateur VHF/UHF Applications," *QST*, March, 1968, page 32.
9. William S. Metcalf, "Graphs Speed Design of Interdigital Filters," *Microwaves*, February, 1967, page 91.
10. James R. Fisk, W1DITY, "Helical-Resonator Design Techniques," *QST*, June, 1976, page 11.
11. Lee R. Watkins, "Need a Helical Filter?," *rd design*, May/June, 1981, page 44.
12. Edward E. Wetherhold, W3NQN, "Design of 7-Element Low-Pass Filters Using Standard-Value Capacitors," *EDN*, January, 1979, page 187.
13. Seymour B. Cohn, "Dissipation Loss in Multiple-Coupled-Resonator Filters," *Proceedings of the IRE*, August, 1959, page 1342.
14. John J. Bilodeau, W1GAN, "A Homemade Duplexer for 2-Meter Repeaters," *QST*, July, 1972, page 22.

15. Leonard H. Anderson, "Top-Coupled Bandpass Filter, a Chebyshev Design," *ham radio*, June, 1977, page 34.
16. "RF Computer-Aided-Design Package," *Heath User's Group*, 885-8020(-37) CP/M.
17. Milton Dishal, "Alignment and Adjustment of Synchronously Tuned Multiple-Resonant-Circuit Filters," *Proceedings of the IRE*, November, 1951, page 1448.

## important VHF/UHF events in August, 1984

- August 5-6: ARRL UHF Contest  
 August 11: 1945 UTC, predicted peak of Perseids meteor shower  
 August 28: Moon at perigee

ham radio

## short circuit digital audio filter

In *WIØER*'s "A Digital Audio Filter for CW and RTTY" (August, 1983, page 61), U4 and U5 should be labeled LF356N, not LF365N.

# AUSTIN. When only the best will do!

Taking the leading role in custom antenna design comes easily to Austin. With over 25 years of engineering and consulting experience, how could we offer you less than the best?

And our high performance solutions go beyond our popular MULTIBAND antennas.

There's THE OMNI sidebander with horizontal and vertical polarization. Or the ALL BAND SCANNER with high gain that outperforms the competition. And THE STICK, a broad band design for operation from Amateur to Marine frequencies. Just a sampling of the choices available.

Whatever your antenna needs, the winner is Austin.

Call or write for product information. Dealer inquiries invited.



**AUSTIN  
CUSTOM  
ANTENNA**

P.O. Box 357  
Sandown, NH 03873  
(603) 887-2926

116



# NEW products

## touch-tone decoder

Connect Systems, Inc., has introduced a new 16-function touch-tone decoder board. Designated model CS-16, the decoder will securely control virtually any apparatus via radio or wireline. The CS-16 is especially useful for controlling various repeater on/off functions.

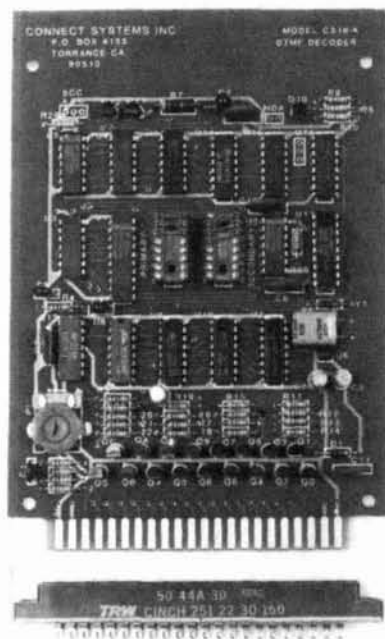

A unique feature of the CS-16 is dual password control. Two separately user-programmable three-digit passwords create hierarchy control capability. The primary control password can access all 16 of the available functions. The secondary password, however, can access only 8 of the 16 functions. A special primary password command, capable of enabling or disabling secondary password access, is available. The CS-16 provides such a high degree of multi-level security that control can be accomplished directly on voice channels, thus eliminating the need for separate control frequencies.

The CS-16 provides 16 independently controllable on/off latched functions. Each function is provided with an open collector and 5-volt CMOS logic output. A strobe output is also available in open collector and logic format. This output can be used to gate repeater audio so that DTMF control commands are not retransmitted.

A power-up reset feature causes all outputs

to be in the "off" state after application of power. An audio pre-amp with level control permits the crystal controlled tone decoder to operate over the wide input range of 10  $\mu$ V to 2 volts. A strobe LED lights when any of the 16 buttons on a pad is pressed. (The CS-16 can also be used with 12 button pads). An on-board voltage regulator permits operation with a 10-25 VDC power source. The CS-16 incorporates reverse polarity protection and draws less than 20 mA from the supply.

For more information, contact Connect Systems, Inc., 23731 Madison Street, Torrance, California 90505.

Circle #301 on Reader Service Card.

## extended warranty on satellite TV equipment

The R.L. Drake Company has announced that it has extended the limited warranty on the new Drake ESR-240 satellite earth station receiver and all other Drake satellite television equipment from one year on parts and 90 days on labor to one year for *both* parts and labor because no problems have been experienced with the new receiver's state-of-the-art infrared tuning feature.

For further information, contact R.L. Drake Company, 540 Richard Street, Miamisburg, Ohio 45342.

## two new mobiles from ICOM

ICOM has added two more transceivers to its line of ultra-compact mobiles: the IC-27H 45-watt 2-meter mobile and the IC-47A 25-watt 440 MHz mobile.

Standard features of the IC-27H include 45 watts output, compact size (1-5/8" high  $\times$  5-1/2" wide  $\times$  9-3/8" deep), a built-in internal speaker for easy mounting, nine full-function memories, 32 built-in PL frequencies, professional communications design and styling, and an IC-HM23 DTMF microphone with up/down buttons. Scanning functions include memory scan, band scan, and priority scan. An internal lithium memory battery backup maintains memories for up to five years.



The features of the IC-47A are similar to those of the IC-27H, with the exception of 25-watt operation and somewhat smaller size.

Both units include the IC-MB27 mobile mount. A variety of options, including an IC-UT16 speech synthesizer and IC-SP4 and SP5 external speakers, are available for both units. The IC-27H is priced at \$409; the IC-47A, at \$469.

For further details, contact ICOM America, Inc., 2112 116th Avenue, N.E., Bellevue, Washington 98004.

Circle #302 on Reader Service Card.

## desoldering pump

A compact spring-powered desoldering pump has been introduced by the Ungar Division of Eldon Industries, Inc.

The Ungar 7870 desoldering pump can be operated with one hand, leaving the other free to hold the soldering iron. A spring-loaded piston



is set with the thumb and released by pushbutton. The vacuum created by a piston stroke of less than two inches instantly removes molten solder. The thumb tap is recessed into the handle to prevent eye injury doing close-tolerance desoldering, and a plated interior rod cleans the tip each time the pump is used.

Further information is available from Ungar P.O. Box 6005, Compton, California 90220.

Circle #304 on Reader Service Card.

## new terminal

Robot's new 800C specialty mode terminal, an improved version of their Model 800 "super terminal," provides Amateur Radio operators a all-in-one package with display, storage, an automatic operation for the transmission and reception of RTTY and Morse code signals. A major feature of the 800 is its built-in demodulator, which uses separate active discriminator filters for the demodulation of the RTTY signal.

Key features of the new 800C terminal include a 1023 character transmit buffer, ten 64-character message memories with soft partitioning, a RS-232 serial and Centronics parallel printer interface, color SSTV graphics capability with eight graphics memories (when used with Robot's new color scan converters), and battery backup on all memories. These new features are also available in a retrofit kit for existing model 800C.

For more information, contact Robot Research, Inc., 7591 Convoy Court, San Diego, California 92111.

Circle #303 on Reader Service Card.





product

# REVIEW

## Mini Jini Record Keeper

Mini Jini Record Keeper from Jini Micro Systems is a powerful, yet easy-to-learn, plug-in data-base manager for both the VIC-20 and Commodore 64. (The term "data base" is synonymous with "file cabinet," updated to take advantage of the latest in computer technology.)

In the ham shack we store important information in a number of different and sometimes disorganized ways: in logbooks, cardboard boxes, and drawers. This can all add up to a disorganized and difficult-to-use system of data management.

Mini Jini was originally developed for the PET line of Commodore computers as the JinSam 8.2 Data Manager. This software has been used extensively throughout the business world because of its powerful record keeping capabilities and its easy-to-use design.

NASA, for example, has made extensive use of JinSam in its management of landing site facilities for the space shuttle program. Space shuttles have two main landing sites: one at Cape Canaveral in Florida and the other in California at Edwards Air Force Base. Because of the possibility of problems that might preclude landing at either of these sites, NASA has designated five additional sites around the world. In order to be ready to use any one of these, and to hold costs down, NASA's contingency plan specifies that in the event of an unscheduled landing at any alternate site, equipment would be shipped to the landing site from a central location. Obviously, manual file maintenance of such an elaborate system would be costly and cumbersome. Using their Commodore CBM and the JinSam 8.2, NASA's records now contain fields (i.e., files) for equipment nomenclature, serial number, and present location. In just a few minutes, NASA personnel can do full file searches to produce organized shipping lists of equipment for each or all landing sites.

Since the developers of the JinSam 8.2, Jim and Nancy Iscaro, are both hams, it was only a matter of time before they turned their attention to using JinSam for Amateur Radio purposes. Noting that both the Commodore 64 and VIC-20 are quite popular in the Amateur Radio field, the Iscaros set about the task of converting JinSam to a usable format for the C-64 and VIC-20. The result was Mini Jini. Of tremendous interest is that this program is not limited to Amateur Radio use, but can be used to store a variety of business, household, or personal information. For the Radio Amateur, Mini Jini can be used

to log QSOs, print QSL labels, inventory equipment, keep contest logs, organize magazine files, and catalog foreign phrases, to name just a few of its many uses.

Mini Jini comes in a manufactured board that is inserted into either the VIC-20 or C-64 cartridge slot. With a stock (unexpanded) VIC-20, you can store up to 50 full records of 250 characters each. With a 24K memory expander added, the VIC-20 can handle up to 500 records in memory. The C-64 will hold up to 750 records. For permanent file storage, it's necessary to add either a disk drive or cassette recorder.

The well written and informative instruction book makes data entry easy. Mini Jini's manual should answer just about any question you may have; it's also full of helpful hints and tips on how to get the most of Mini Jini's capabilities.

In the ham shack, computers are no longer a luxury. In fact, after seeing how many VIC-20 and Commodore owners responded to our reader survey (see September, 1983, for the survey, and January, 1984, for our editorial response), it's hard to imagine that there's *anyone* who doesn't have a computer to use! Record keeping with computers can be a real plus when you're contesting, QSLing, or organizing your collection of magazine articles. Mini Jini will do it for you with a minimum of fuss and hassle.

For more information, contact Jini Micro-Systems, Box 274 Kingsbridge Street, Riverdale, New York 10463.

Circle 1305 on Reader Service Card.

NIACH



## power and power supply

The Spectrum SCA100V is a new 150-watt repeater/base station amplifier that operates in the 136-174 MHz range. Its unique heatsink and high efficiency cooling system design allow cool operation even under continuous duty conditions in a hot environment. The "behind the panel" heatsink permits use in a locking front door cabinet without loss of cooling effectiveness. It also features automatic high-VSWR shutdown/"bypass" with 4X auto-reset circuit and automatic amp bypass (if the power supply should fail or if the amp should overheat), as well as unusually tight RF shielding and heavy-duty construction. A 100-watt UHF version is also available.

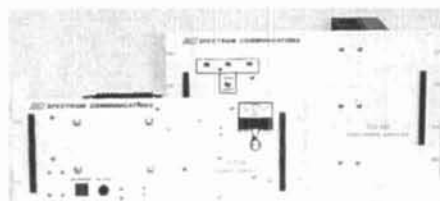

## new SIX BAND VERTICAL ANTENNA

Model AV-25  
NO TRAP VERTICAL  
for 80, 40, 30, 20, 15, 10  
meters.

\$99.50

UPS SHIPPING  
& HANDLING  
ADD \$11



- Only 25 ft. high.
- Three parallel vertical elements.
- Rugged steel tubing.
- Direct feed with 52 ohm coax, low SWR.
- Broad band.
- Capacity loaded, top and sides.
- Only one coil, high in 80 M element.
- Also available for commercial frequencies.

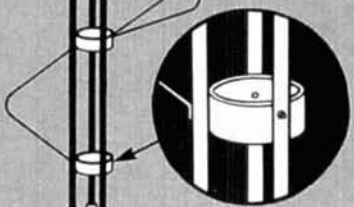

4 1/2" DIA.  
SPACERS

AR-25 Radial System for AV-25 antenna. Four multiwire radials that are resonant on each of the six bands. \$19.50

PATENT PENDING



ALL OUR PRODUCTS MADE IN USA

**BARKER & WILLIAMSON**

Quality Communication Products Since 1932

At your Distributors write or call

10 Canal Street, Bristol PA 19007

(215) 788-5581



# 1984 CALLBOOKS

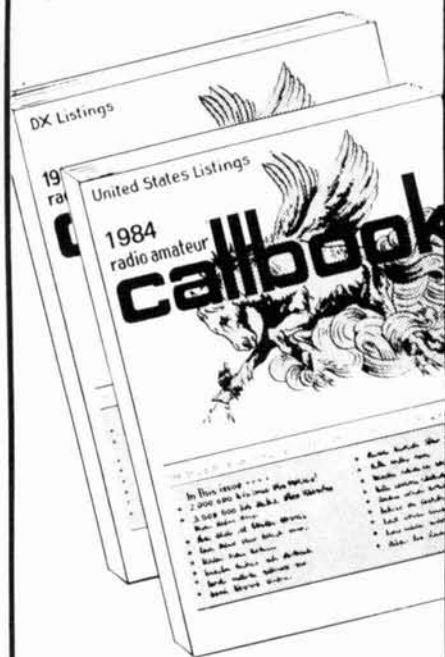

**Order today!**  
1984  
**RADIO AMATEUR CALLBOOKS**

Known throughout the world for accuracy, the 1984 Callbooks are a better value than ever before. The U.S. Callbook contains over 433,000 listings; the Foreign Callbook has over 413,000. More than 100,000 changes have been made in each edition since last year. Special features include call changes, Silent Keys, census of amateur licenses, world-wide QSL bureaus, international postal rates, prefixes of the world, and much more. You can't beat this value! Order your 1984 Callbooks now.

Each Shipping Total

□ U.S. Callbook	\$19.95	\$3.05	\$23.00
□ Foreign Callbook	18.95	3.05	22.00

Order both books at the same time for \$41.95 including shipping within the USA.

Order from your dealer or directly from the publisher. Foreign residents add \$4.55 for shipping. Illinois residents add 5% sales tax.

**Keep your 1984 Callbooks up to date.** The U.S. and Foreign Supplements contain all activity for the previous three months including new licenses. Available from the publisher in sets of three (March 1, June 1, and September 1) for only \$12.00 per set including shipping. Specify U.S. or Foreign Supplements when ordering. Illinois residents add 5% sales tax. Offer void after November 1, 1984.

RADIO AMATEUR **callbook** INC. ✓ 178



Dept. F  
925 Sherwood Dr., Box 247  
Lake Bluff, IL 60044, USA

Tel: (312) 234-6600



## EGBERT II+ RTTY - CW - XFER

for the Apple II, II+, IIe  
Transmit & Receive with Software Only  
**NO TV REQUIRED**

The Egbert II+ has RTTY/CW/XFER on the same disk! and features: split screen operation, type ahead buffer, selectable mark, space, shift and speed, change modes and speeds from menu, mailbox with selective call and save to disk. Provisions for up to 9 canned messages on each data disk, and much more.

FOR MORE INFO, OR ORDER, CALL OR WRITE:

**W.H. NAIL COMPANY**  
275 Lodgeview Drive  
Oroville, Ca. 95965  
(916) 589-2043

M/C VISA

Egbert II+ = \$69.95 includes program, back up & documentation. USA Residents add \$2.50 for shipping. All others add \$6.00. Ca. Res. add 6% sales tax. ✓ 169

**INCLUDE CALL SIGN WITH ORDER!**



The companion power supply for the SCA100V amplifier, the SCP30, may also be used for any type of high-power amplifier, service bench, or industrial application requiring very heavy duty supply. Its output is 13.6 VD at 25 amperes, continuous, 30 amperes intermittent.

For further details, contact Spectrum Communications Corp., 1055 West Germantown Parkway, Norristown, Pennsylvania 19401-961

Circle #306 on Reader Service Card.

### break-in adapter

Design Electronics Ohio has introduced its first break-in amplifier adapter, the QSK-1500. Designed to mate currently available full break-radios — such as all Ten-Tec units, the Kenwood TS930, Drake TR-5, the Yaesu FT1, FT980, and FT757, and the ICOM751 — to either commercial or homebrew linear amplifiers. Installation of the QSK-1500 requires no internal modifications to most transceivers or amplifiers; a minor modification is necessary with Ten-Tec units on SSB.

While the QSK-1500 was designed primarily with the CW operator in mind, it will also function on SSB and RTTY. High power Amortor now also possible with this unit.

The QSK-1500 uses ultra high speed PIN diode switching and has no clicking or annoying relay. The unit is designed to handle 1500 watts RF in a 50-ohm load at 40 WPM. Insertion loss is less than 0.6 dB on receive. Maximum receiver line voltage is 3800 mV before the protective circuit is activated. An in-line fuse lamp will trip out 7.5 watts RF. Control lines for keyer must be positive, cathode keying lines only. Amplifier switch time is less than 800 microseconds. The units measure 3 x 6.25 x 3.75 inches (7.6 x 15.9 x 9.5 cm) control, and 3.2 x 6.6 x 9.2 inches (8.1 x 16.8 x 23.5 cm) RF unit, and weigh 5 and 4 pounds (11 kg and 8.8 kg) respectively. The unit is available for \$279 from either Universal Amateur Radio, Inc., 1280 Aida Drive Reynoldsburg, Ohio 43068, or DEO, 4925 S Hamilton Drive., Grovesport, Ohio 43125.

Circle #307 on Reader Service Card.

### new 40-meter antenna

Telex/Hy-Gain has introduced the "Discoverer," a new series of 40-meter antennas developed for high-performance operations in response to the effects of declining sunspot activity on the 10-20 meter bands.

The new series consists of several configurations. The Discoverer 7-1 is a 45-foot (13.7 meter) rotatable dipole that can be added to many existing beam antenna installations and tuned to either 30 or 40 meters.

The Discoverer 7-2, a two-element beam with

\*\*\*\*\*  
**GO MOBILE WITH YOUR H.T.!**  
 Model I—Icom IC-2A/T, Etc.  
 Model K-1 for TR-2500  
 —slides on bottom of radio  
 Guaranteed!  
 Model K—TR-2400:  
 —powered thru battery plug  
 Model N—FT-208R  
 Model T—Simple mod for Tempo  
 and all Santec  
 NOW FOR FT-208R & TR-2500  
 Model Y—FT-207R, Wilson  
 —fits into battery compartment  
 \*A unique battery eliminator\*  
**HANDI-TEK** Regulator allows  
 constant hand-held operation  
 from auto DC or base supply  
 with no nicad drain and  
**WITHOUT RADIO MODIFICATION!**  
 \$24.95 PPD in USA.  
 Calif. add \$1.50 Sales Tax.  
 ✓ 142  
**HANDI-TEK**  
 P.O. BOX 556, DEER HAVEN, CA 92372  
 \*\*\*\*\*

## 1296 & PHASE III MAKI UTV 1200 - \$499<sup>95</sup> MAKI 20W AMP - \$430<sup>00</sup>

### KT 200 ET

**0-10 TRACKING PROG.**  
**TIMEX/ZX - 16K**  
**Vic-Basic \$12.95**  
Also Avail. w/RS & STS

SASE for full details on the  
Timex/ZX AUTOTRAK ROTOR  
CONTROLLER

**SPECTRUM WEST**  
5717 NE 56th, SEATTLE, WA 98105  
206-641-7461 ✓ 184

a wind load of only 6 square feet (0.56 meter<sup>2</sup>), requires only a 25-foot (7.6 meter) turning radius. In addition to high forward gain and front-to-back ratio, it maintains a broad bandwidth in excess of 190 kHz with SWR below 2:1.

The Discoverer 7-2 can be further enhanced with the addition of a Director Kit, thereby creating a three-element beam. This almost doubles the front-to-back ratio and forward gain, which in turn almost doubles the E.R.P. of the two-element version. All this fits on a 35-foot (10.7 meter) boom. The relatively compact array does not require a heavy-duty tower, but can be safely installed on a less expensive medium-duty tower such as the Hy-Gain HG52SS.

The suggested list price for the Discoverer 7-1 is \$195.00. The Discoverer 7-2 and the Director Kit are listed at \$435.00 and \$272.00 respectively.

For more information, contact Telex Communications, 9600 Aldrich Avenue South, Minneapolis, Minnesota 55420.

## Battery Manager™

Designed with the communications specialist in mind, the Battery Manager™ from URDC Measurements, Inc., analyzes and conditions all common types of 2-way radio NICAD batteries or optimum field performance and extended life.

The unit is specifically designed to combat "Memory Effect" — the premature loss of power from a battery that's just been fully charged. Caused by repetitive shallow discharging followed by repeated overcharging, Memory Effect reduces reliability in the field and plays havoc with battery replacement schedules.

With the Battery Manager™, batteries that have been discarded as "not usable" can often be reconditioned and returned to service, and the life of batteries currently in use can be extended.

Battery Manager™ operates on 110V, 60 Hz and can be adapted at the factory for use on 20V, 0 Hz. Its maximum power consumption is 150 watts.

For more information, contact URDC Measurements, Inc., P.O. Box 880, West Jordan, Utah 84084.

Circle #308 on Reader Service Card.



## New CMOS DTMF Chip Kit

Telone's TRK-957 Kit makes it easier and less expensive to breadboard a low-power, central office quality DTMF detection system. All you need is a power source from 5 to 12 VDC. The sensitivity, wide dynamic range, noise immunity, and low-power consumption make the TRK-957 ideal for telephone switching, computer, and remote control applications. The TRK-957 DTMF Kit is only \$24.75. To order call:

(800) 227-3800, ext. 1130.

TELONE®

✓ 189

# ANTENNAS & TOWERS

## THIS MONTH'S FEATURES:

HY-GAIN EXPLORER-14 — \$264.95

HY-GAIN TH7DXS — \$399.95

CUSHCRAFT A3 — \$202.00

CUSHCRAFT R3 — \$254.95

BUTTERNUT HF6V — \$106.00

(Accessories in stock)

NEW Hy Gain's 40 Mtr. Beam  
Write For Details/Prices

cushcraft

A3	\$202.00
A4	264.95
A743	67.95
A744	67.95
R3	254.95
AV3	49.95
AV4	87.95
AV5	95.00
40-2CD	269.95

A50-S	\$74.95
617-B	189.95
32-19	88.00
214B	73.00
220B	88.00
410B	54.95
424B	74.95

Stacking & Quad Kits!

ARX-2B	\$34.95
A147-11	44.95
A147-22	119.95
416TB	54.95
A144-20T	64.95
A144-10T	46.00
A14T-MB	26.00



hy-gain

TH7DXS	\$399.95
TH5Mk2S	349.95
Explorer-14	264.95
QK-710 add-on	74.95
392S Conv. Kit	129.95
204BAS	224.95
205BAS	299.95

18AVT/WB-S	\$89.95
14AVQ/WB-S	61.95
12AVQ-S	44.95
14RMQ	34.95
18HTS	395.00
V2S	36.95



ROTORS:

AR-40	\$87.95
CD-45II	119.95
HAM-IV	192.50
T2X	239.00
HDR-300	450.00



## WIRE & CABLE

(Coax quality guaranteed. 95%-plus shielding)

RG-213/U	\$0.29/ft.
RG-8/U	0.28/ft.
RG-8/U foam	0.27/ft.
RG-8X	0.15/ft.

Rotor cable-standard (6-22, 2-18)	0.18/ft.
Rotor cable-hvy. duty (6-18, 2-16)	0.32/ft.

450 ohm line	\$0.09/ft.
14 ga. copperweld (solid)	0.10/ft.
12 ga. copperweld (solid)	0.12/ft.

Unarco-Rohn

We stock 25G, 45G, HBX, & HDBX towers.

All accessories available. FOLD-OVER towers shipped freight pre-paid to your QTH!

25G	\$46/sect.	HBX48	\$250.00
45G	109/sect.	HBX56	320.00
FOLD-OVERS:		HDBX40	230.00
Get our quote & save!		HDBX48	315.00



hy-gain

Let us bid the self-supporting crank-up tower of your choice with the accessories you select.

HG-37SS	\$625.00
HG-52SS	900.00
HG-54HD	1459.00
HG-70HD	2300.00

Shipped freight paid. Order tower with Hy-Gain antenna, rotor & other accessories. Receive free shipping on all.

A tower is a major investment of time, money, and sweat. To be certain you get what you want and need to complete your installation, first time around, we suggest you write us with your itemized needs and get our written proposal. A few extra days now can save weeks of frustration and waiting later.

rf enterprises

Route No. 7  
St. Cloud, Minnesota 56301  
(612) 255-0855

✓ 176

Prices subject to change without notice or obligation. Minnesota residents add 6% tax. Shipping not included except as indicated.



## DIRECTION FINDING?

- ★ Doppler Direction Finding
- ★ No Receiver Mods
- ★ Mobile or Fixed
- ★ Kits or Assembled Units
- ★ 135-165 MHz Standard Range



- ★ Circular LED Display
- ★ Optional Digital Display
- ★ Optional Serial Interface
- ★ 12 VDC Operation
- ★ 90 Day Warranty

**New Technology** (patent pending) converts any VHF FM receiver into an advanced Doppler Direction Finder. Simply plug into receiver's antenna and external speaker jacks. Use any four omnidirectional antennas. Low noise, high sensitivity for weak signal detection. Kits from \$270. Assembled units and antennas also available. Call or write for full details and prices.

DOPPLER SYSTEMS, 5540 E. Charter Oak, Scottsdale, AZ 85254 (602) 998-1151

✓ 134

August 1984 123

# RF TRANSISTORS, MICROWAVE DIODES

TYPE	PRICE	TYPE	PRICE	TYPE	PRICE	TYPE	PRICE
2N1561	\$ 25.00	2SC1678	\$ 2.00	M1134	\$ 16.90	MSC1821-3	\$125.00
2N1562	25.00	2SC1729	20.00	M9579	7.95	MSC1821-10	225.00
2N1692	25.00	2SC1760	1.50	M9588	7.50	MSC2001	40.00
2N2957	1.55	2SC1909	4.00	M9622	7.95	MSC2223-10	200.00
2N2857JANTX	4.10	2SC1946	36.00	M9623	9.95	MSC3000	50.00
2N2857JANTXV	4.10	2SC1946A	40.00	M9624	11.95	MSC3001	50.00
2N2876	13.50	2SC1970	2.50	M9625	17.95	MSC73001	50.00
2N2947	18.35	2SC1974	4.00	M9630	18.00	MSC82001	40.00
2N2948	13.00	2SC2166	5.50	M9740	29.90	MSC82014	40.00
2N2949	15.50	2SC2237	32.00	M9741	29.90	MSC82020	40.00
2N3375	17.10	2SC2695	47.00	M9755	19.50	MSC82030	40.00
2N3553	1.55	A50-12	25.00	M9848	37.00	MSC83001	50.00
2N3632	15.50	A209	10.00	M9850	16.90	MSC83005	100.00
2N3733	11.00	A283	5.00	M9851	20.00	MT4150	14.40
2N3818	5.00	A283B	6.00	M9887	5.25	MT5126	POR
2N3866	1.30	AF102	2.50	MEL80091	25.00	MT5596/2N5596	99.00
2N3866JAN	2.20	AFY12	2.50	MM1550	10.00	MT5768/2N5768	95.00
2N3924	3.35	BF272A	2.50	MM1552	50.00	MT8762	POR
2N3927	17.25	BFR21	2.50	MM1553	50.00	NE02136	2.50
2N3950	25.00	BFR90	1.00	MM1614	10.00	NE13783	POR
2N4012	11.00	BFR91	1.65	MM1943/2N4072	1.80	NE21889	POR
2N4041	14.00	BFR99	2.50	MM2608	5.00	NE57835	5.70
2N4072	1.80	BFT12	2.50	MM3375A	17.10	NE73436	2.50
2N4080	4.53	BFW16A	2.50	MM4429	10.00	TRW	
2N4127	21.00	BFW17	2.50	MM8000	1.15	PRTB637	POR
2N4427	1.30	BFW92	1.50	MM8006	2.30	PT3190	POR
2N4428	1.85	BFX44	2.50	MM8011	25.00	PT3194	POR
2N4430	11.80	BFX48	2.50	MPF102	.45	PT3195	POR
2N4957	3.45	BFX65	2.50	MPSU31	1.01	PT3537	7.80
2N4959	2.30	BFX84	2.50	MRA2023-1.5	42.50	PT4166E	POR
2N5090	13.80	BFX85	2.50	MRP208	16.10	PT4176D	POR
2N5108	3.45	BFX86	2.50	MRP212	16.10	PT4186B	POR
2N5109	1.70	BFX89	1.00	MRP223	13.25	PT4209	POR
2N5160	3.45	BFY11	2.50	MRP224	15.50	PT4209C/5645	POR
2N5177	21.62	BFY18	2.50	MRP231	10.92	PT4556	24.60
2N5179	1.04	BFY19	2.50	MRP232	12.07	PT4570	7.50
2N5216	56.00	BFY39	2.50	MRP233	12.65	PT4577	POR
2N5583	3.45	BFY90	1.00	MRP237	3.15	PT4590	POR
2N5589	9.77	BLX67	15.24	MRP238	13.80	PT4612	POR
2N5590	10.92	BLX68C3	15.24	MRP239	17.25	PT4628	POR
2N5591	13.80	BLX93C3	22.21	MRP245	35.65	PT4640	POR
2N5637	15.50	BLY87A	8.94	MRP247	35.65	PT4642	POR
2N5641	12.42	BLY88C3	13.08	MRP304	43.45	PT5632	4.70
2N5642	14.03	BLY94C	21.30	MRP309	33.81	PT5749	POR
2N5643	15.50	BLY351	10.00	MRP314	28.52	PT6629	POR
2N5645	13.80	BLY568C/CF	30.00	MRP315	28.86	PT6709	POR
2N5646	20.70	C458-617	25.00	MRP316	25.00	PT6720	POR
2N5651	11.05	C4005	20.00	MRP317	63.94	PT8510	POR
2N5691	18.00	CD1899	20.00	MRP420	20.00	PT8524	POR
2N5764	27.00	CD2188	18.00	MRP421	36.80	PT8609	POR
2N5836	3.45	CD2545	25.00	MRP422A	41.40	PT8633	POR
2N5842/MM1607	8.45	CTC3005	100.00	MRP427	17.25	PT8639	POR
2N5849	20.00	Dexcel GaAs FET		MRP428	46.00	PT8659	POR
2N5913	3.25	DK13501A-PI00F	49.30	MRP433	12.07	PT8679	POR
2N5916	36.00	Fujitsu GaAs FET		MRP449/A	12.65	PT8708	POR
2N5922	10.00	FSX52WF	58.00	MRP450/A	14.37	PT8709	POR
2N5923	25.00	GMC290A	2.50	MRP453/A	18.40	PT8727	29.00
2N5941	23.00	HEP76	4.95	MRP454/A	20.12	PT8731	POR
2N5942	40.00	HEPS3002	11.40	MRP455/A	16.00	PT8742	19.10
2N5944	10.35	HEPS3003	30.00	MRP458	20.70	PT8787	POR
2N5945	11.50	HEPS3005	10.00	MRP463	25.00	PT9783	16.50
2N5946	14.40	HEPS3006	19.90	MRP472	1.00	PT9784	32.70
2N6080	10.35	HEPS3007	25.00	MRP475	3.10	PT9790	56.00
2N6081	12.07	HEPS3010	11.34	MRP476	2.00	PT31962	POR
2N6082	12.65	Hewlett Packard		MRP477	14.95	PT31963	POR
2N6083	13.25	HFET2204	112.00	MRP492	23.00	PT31083	POR
2N6084	15.00	35821E	38.00	MRP502	1.04	PTX6680	POR
2N6094	11.00	35826B	32.00	MRP503	6.00	RCA	
2N6095	12.00	35826E	32.00	MRP504	7.00	40081	5.00
2N6096	16.10	35831E-H31	30.00	MRP509	5.00	40279	10.00
2N6097	20.70	35831E	30.00	MRP511	10.69	40280	4.62
2N6105	21.00	35832E	50.00	MRP515	2.00	40281	10.00
2N6136	21.85	35833E	50.00	MRP517	2.00	40282	20.00
2N6166	40.24	35853E	71.50	MRP559	2.05	40290	2.80
2N6201	50.00	35854E	75.00	MRP605	20.00	40292	13.05
2N6304	1.50	35866E	44.00	MRP618	25.00	40294	2.50
2N6459	18.00	HXTR3101	7.00	MRP628	8.65	40341	21.00
2N6567	10.06	HXTR3102	8.75	MRP629	3.45	40608	2.48
2N6680	80.00	HXTR5104	30.00	MRP644	27.60	40894	1.00
2SC703	3.00	HXTR6104	68.00	MRP646	29.90	40977	10.00
2SC756A	7.50	HXTR6105	31.00	MRP616	15.00	62800A	60.00
2SC781	2.80	HXTR6106	33.00	MRP823	20.00	RE3754	25.00
2SC1018	1.00	J310	.70	MRP901 (3) Lead	1.00	RE3789	25.00
2SC1042	12.00	TRW		MRP901 (4) Lead	2.00	RF110	25.00
2SC1070	2.50	JO2000	10.00	MRP904	2.30	S50-12	25.00
2SC1239	2.50	JO2001	25.00	MRP911	3.00	S3006	5.00
2SC1251	12.00	JO4045	25.00	MRP961	2.30	S3031	5.00
2SC1306	2.90	Motorola Comm.		MRP8004	2.10	SCA3522	5.00
2SC1307	5.50	M1131	8.50	MS261F	POR	SCA3523	5.00
2SC1424	2.80	M1132	11.95	MSC1720-12	225.00	PRICE ON REQUEST = POR	

**Toll Free Number**  
**800-528-0180**  
**(For orders only)**

"All parts may be new or surplus, and parts may be substituted with comparable parts if we are out of stock of an item."

For information call: (602) 242-3037

PRICES SUBJECT TO CHANGE WITHOUT NOTICE

**MHz electronics**



# GaAs, TUNNEL DIODES, ETC.

\* R F TRANSISTORS \*

TYPE	PRICE	TYPE	PRICE	TYPE	PRICE	TYPE	PRICE
<u>THOMSON CSF</u>							
SD345	\$ 5.00	SD1119	\$ 5.00	SD1278-5	\$18.00	SD1453-1	\$48.00
SD445	5.00	SD1124	50.00	SD1281-2	8.00	SD1454-1	48.00
SD1004	15.00	SD1127	3.50	SD1283	10.00	SD1477	48.00
SD1009	15.00	SD1133	14.00	SD1289-1	15.00	SD1478	21.00
SD1009-2	15.00	SD1133-1	14.00	SD1290-1	15.00	SD1480	60.00
SD1012	9.90	SD1134-1	3.00	SD1290-7	15.00	SD1484	1.50
SD1012-3	9.90	SD1135	8.00	SD1300	3.00	SD1484-5	1.50
SD1012-5	9.90	SD1136	15.00	SD1301-7	3.00	SD1484-6	1.50
SD1013-3	13.50	SD1143-2	15.00	SD1305	3.00	SD1484-7	1.50
SD1013-7	13.50	SD1143-1	12.00	SD1307	3.00	SD1488	39.00
SD1014	11.00	SD1143-3	17.00	SD1308	3.00	SD1488-1	28.00
SD1014-6	11.00	SD1144-1	3.00	SD1311	1.00	SD1488-7	27.00
SD1016	15.00	SD1146	15.00	SD1317	10.00	SD1488-8	28.00
SD1016-5	15.00	SD1147	15.00	SD1335	3.00	SD1499-1	39.00
SD1018-4	15.00	SD1188	10.00	SD1345-6	5.00	SD1520-2	18.00
SD1018-6	15.00	SD1189	24.00	SD1365-1	2.50	SD1522-4	33.00
SD1018-7	15.00	SD1200	1.50	SD1365-5	2.50	SD1528-1	24.00
SD1018-15	15.00	SD1201-2	10.00	SD1375	7.50	SD1528-3	34.00
SD1020-5	10.00	SD1202	10.00	SD1375-6	7.50	SD1530-2	38.00
SD1028	15.00	SD1212-11	4.00	SD1379	15.00	SD1536-1	41.00
SD1030-2	12.00	SD1212-12	4.00	SD1380-1	1.00	SD1545	34.00
SD1043	12.00	SD1212-16	4.00	SD1380-3	1.00	SD1561	79.00
SD1043-1	10.00	SD1214-7	5.00	SD1380-7	1.00	SF4557 Mot.	25.00
SD1045	3.75	SD1214-11	5.00	SD1405	40.00	SK3048 RCA	5.00
SD1049-1	2.00	SD1216	12.00	SD1409	18.00	SK3177 RCA	15.00
SD1053	4.00	SD1219-4	15.00	SD1410	22.00	SMS7714 Mot.	2.50
SD1065	4.75	SD1219-5	15.00	SD1410-3	21.00	SRF750 Mot.	36.00
SD1068	15.00	SD1219-8	15.00	SD1413-1	18.00	SRF1018 Mot.	5.00
SD1074-2	18.00	SD1220	8.00	SD1416	50.00	SRF2147 Mot.	22.00
SD1074-4	28.00	SD1220-9	8.00	SD1422-2	24.00	SRF2356 Mot.	38.00
SD1074-5	28.00	SD1222-8	16.00	SD1428	33.00	SRF2378 Mot.	16.00
SD1076	20.00	SD1222-11	7.50	SD1429-2	15.00	SRF2584 Mot.	40.00
SD1077-4	4.00	SD1224-10	18.00	SD1429-3	15.00	SRF2821 Mot.	25.00
SD1077-6	4.00	SD1225	18.00	SD1429-5	15.00	SRF2857 Mot.	20.00
SD1078-6	24.00	SD1228-8	POR	SD1430	12.00	TAR8894 RCA	15.00
SD1080-8	6.00	SD1229-7	13.00	SD1430-2	18.00	TIS189/MRF966	3.55
SD1080-9	3.00	SD1229-16	13.00	SD1434-5	30.00	TP312	2.50
SD1084	8.00	SD1232	4.00	SD1434-9	30.00	TP1014 TRW	5.00
SD1087	15.00	SD1240-8	15.00	SD1438	26.00	TP1028 TRW	15.00
SD1089-5	15.00	SD1244-1	14.00	SD1441	91.00	01-80703T04/	
SD1095	15.00	SD1262	12.00	SD1442	15.00	458-949 Mot. Comm.	65.00
SD1100	5.00	SD1263	15.00	SD1444	6.00	TKV72201 H.P.	450.00
SD1109	18.00	SD1263-1	15.00	SD1444-8	6.00	62803 RCA	100.00
SD1115-2	8.00	SD1272	13.00	SD1450-1	28.00	TA7205/2N5921	80.00
SD1115-3	8.00	SD1272-2	15.00	SD1451	18.00	TA7487/2N5920	75.00
SD1115-7	2.50	SD1272-4	15.00	SD1451-2	18.00	TA7995/2N6267	150.00
SD1116	5.00	SD1278	20.00	SD1452	20.00	SRF2092 Mot.	18.00
SD1118	22.00	SD1278-1	18.00	SD1452-2	20.00	MRF479	8.05

We Can Cross Reference Most RF Transistors, Diodes, Hybrid Modules And Any Other Type Of Semiconductor.

\* DIODES (HOT CARRIER, MICROWAVE, PIN, SCHOTTKY, TUNNEL, VARACTOR, GUNN) \*

1N21	\$ 3.40	1N21B	\$ 3.40	1N21BR	\$ 3.40	1N21C	\$ 3.40
1N21D	4.00	1N21DR	4.00	1N21FR	6.00	1N21RF	5.00
1N21WE	5.80	1N21WG	5.80	1N22	5.00	1N23A	10.00
1N23B	3.40	1N23C	3.40	1N23CR	3.40	1N23D	4.95
1N23DR	4.00	1N23WE	5.00	1N25	7.50	1N25AR	18.00
1N28WE	10.00	1N29	10.00	1N32	20.00	1N53A	55.50
1N76	26.00	1N76R	28.00	1N78	26.00	1N78A	20.00
1N78B	28.00	1N78D	28.00	1N78DR	28.00	1N78R	28.00
1N149	6.00	1N150MR	18.00	1N415	4.00	1N415C	4.00
1N415G	15.00	1N416D	5.00	1N416F	6.00	1N446	10.00
1N831	10.00	1N833	10.00	1N950	4.00	1N1084	2.00
1N2930	15.00	1N2932	15.00	1N3540	15.00	1N3712	11.00
1N3713	18.00	1N3714	11.00	1N3715	16.00	1N3716	10.00
1N3717	14.00	1N3718	10.00	1N3721	14.00	1N3733	10.00
1N3747	21.00	1N4386	20.00	1N4396	15.00	1N4785	11.00
1N4812B	9.00	1N5139A/B	4.25	1N5140A/B	4.25	1N5141A/B	4.25
1N5142A/B	4.25	1N5143A/B	4.25	1N5144A/B	4.25	1N5145A/B	4.25
1N5146A/B	4.25	1N5147A/B	4.25	1N5148A/B	4.25	1N5167	5.50
1N5453	3.75	1N5465	7.65	1N5711	1.00	1N5711 JAN	2.00
1N5713	5.00	1N5767	2.00	1N6263	1.00	1S2199	15.00
1S2200	15.00	1S2208/9	1.00	8B1087/48R869558	65.00	8D3020	65.00
A2X116M Aertech	50.00	BB105B	1.00	BB105G	1.00	BD4/4JFBD4 G.E.	15.00
BL161 Bomac	5.00	CM6144B C.M.	POR	D4060 Alpha	POR	D4159 Alpha	POR
D4233B Alpha	POR	D4900 Alpha	POR	D4959 Alpha	POR	D4987M Alpha	POR
D6047C Alpha	POR	D6147D Alpha	POR	D5503 Alpha	POR	D5506 Alpha	POR
DG86158-98 Alpha	POR	DMD6022 Alpha	POR	DMD6460A Alpha	POR	DF20054 Crown	POR
GC1691-89 GHZ	31.35	GC1602-89 GHZ	31.35	GC1607-40 GHz	31.35	GC2531-88 GHz	37.40
GC2542-46 GHz	37.40	GC3208-40 GHz	37.40	GC17044 GHz	50.00	HP33644A-H01	125.00
HP5082-0112	14.20	HP5082-0241	75.60	HP5082-0253	105.00	HP5082-0320	58.00
HP5082-0375	POR	HP5082-0386	POR	HP5082-0401	POR	HP5082-0438	POR
HP5082-1028	POR	HP5082-1332	POR	HP5082-2254	POR	HP5082-2302	10.70
HP5082-2303	5.20	HP5082-2696	POR	HP5082-2711	23.15	HP5082-2727	POR
HP5082-2800	1.00	HP5082-2805	4.45	HP5082-2835	1.00	HP5082-2884	POR
HP5082-3039	6.70	HP5082-3040	36.00	HP5082-3080	2.00	HP5082-3188	1.00
HP5082-3379	1.50	HP5082-6459	POR	HP5082-6462	POR	HP5082-6888	POR
HP5082-8016	POR	HP5082-8323	POR	K3A Kometron	7.00	MA450A	POR
MA475	POR	MA40008	POR	MA41487	POR	MA41765	POR
MA41766	POR	MA43004	48.00	MA43589	POR	MA43622	POR
MA43636	POR	MA45104	27.00	MA47044	POR	MA47051	25.50
MA47100	3.05	MA47202	30.80	MA47771	POR	MA47838*	POR
MA47852	POR	MA49106	37.95	MA49558	POR	MA86731	125.00

\* OUR STOCK CHANGES DAILY SO CALL IF THE PART YOU NEED IS NOT LISTED \*

For information call: (602) 242-3037

**Toll Free Number**  
**800-528-0180**  
**(For orders only)**

"All parts may be new or surplus, and parts may be substituted with comparable parts if we are out of stock of an item."

**MHz electronics**

PRICES SUBJECT TO CHANGE WITHOUT NOTICE



COAXIAL RELAY SWITCHES SPDT

Electronic Specialty Co./Raven Electronics FSN 5985-556-9683 \$49.00  
 Part # 25N28 Part # SU-01  
 26Vdc Type N Connector, DC to 1 GHz.



Amphenol  
 Part # 316-10102-8  
 115Vac Type BNC DC to 3 GHz.

\$29.99

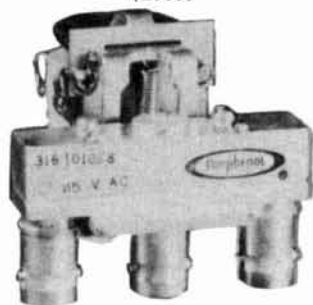

FXR  
 Part # 300-11182  
 120Vac Type BNC DC to 4 GHz.  
 FSN 5985-543-1225

\$39.99

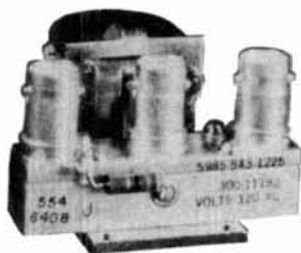

FXR  
 Part # 300-11173  
 120Vac Type BNC Same  
 FSN 5985-543-1850

\$39.99

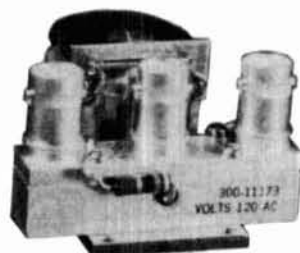

BNC To Banana Plug Coax Cable RG-58 36 inch or BNC to N Coax Cable RG-58 36 inch.

\$7.99 or 2 For \$13.99 or 10 For \$50.00

\$8.99 or 2 For \$15.99 or 10 For \$60.00



SOLID STATE RELAYS

P&B Model ECT1DB72 5vdc turn on  
 PRICE EACH \$5.00

Digisig, Inc. Model ECS-215 5vdc turn on  
 PRICE EACH \$7.50

Grigsby/Barton Model GB7400 5vdc turn on  
 PRICE EACH \$7.50

120vac contact at 7amps or 20amps on a 10"x 10"x .124 aluminum. Heatsink with silicon grease.

240vac contact 14amps or 40amps on a 10"x 10"x .124 aluminum. Heatsink with silicon grease.

240vac contact at 15amps or 40amps on a 10"x 10"x .124 aluminum. Heatsink with silicon grease.

NOTE: \*\*\* Items may be substituted with other brands or equivalent model numbers. \*\*\*

For information call: (602) 242-3037

**MHz** electronics

"All parts may be new or surplus, and parts may be substituted with comparable parts if we are out of stock of an item."

**Toll Free Number**  
**800-528-0180**  
**(For orders only)**

PRICES SUBJECT TO CHANGE WITHOUT NOTICE

# TUBES

TYPE	PRICE	TYPE	PRICE	TYPE	PRICE
2C39/7289	\$ 34.00	1182/4600A	\$500.00	ML7815AL	\$ 60.00
2E26	7.95	4600A	500.00	7843	107.00
2K28	200.00	4624	310.00	7854	130.00
3-500Z	102.00	4657	84.00	ML7855KAL	125.00
3-1000Z/8164	400.00	4662	100.00	7984	14.95
3B28/866A	9.50	4665	500.00	8072	84.00
3CX400U7/8961	255.00	4687	P.O.R.	8106	5.00
3CX1000A7/8283	526.00	5675	42.00	8117A	225.00
3CX3000F1/8239	567.00	5721	250.00	8121	110.00
3CW30000H7	1700.00	5768	125.00	8122	110.00
3X2500A3	473.00	5819	119.00	8134	470.00
3X3000F1	567.00	5836	232.50	8156	12.00
4-65A/8165	69.00	5837	232.50	8233	60.00
4-125A/4D21	79.00	5861	140.00	8236	35.00
4-250A/5D22	98.00	5867A	185.00	8295/PL172	500.00
4-400A/8438	98.00	5868/AX9902	270.00	8458	35.00
4-400B/7527	110.00	5876/A	42.00	8462	130.00
4-400C/6775	110.00	5881/6L6	8.00	8505A	95.00
4-1000A/8166	444.00	5893	60.00	8533W	136.00
4CX250B/7203	54.00	5894/A	54.00	8560/A	75.00
4CX250FG/8621	75.00	5894B/8737	54.00	8560AS	100.00
4CX250K/8245	125.00	5946	395.00	8608	38.00
4CX250R/7580W	90.00	6083/AZ9909	95.00	8624	100.00
4CX300A/8167	170.00	6146/6146A	8.50	8637	70.00
4CX350A/8321	110.00	6146B/8298	10.50	8643	83.00
4CX350F/8322	115.00	6146W/7212	17.95	8647	168.00
4CX350FJ/8904	140.00	6156	110.00	8683	95.00
4CX600J/8809	835.00	6159	13.85	8877	465.00
4CX1000A/8168	242.50*	6159B	23.50	8908	13.00
4CX1000A/8168	485.00	6161	325.00	8950	13.00
4CX1500B/8660	555.00	6280	42.50	8930	137.00
4CX5000A/8170	1100.00	6291	180.00	6L6 Metal	25.00
4CX10000D/8171	1255.00	6293	24.00	6L6GC	5.03
4CX15000A/8281	1500.00	6326	P.O.R.	6CA7/EL34	5.38
4CW800F	710.00	6360/A	5.75	6CL6	3.50
4D32	240.00	6399	540.00	6DJ8	2.50
4E27A/5-125B	240.00	6550A	10.00	6DQ5	6.58
4PR60A	200.00	6883B/8032A/8552	10.00	6GF5	5.85
4PR60B	345.00	6897	160.00	6GJ5A	6.20
4PR65A/8187	175.00	6907	79.00	6GK6	6.00
4PR1000A/8189	590.00	6922/6DJ8	5.00	6HB5	6.00
4X150A/7034	60.00	6939	22.00	6HF5	8.73
4X150D/7609	95.00	7094	250.00	6JG6A	6.28
4X250B	45.00	7117	38.50	6JM6	6.00
4X250F	45.00	7203	P.O.R.	6JN6	6.00
4X500A	412.00	7211	100.00	6JS6C	7.25
5CX1500A	660.00	7213	300.00*	6KN6	5.05
KT88	27.50	7214	300.00*	6KD6	8.25
416B	45.00	7271	135.00	6LF6	7.00
416C	62.50	7289/2C39	34.00	6LQ6 G.E.	7.00
572B/T160L	49.95	7325	P.O.R.	6LQ6/6MJ6 Sylvania	9.00
592/3-200A3	211.00	7360	13.50	6ME6	8.90
807	8.50	7377	85.00	12AT7	3.50
811A	15.00	7408	2.50	12AX7	3.00
812A	29.00	7609	95.00	12BY7	5.00
813	50.00	7735	36.00	12JB6A	6.50

NOTE \* = USED TUBE

NOTE P.O.R. = PRICE ON REQUEST

"ALL PARTS MAY BE NEW, USED, OR SURPLUS. PARTS MAY BE SUBSTITUTED WITH COMPARABLE PARTS IF WE ARE OUT OF STOCK OF AN ITEM.

NOTICE: ALL PRICES ARE SUBJECT TO CHANGE WITHOUT NOTICE.

For information call: (602) 242-3037

**Toll Free Number**  
**800-528-0180**  
**(For orders only)**

"All parts may be new or surplus, and parts may be substituted with comparable parts if we are out of stock of an item."

**MHz electronics**

PRICES SUBJECT TO CHANGE WITHOUT NOTICE

# HEWLETT PACKARD SIGNAL GENERATORS

606A	50KHz to 65MHz in 6 bands $\pm 1\%$ Output level adjustable 0.1uV to 3V into 50 ohms. Built-in crystal calibrator. 400 - 1000Hz modulation.	\$ 650.00	616B	Same as above but later model.	\$ 600.00
606B	Same as above but has frequency control feature to allow operation with HP 8708A Synchronizer.	\$1100.00	618B	3.8 to 7.6MHz range, with calibrated output and selection of pulse-FM or square wave modulation.	\$ 600.00
608C	10MHz to 480MHz, 0.1uV-1V into 50 ohms, AM, CW, or pulse modulation, calibrated attenuator.	\$ 500.00	618C	Same as above but later model.	\$2200.00
608D/TS510	10MHz to 420MHz, 0.1uV-0.5V into 50 ohms, $\pm 0.5\%$ accuracy, built-in crystal calibrator, AM-CW or pulse output.	\$ 375.00	620A	7 to 11GHz range, with calibrated output and selection of pulse-FM or square wave modulation.	\$ 750.00
608E	Improved version of popular 608C. Up to 1V output. Improved stability, low residual FM.	\$1450.00	620B	Same as above but later model.	\$2200.00
608F	10MHz to 455MHz in 5 bands $\pm 1\%$ frequency accuracy with built-in crystal calibrator. Can be used with HP 8708A Synchronizer. Output continuously adjustable from .1uV to .5V into 50 ohms.	\$1100.00	626A	10 to 15GHz, 10mW output power with calibrated output and pulse-square wave or FM modulation.	\$4200.00
612A	450-1230MHz .0.1uV-0.5V into 50 ohms, calibrated output.	\$ 750.00	8708A	Synchronizer used with 606B, 608F. The synchronizer is a phase-lock frequency stabilizer which provides crystal-oscillator frequency stability to 450MHz in the 608F signal generator. Phase locking eliminates microphonics and drift resulting in excellent frequency stability. The 8708A includes a vernier which can tune the reference oscillator over a range of $\pm 0.25\%$ permitting frequency stability to 2 parts in 10 to the seventh. Provides a very stable signal that satisfies many critical applications.	(With HP 606B or 608F) \$ 350.00 (Without) \$ 450.00
614A	900-2100MHz with many features including calibrated output and all modulation characteristics.	\$ 500.00	EMC-10	ELECTROMETRICS EMC-10 RFI/EMI RECEIVER Low frequency analyzer covering 20Hz to 50KHz frequency range. Extendable to 500 KHz in wideband mode.	\$2500.00
616A/TS403	Direct reading and direct control from 1.8 to 4.2GHz. The H.P. 616A features $\pm 1.5$ dB calibrated output accuracy from -3127dBm to -dBm. The output is directly calibrated in microvolts and dBm with continuous monitoring. Simple operation - frequency dial accuracy is $\pm 1\%$ and stability exceeds 0.005% / C change in ambient temperature. Calibrated attenuator is within $\pm 1.5$ dB over entire output band. 50 ohm impedance unit has internal pulse modulation with rep rate variable from 40 Hz to 4KHz, variable pulsewidth (1 to 10usec) and variable pulse delay (3 to 300usec). External modulating inputs increase versatility.	\$ 375.00	NF-105F	Empire Devices Field Intensity Meter. Hos NF-105/TA, NF-105/TX, NF-105/T1, NF-105/T2, NF-105/T3. Covers 14KHz to 1000MHz.	\$2100.00

ALL EQUIPMENT CARRY A 30 DAY GUARANTEE.

EQUIPMENT IS NOT CALIBRATED.

TERMS: DOMESTIC: Prepaid, C.O.D. or Credit Card  
FOREIGN: Prepaid only, U.S. Funds, Money Order, or Cashier's Check Only.

C.O.D.: Acceptable by telephone or mail. Payment from customer will be by Cash, Money Order, or Cashier's Check. We are sorry but we cannot accept personal checks for C.O.D.'s. C.O.D.'s are shipped by air only and thru United Parcel Service.

CONFIRMING ORDERS: We would prefer that confirming orders not be sent after a telephone order has been placed. If company policy necessitates a confirming order, please mark "CONFIRMING" boldly on the order. If problems or duplicate shipments occur due to an order which is not properly marked, the customer will be held responsible for any charges incurred, plus a 15% restock charge on the returned parts.

CREDIT CARDS: We are now accepting MASTERCARD, VISA, AND AMERICAN EXPRESS

DATA SHEETS: When we have data sheets in stock on devices we will supply them with the order.

DEFECTIVE MATERIALS: All claims for defective materials must be made within 30 DAYS after receipt of the parcel. All claims must include the defective material (for testing purposes), a copy of our invoice, and a return authorization number which must be obtained prior to shipping the merchandise back to us. This can be obtained by calling (602) 242-8916 or sending us a postcard. Due to Manufacturer warranties we are unable to replace or issue credit on items which have been soldered to or have been altered in any way. All return items must be packed properly or it will void all warranties. We do not assume responsibility for shipping and handling charges incurred.

DELIVERY: Orders are usually shipped the same day they are placed or the next business day, unless we are out of stock on an item. The customer will be notified by post card if we are going to backorder the item. Our normal shipping method is UPS or U.S. Mail depending on size or the weight of the package. Test Equipment is shipped only by air and is freight collect, unless prior arrangements have been made and approved.

FOREIGN ORDERS: All foreign orders must be prepaid with a Cashier's Check, or Money Order made out in U.S. FUNDS ONLY. We are sorry but C.O.D. is not available to foreign countries and letters of credit are unacceptable as a form of payment. Further information is available on request.

HOURS: Monday thru Friday 8:30 a.m. to 5:00 p.m. Saturdays 8:30 a.m. to 4:00 p.m.

INSURANCE: Please include 25¢ for each additional \$100.00 over \$100.00, UPS ONLY. All insured packages are shipped thru UPS only. If you wish to have it shipped through the post office there is a \$5.00 fee which is additional to the shipping, handling and insurance.

OPEN ACCOUNTS: We regret that we do not issue open accounts.

ORDER FORMS: New order forms are included with each order for your convenience. Additional order forms are available on request.

PARTS: We reserve the right to substitute or replace any item with a part of equal or comparable specification.

POSTAGE: Minimum shipping and handling in the U.S., Canada, and Mexico is \$3.00 for ground shipments, all other countries is \$5.50. Air rates are available at the time of your order. All foreign orders please include 25% of the ordered amount for shipping and handling. C.O.D.'s are shipped AIR ONLY.

PREPAID ORDERS: Orders must be accompanied by a check.

PRICES: Prices are subject to change without notice.

PURCHASE ORDERS: We accept purchase orders only when they are accompanied by a check.

RESTOCK CHARGES: If parts are returned to MHZ ELECTRONICS, INC. due to customer error, the customer will be held responsible for all fees incurred and will be charged a 15% RESTOCK CHARGE with the remainder in CREDIT ONLY. The following must accompany any return: A copy of our invoice, return authorization number which must be obtained prior to shipping the merchandise back. Returns must be done within 10 DAYS of receipt of parcel. Return authorization numbers can be obtained by calling (602) 242-8916 or notifying us by post card. Return authorizations will not be given out on our 800 number.

SALES TAX: ARIZONA residents must add 6% sales tax, unless a signed ARIZONA resale tax card is currently on file with us. All orders placed by persons outside of ARIZONA, but delivered to persons in ARIZONA are subject to the 6% sales tax.

SHORTAGE OR DAMAGE: All claims for shortages or damages must be made within 5 DAYS of receipt of parcel. Claims must include a copy of our invoice, along with a return authorization number which can be obtained by contacting us at (602) 242-8916 or sending a post card. Authorizations cannot be on our 800 number. All items must be properly packed. If items are not properly packed make sure to contact the carrier so that they can come out and inspect the package before it is returned to us. Customers which do not notify us within this time period will be held responsible for the entire order as we will consider the order complete.

OUR 800 NUMBER IS STRICTLY FOR ORDERS ONLY (800) 528-0180. INFORMATION CALLS ARE TAKEN ON (602) 242-8916 or (602) 242-3037.

UNEX LABORATORIES THS-2 FLEXICOM HEADSET.

these headsets come with data to hook up to a ICOM radios and many other equipment.

Perfect for Airplanes, Helicopters, Mobile Radios, or Just the Telephone.

These Are Factory New In Sealed Boxes. Limited Supply Only

\$69.95



## MHz electronics

2111 W. CAMELBACK ROAD  
PHOENIX, ARIZONA 85015

"All parts may be new or surplus, and parts may be substituted with comparable parts if we are out of stock of an item."



Toll Free Number  
800-528-0180  
(For orders only)

For information call: (602) 242-3037

PRICES SUBJECT TO CHANGE WITHOUT NOTICE.

# IC-271H

## Now a 100 Watt, 2 Meter Base!



For the ultimate in two-meter communications, ICOM presents the IC-271H transceiver with a high dynamic range receiver and a 100 watt transmitter. Operating from the IC-PS30, IC-PS15, or the internal IC-PS35 (optional), the IC-271H brings all the advanced functions of the latest CPU controlled radios to your shack.

**100 Watts.** Now a two-meter base station with 100 watts of internal power! The IC-271H provides all the power required for operation from remote places to repeaters, or for simplex.

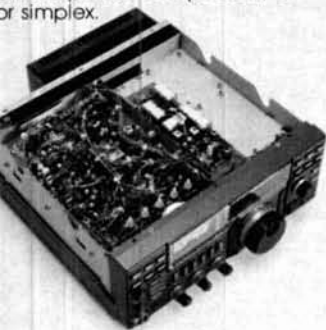

### Subaudible Tones.

Included as a standard feature are 32 built-in subaudible tones which are easily selected by rotating the main tuning knob. PL tones may be stored into memory.

### 32 Full-Function Memories.

Each tunable memory holds frequency, offset, offset direction, mode and subaudible tone. Each parameter is selected by rotating the main tuning knob in conjunction with the switches on the front panel.

**PLL Locked at 10Hz.** An extremely low-noise, professional receiver and a good signal-to-noise ratio PLL allows the IC-271H's synthesizer to lock to 10Hz providing receiver performance unparalleled by any other VHF receiver.

**Fluorescent Display.** ICOM's high-visibility, multicolor display gives easy-to-read display of all information necessary for logging a contact. Frequency, mode, duplex, offset direction, RIT frequency, memory channel and PL tone can be displayed.

**Scanning.** The IC-271H can scan memories and programmed sections of the band or modes. Mode-S scan can be used to scan only memories with a particular mode or lock out frequencies continuously busy so the receiver will not stop at that memory channel while scanning.

### Other Standard Features.

To facilitate the operation of the IC-271H, ICOM has incorporated a duplex check switch, all-mode squelch, receive audio tone control, S-meter, center meter, seven-year lithium battery memory backup, accessory connector and microphone.

**Optional Features.** IC-271H options are: switchable preamplifier, CTCSS encoder/decoder (encoder is standard), computer interface and voice synthesizer.

**Size.** Only 11¼ inches wide by 4¾ inches high, the IC-271H is styled to look good and engineered for ease of operation.



IC-271H  
Shown with internal  
power supply, IC-PS35

**The IC-271A.** The IC-271A with 25 watt output is available and has the same features as the IC-271H, plus an optional IC-PS25 internal power supply to make it a compact, go-anywhere two-meter base station. See the IC-271A(H) and other fine ICOM equipment at your ICOM dealer today.



# ICOM

## The World System



## MOSLEY...A BETTER ANTENNA... Antennas For 40 Meters...

- \*ALL STAINLESS HARDWARE
- \*NO MEASURING
- \*2 YEAR WARRANTY
- \*5 KW P.E.P.
- \*BROAD BAND WIDTH
- \*BUILT TO LAST
- \*NO BALUN NEEDED



S-401 M

Easy as... 1 - S-401 M. A 40 Meter Rotatable Dipole which gives you excellent bandwidth and performance. MOSLEY's S-401 M is the best 40 Meter Dipole ever built. All stainless hardware is standard. We have made it even stronger than before! We have added 2 extra insulator blocks and 2 feet more rectangle. The center of the elements are reinforced with an unbreakable non-conductive rod which makes it just about indestructible. Our link coupled feed system provides for an efficient match which enables you to direct feed the antenna with no need for a balun. This is why we give a 2 year warranty on parts, material, and workmanship.

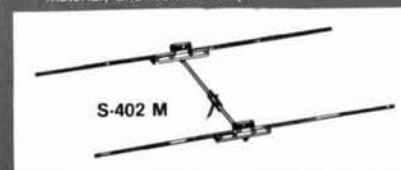

S-402 M

2 - Our S-402 M is now on a 24 foot boom and has all of the new improved structural changes. This antenna will give you years of outstanding mechanical and electrical performance in any climate. We feel this is the best performing, maintenance free, 2 element 40 Meter beam built anywhere in the world. Check it out! We believe you will agree. The elements are heavier constructed than other brands, and only reduces to 1 1/8 x .058 wall at their ends. Compare this to the other manufacturers. The S-402 M also comes with our 2 year warranty!



S-403

3 - The S-403 is the killer of the three models. This antenna gives you full size performance and is built to last. Our 36 foot boom is made out of 2" x .104 wall with a 24 foot sleeve of 1.785 x .125 wall. This gives you a wall thickness of .229 over 24 feet of the boom. The S-403 is spaced to give you the best front to back and forward gain. It will give you the whole 40 Meter band to chase DX or rag chew. Our S-403 also comes with our 2 year warranty.

If you are a new ham and are not familiar with MOSLEY, ask an older ham about us or call the PRESIDENT of MOSLEY. He will be glad to explain why MOSLEY is A BETTER ANTENNA...

These and other MOSLEY products are available through your favorite DEALER. Or write or call MOSLEY for the DEALER nearest you.

**Mosley Electronics Inc.**

1344 BAUR BLVD. ST. LOUIS, MISSOURI 63132

166

## MICROWAVE TEST EQUIPMENT

### RMSG Signal Generators

Manual tuning • 8-30 VDC input power • .1 to .7 volt (except greater than .6 volt for -7) output to tuned 50 ohm detector.



RMSG	Freq. (GHZ)	Electrical Tune (MHZ)	Price
-1	3.7-4.2	30	\$51.16
-3	2.1-2.2	6	\$61.16
-5	2.3-2.45	6	\$61.16
-7	5.9-6.1	10 to 1	\$91.20

### RMVO Voltage Tuned Oscillators

12 V. bias • -1 to -12 V. tuning • 1" X 1 1/2" PCB

RMVO	Freq. (GHZ)	Price
-1	2.1-2.5	\$24.95
-2	1.8-2.1	\$24.95

### ROENSCH MICROWAVE

R R 1, Box 156B, PH: 816-963-2550  
BROOKFIELD, MISSOURI 64628



## SYNTHESIZED SIGNAL GENERATOR

MADE IN USA



MODEL SG-100E  
\$399.95  
plus shipping

- Covers 100 MHz to 185 MHz in 1 kHz steps with thumbwheel dial
- Accuracy +/- 1 part per 10 million at all frequencies
- Internal FM adjustable from 0 to 100 kHz at a 1 kHz rate
- External FM input accepts tones or voice
- Spurs and noise at least 60 dB below carrier
- Output adjustable from 5-500 mV at 50 Ohms
- Operates on 12 Vdc @ 1/2 Amp
- Available for immediate delivery
- \$399.95 plus shipping
- Add-on accessories available to extend freq range, add infinite resolution, AM, and a precision 120 dB attenuator
- Call or write for details
- Phone in your order for fast COD shipment.

### VANGUARD LABS

196-23 Jamaica Ave., Hollis, NY 11423  
Phone: (212) 468-2720

193

## ATTENTION DEALERS!

Interested in making a PROFIT?

Sell our magazine in your store with 100% Return Privileges

Rose will tell you how —

CALL 1-603-878-1441

The Ham Radio Publishing Group

Greenville, NH 03048



24 DB GAIN UHF/VHF/FM ANTENNA/LINE AMPLIFIER  
AUV-724

75 Ohm in and out  
\$19.50 EACH 3/\$17.50 EACH

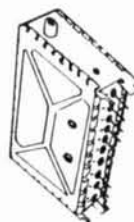

AMNEC EPU 202 UHF VARACTOR TUNER  
REC. CHANNELS: 14-83  
ANTENNA INPUT: 75 Ohm  
\$12.95 EACH 100 & OVER

Accessory Specialties  
SHIPPED U.S.

P.O. BOX 488 HAWTHORNE, CA 90250  
TELEPHONE (213) 324-1973  
WE ACCEPT MONEY ORDER, VISA, MASTERCARD  
PERSONAL CHECK ORDERS HELD 30 DAYS. NO COD  
ADD \$1.50 for Shipping & Handling. CA Residents ADD 6.5% TAX

## PRECISION PROCESSING



The E-CLIPS Model III

Provides total dynamic range control with very low distortion

- Selectable processing modes—envelope compression or peak limiting
- Variable high and low frequency response equalization
- Five segment LED display
- Easy to install and use with any transmitter/transceiver

Introductory price—\$189.95 ppd.

For brochure with complete technical specifications contact:

ANALOG TECHNOLOGY

P.O. Box 8964 • Fort Collins, CO 80525

114

## FCC LOWERS REQUIREMENTS — GET YOUR RADIO TELEPHONE LICENSE

FCC changes make obtaining a High-level Radio Telephone License much easier now. Eliminate unnecessary study with our shortcuts and easy to follow study material. Obtaining the General Radio Telephone License can be a snap! Sample exams, also section covering Radar Endorsement.

A small investment for a high-paying career in electronics.

\$19.95 ppd.

Satisfaction Guaranteed

SPI-RO DISTRIBUTING

P.O. Box 1538

Hendersonville, N. C. 28793

We now accept MC and VISA  
Give card #, exp. date, and signature



185







## Stuck with a problem?

Our TE-12P Encoder might be just the solution to pull you out of a sticky situation. Need a different CTCSS tone for each channel in a multi-channel Public Safety System? How about customer access to multiple repeater sites on the same channel? Or use it to generate any of the twelve tones for EMS use. Also, it can be used to access Amateur repeaters or just as a piece of versatile test equipment. Any of the CTCSS tones may be accessed with the TE-12PA, any of the audible frequencies with the TE-12PB. Just set a dip switch, no test equipment is required. As usual, we're a stickler for 1day delivery with a full 1 year warranty.

- Output level flat to within 1.5db over entire range selected.
- Immune to RF.
- Powered by 6-30vdc, unregulated at 8 ma.
- Low impedance, low distortion, adjustable sinewave output, 5v peak-to-peak.
- Instant start-up.

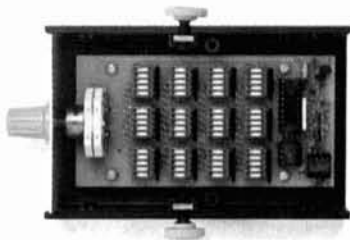

### TE-12PA

67.0 XZ	85.4 YA	103.5 1A	127.3 3A	156.7 5A	192.8 7A
71.9 XA	88.5 YB	107.2 1B	131.8 3B	162.2 5B	203.5 M1
74.4 WA	91.5 ZZ	110.9 2Z	136.5 4Z	167.9 6Z	
77.0 XB	94.8 ZA	114.8 2A	141.3 4A	173.8 6A	
79.7 SP	97.4 ZB	118.8 2B	146.2 4B	179.9 6B	
82.5 YZ	100.0 1Z	123.0 3Z	151.4 5Z	186.2 7Z	

- Frequency accuracy,  $\pm 1$  Hz maximum  $-40^{\circ}\text{C}$  to  $+85^{\circ}\text{C}$
- Frequencies to 250 Hz available on special order.
- Continuous tone

### TE-12PB

TEST-TONES:	TOUCH-TONES:	BURST TONES:
600	697 1209	1600 1850 2150 2400
1000	770 1336	1650 1900 2200 2450
1500	852 1477	1700 1950 2250 2500
2175	941 1633	1750 2000 2300 2550
2805		1800 2100 2350

- Frequency accuracy,  $\pm 1$  Hz maximum  $-40^{\circ}\text{C}$  to  $+85^{\circ}\text{C}$
- Tone length approximately 300 ms. May be lengthened, shortened or eliminated by changing value of resistor

**\$89.95**

**COMMUNICATIONS SPECIALISTS**

426 West Taft Avenue, Orange, California 92667  
(800) 854-0547/California: (714) 998-3021



Actual slow motion frames from Ham MasterTapes



1. Larry, N2NY, Lee, KA2RNV



2. Lee discharges cap

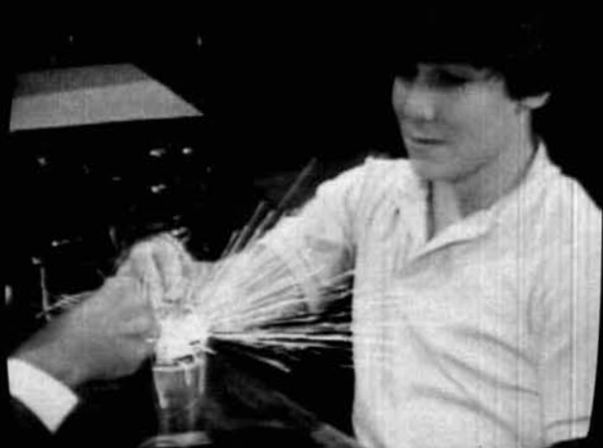

3. In slow motion it's dazzling



4. Wow. Can we see it again?

**You've never seen this, like this,  
before this!**

**And you can see it—in color—again and again  
when you own the N2NY Ham MasterTapes.**

Ever see a cap discharge in slow motion? You will on Ham MasterTapes. Ham MasterTapes can perform the dozens of complicated demonstrations necessary for a beginner's understanding of Ham Radio Theory.

Finally, a step-by-step course in Ham Radio Theory is available on color videotape. The Larry Horne N2NY Ham MasterTapes video course is a unique, effective teaching technique expertly produced by New York's leading professionals in studio and field videotape.

- Video Graphics highlight important details.
- Carefully worked-out demonstrations on video avoid the problem of getting complex gadgets to work on command in front of a class.
- Working examples of every ham radio component, device, or system covered in the FCC guide can be clearly understood.

The N2NY Ham MasterTapes give you a basic grasp of concepts that build theory background—not only for passing the FCC tests, but for understanding electronics.

The hobby has long needed better, clearer, high-tech teaching aids to help newcomers into our wonderful world of Ham Radio.

These six-hour tapes cover completely all the material needed to understand Novice and Tech/General Theory and operations, and include the new 200-question FCC syllabus used beginning September 1983.

Only \$199.95. Order direct and specify Beta or VHS format. Call or write: Larry Horne, N2NY

**Ham MasterTapes™**

THE N2NY HAM RADIO COURSE ON VIDEOTAPE

Ham MasterTapes  
136 East 31st Street  
New York, N.Y. 10016 212-673-0680.

# Clean up the radio/computer clutter.

**For less than \$250  
you can make your  
investment in yourself  
pay off!**

Chances are you have spent a couple thousand dollars on setting up a computer system that gets a lot of your work done. But sometimes it gets to be work to work at it.

I know that when I have to move two program manuals and a pencil holder to boot up the disk drive, it is work. When there is an unlabeled floppy (that I am going to identify some day) on top of the monitor and the business check-book is on top of the printer . . . and I will remember (I hope) before the next "report" comes through . . . that is work.

I found the annoyance of my own "computer clutter" was even worse than the extra work the disorder created. And that is when I started looking for some practical furniture for my computer set up. Since I had already spent a lot of money on the system itself, I was really dismayed when I found out how much it would cost to get a decent-looking desk or even a data table for my equipment. \$400 . . . \$500 . . . even more for a sleazy unit that looked like junk! In fact, it was junk! And it took a long time for me to find something that was really worth the money . . . and more.

A lot of my working day is spent with my computer, and I will bet a lot of your time is too. So I figure a "home" for my system—a housing that is good looking as well as efficient to work at—will pay off two ways:

1. Less work: an efficient and orderly layout will save me time and energy.
2. Personal satisfaction: good quality furnishings look better; they just plain feel better to work at too.

So imagine how good I felt to find the "Micro-Office" Work Center! These are fine pieces of computer system furniture that make my office-at-home as pleasant a place to work as it ought to be. And the



## MICRO-OFFICE WORK CENTER

biggest and best surprise is the low, low price for such good quality.

Here is what you get—all for only \$249.50 plus shipping.

- Mar-resistant work surface. Your choice of oak or walnut grained. Work surface height is adjustable to your keyboard, your chair, your height.
- Two shelves plus work surface extender. Both shelves tilt to lock in position so that monitor faces you—in a position that does away with screen glare squinting and neck craning forever. Retainer bar keeps equipment from sliding off shelf. Snap-in bookends hold reference manuals and programs.
- Strong, sturdy and steady. All-steel welded frame construction is concealed by top-quality wood grain surfaces with finished trim. Adjustable floor levelers included. The work center is really a piece of fine furniture.
- There is no risk in buying from us either. We will make a full refund of purchase

price plus shipping charges if you return the workcenter within 30 days for any reason whatsoever. In addition, the product is warranted for any defects in materials or construction for a full year from date of purchase. This is a no-risk investment in your own productivity and work efficiency that will pay off for years to come—even if you do not yet have a microcomputer of your own.

- Take your choice for your own work center decor:

Order 48-inch unit in walnut, #2KPO-945, or in oak, #2KPO-947. Only \$249.50 for each unit plus \$20.00 shipping charge. On orders for two or more units at the same time, shipping charge applies to only the first unit ordered. Shipment made UPS, so we cannot ship to post office box. Illinois residents please add \$15 per unit sales tax. Please allow 10 extra days for personal checks to clear. Sorry—at these special offer prices we cannot ship c.o.d. or bill direct.

**CALL TOLL FREE TODAY WHILE SUPPLIES LAST: 1-800/323-8064.**

**In Illinois call 1-312/251-5699. Or mail check with order to:**

### Micro-Mart Distributors

Dept. HR • 1131 Central Street • Wilmette, IL 60091

# HAM MART

Ham Radio's guide to help you find your local dealer

## California

### C & A ROBERTS, INC.

18511 HAWTHORN BLVD.  
TORRANCE, CA 90504  
213-370-7451  
24 Hour: 800-421-2258  
Not The Biggest, But The Best —  
Since 1962.

### FONTANA ELECTRONICS

8628 SIERRA AVENUE  
FONTANA, CA 92335  
714-822-7710  
714-822-7725  
The Largest Electronics Dealer in San  
Bernardino County.

### JUN'S ELECTRONICS

3919 SEPULVEDA BLVD.  
CULVER CITY, CA 90230  
213-390-8003  
800-882-1343 Trades  
Habla Espanol

## Connecticut

### HATRY ELECTRONICS

500 LEDYARD ST. (SOUTH)  
HARTFORD, CT 06114  
203-527-1881  
Call today. Friendly one-stop shopping  
at prices you can afford.

## Delaware

### AMATEUR & ADVANCED COMMUNICATIONS

3208 CONCORD PIKE  
WILMINGTON, DE 19803  
Delaware's Friendliest Ham Store.

### DELAWARE AMATEUR SUPPLY

71 MEADOW ROAD  
NEW CASTLE, DE 19720  
302-328-7728  
800-441-7008  
Icom, Ten-Tec, Microlog, Yaesu,  
Kenwood, Santec, KDK, and more.  
One mile off I-95, no sales tax.

## Florida

### AMATEUR ELECTRONIC SUPPLY

1898 DREW STREET  
CLEARWATER, FL 33575  
813-461-4267  
Clearwater Branch  
West Coast's only full service  
Amateur Radio Store.  
Hours M-F 9-5:30, Sat. 9-3

### AMATEUR ELECTRONIC SUPPLY

621 COMMONWEALTH AVE.  
ORLANDO, FL 32803  
305-894-3238  
Fla. Wats: 1 (800) 432-9424  
Outside Fla: 1 (800) 327-1917  
Hours M-F 9-5:30, Sat. 9-3

### AMATEUR RADIO CENTER, INC.

2805 N. E. 2ND AVENUE  
MIAMI, FL 33137  
305-573-8383  
The place for great dependable  
names in Ham Radio.

## Hawaii

### HONOLULU ELECTRONICS

819 KEEAUMOKU STREET  
HONOLULU, HI 96814  
(808) 949-5564  
Serving Hawaii & Pacific area for 51  
years. Complete lines of Amateur equip-  
ment, accessories and parts.

## Illinois

### ERICKSON COMMUNICATIONS, INC.

5456 N. MILWAUKEE AVE.  
CHICAGO, IL 60630  
312-631-5181  
Hours: 9:30-5:30 Mon, Tu, Wed & Fri;  
9:30-8:00 Thurs; 9:00-3:00 Sat.

## Indiana

### THE HAM SHACK

808 NORTH MAIN STREET  
EVANSVILLE, IN 47710  
812-422-0231  
Discount prices on Ten-Tec, Cubic,  
Hy-Gain, MFJ, Azden, Kantronics,  
Santec and others.

## Kentucky

### L & S RADIO

307 McLEAN AVENUE  
HOPKINSVILLE, KY 42240  
502-885-8071  
Ten-Tec, Azden, Ameritron Sales and  
Service.

## Massachusetts

### TEL-COM, INC.

675 GREAT ROAD, RTE. 119  
LITTLETON, MA 01460  
617-486-3400  
617-486-3040  
The Ham Store of New England  
You Can Rely On.

## Michigan

### ENCON PHOTOVOLTAICS

Complete Photovoltaic Systems  
27600 Schoolcraft Rd.  
Livonia, Michigan 48150  
313-523-1850  
Amateur Radio, Repeaters, Satellite,  
Computer applications.  
Call Paul WD8AHO

## Nevada

### AMATEUR ELECTRONIC SUPPLY

1072 N. RANCHO DRIVE  
LAS VEGAS, NV 89106  
702-647-3114  
Dale Porray "Squeak," AD7K  
Outside Nev: 1 (800) 634-6227  
Hours M-F 9-5:30, Sat. 9-3

### JUN'S ELECTRONICS

460 E. PLUMB LANE — 107  
RENO, NV 89502  
702-827-5732  
Outside Nev: 1 (800) 648-3962  
Icom — Yaesu Dealer

## NEW YORK

### ADIRONDACK ELECTRONICS, INC.

1991 CENTRAL AVENUE  
ALBANY, NY 12205  
Delaware's Friendliest Ham Store.

### BARRY ELECTRONICS

512 BROADWAY  
NEW YORK, NY 10012  
212-925-7000  
New York City's Largest Full Service  
Ham and Commercial Radio Store.

### VHF COMMUNICATIONS

915 NORTH MAIN STREET  
JAMESTOWN, NY 14701  
716-664-6345  
Call after 7 PM and save! Supplying all  
of your Amateur needs. Featuring ICOM  
"The World System." Western New  
York's finest Amateur dealer.

**Dealers:** YOU SHOULD BE HERE TOO!  
Contact Ham Radio now for complete details.



## Amateur Radio Dealer

### Ohio

**AMATEUR ELECTRONIC SUPPLY**  
28940 EUCLID AVE.  
WICKLIFFE, OH (CLEVELAND AREA)  
44092  
216-585-7388  
Ohio Wats: 1 (800) 362-0290  
Outside Ohio: 1 (800) 321-3594  
Hours M-F 9-5:30, Sat. 9-3

**UNIVERSAL AMATEUR RADIO, INC.**  
1280 AIDA DRIVE  
REYNOLDSBURG (COLUMBUS), OH  
43068  
614-866-4267  
Featuring Kenwood, Yaesu, Icom,  
and other fine gear. Factory author-  
ized sales and service. Shortwave  
specialists. Near I-270 and airport.

### Pennsylvania

**HAMTRONICS,**  
DIV. OF TREVOSE ELECTRONICS  
4033 BROWNSVILLE ROAD  
TREVOSE, PA 19047  
215-357-1400  
Same Location for 30 Years.

**LaRUE ELECTRONICS**  
1112 GRANDVIEW STREET  
SCRANTON, PENNSYLVANIA 18509  
717-343-2124  
Icom, Bird, Cushcraft, Beckman,  
Larsen, Hustler, Astron, Belden,  
Antenna Specialists, W2AU/W2VS,  
AEA, B&W, Amphenol, Saxton, J.W.  
Miller/Daiwa, Vibroplex.

**THE VHF SHOP**  
BOX 349 RD 4  
MOUNTAINTOP, PA 18707  
717-868-6565  
Lunar, Microwave Modules, ARCOS,  
Astron, KLM, Tama, Tonna-F9FT,  
UHF Units/Parabolic, Santec, Tokyo  
Hy-Power, Dentron, Mirage,  
Amphenol, Belden

### Texas

**MADISON ELECTRONICS SUPPLY**  
1508 MCKINNEY  
HOUSTON, TX 77010  
713-658-0268  
Christmas?? Now??

### Wisconsin

**AMATEUR ELECTRONIC SUPPLY**  
4828 W. FOND DU LAC AVE.  
MILWAUKEE, WI 53216  
414-442-4200  
Wisc. Wats: 1 (800) 242-5195  
Outside Wisc: 1 (800) 558-0411  
M-F 9-5:30  
Sat 9-3

## RTTY BOOKS

### RTTY TODAY

#### A Modern Guide to Amateur Radio Teletype

by Dave Ingram, K4TWJ

Brand New and Fully up-to-date. Dave Ingram is a noted RTTY enthusiast. His clear, concise writing style and a wealth of illustrations, diagrams and photos, make RTTY as easy as 1-2-3! Extensive coverage is given to using home computers for RTTY. Eleven chapters start with an overview of RTTY operation, then give you coverage of operating parameters, computers, equipment you can build, dedicated systems and four chapters on RTTY SWL'ing info. 135 pages. ©1984. 1st edition.

UE-AR Softbound \$8.95

### WORLD PRESS SERVICES

by Thomas Harrington

Tuning in to the different press services is the best way to keep abreast of all the latest news developments. Hundreds of news service teletype stations operate around the clock from all parts of the world. Stations are listed by time and frequency for easy locating. Also gives you plenty of helpful hints on the ins and outs of RTTY equipment and other "tricks of the trade." ©1983. 4th edition.

UE-PS Softbound \$8.95

### WORLD UTILITY FREQUENCY and CALL SIGN GUIDE — 3-30 MHz

8,000 frequencies, 4,000 different call signs, tabulated in an easy-to-use format. The first part of this book is arranged in an ascending frequency order starting at 3 MHz. Part two is a complete listing of abbreviations commonly used. Part three is comprised of one of the most up-to-date call sign listings along with common frequencies. There also is a complete listing of both Aeronautical and Maritime Mobile Service frequencies. Casual SWL'ing or looking for information from certain specific sources, this book should be in your personal library. ©1983. 1st edition.

UE-CS Softbound \$12.95

### RADIO TELETYPE PRESS BROADCASTS

Edited by Michiel Schaay

A convenient, easy-to-use listing of 1500 press broadcasts in all languages. This book is divided into two sections to enhance usability. Part one is a time order list of English, French, German, Spanish and Portuguese news bulletins. Part two contains a detailed time and frequency schedule for 56 different news agencies around the world as well as addresses. Foreign news agencies often provide an interesting, different slant to the world's news. Listening to them can provide a unique insight to the state-of-the-world's affairs. ©1983.

UE-PB Softbound \$12.95

Order any two books  
and deduct 10% from total  
(Shipping not included)

Please add \$2.50  
U.S. only shipping and handling.  
Foreign orders FOB Greenville.

**Ham Radio's Bookstore**  
Greenville, NH 03048

## MOSLEY...A Better Antenna... For New and Old

- \*EASY ASSEMBLY
- \*NO MEASURING
- \*ALL STAINLESS HARDWARE
- \*2 YEAR WARRANTY
- \*LOW SWR
- \*BUILT TO LAST

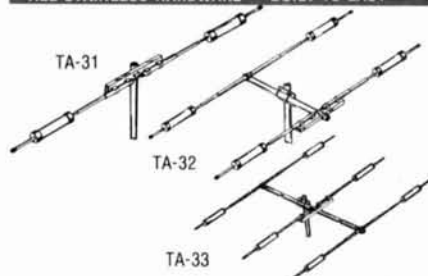

Whether you are just starting out or trying to complete the Honor Roll, Mosley offers a Full Line of Tri-Banders which will mechanically and electronically outperform the competition. For the new ham with limited space and pocket book, start with our TA-31 Jr. rotatable dipole. You can make our TA-31 Jr. into a 2 or 3 element as your needs increase.

If you start with the need to run higher power, then the TA-31 is for you. This also can be made into a 2 or 3 element beam as you expand your station.

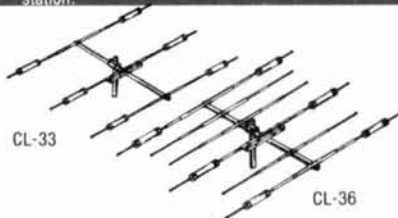

For the ham that wants a little more performance out of a Tri-Bander but is limited in room, then our CL-33 on a 18 foot boom is the way to go. For those that want MONO BAND performance out of a Tri-Bander, want to hear better, and be louder, the CL-33 is for you.

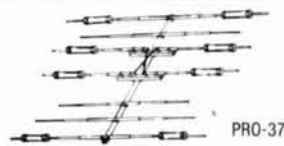

For the ham that wants to start right at the top, the PRO-37 is the antenna that will give you king of the hill performance. It is the broadest banded, highest power, best performing Tri-Bander in our line.

Compare ours before buying any other antenna. All stainless standard, all heavy telescoping aluminum elements which means better quality and no measurement. Ease of assembly gives you a quality antenna with consistent performance. Our elements are pre-drilled so you will get the same performance as we do. All of our Tri-Banders come with a 2 year warranty.

If you are a new ham and are not familiar with MOSLEY, ask an older ham about us or call the PRESIDENT of MOSLEY. He will be glad to explain why MOSLEY IS A BETTER ANTENNA.

These and other MOSLEY products are available through your favorite DEALER. Or write or call MOSLEY for the DEALER nearest you.

**Mosley Electronics, Inc.**

1344 BAUR BLVD. ST. LOUIS, MISSOURI 63132



# flea market



**RATES** Noncommercial ads 10¢ per word; commercial ads 60¢ per word **both payable in advance**. No cash discounts or agency commissions allowed.

**HAMFESTS** Sponsored by non-profit organizations receive one free Flea Market ad (subject to our editing) on a space available basis only. Repeat insertions of hamfest ads pay the non-commercial rate.

**COPY** No special layout or arrangements available. Material should be typewritten or clearly printed (**not** all capitals) and must include full name and address. We reserve the right to reject unsuitable copy. **Ham Radio** cannot check each advertiser and thus cannot be held responsible for claims made. Liability for correctness of material limited to corrected ad in next available issue.

**DEADLINE** 15th of second preceding month.

**SEND MATERIAL TO:** Flea Market, Ham Radio, Greenville, N. H. 03048.

**QSLs & RUBBER STAMPS** -- Top Quality! Card Samples and Stamp info — 50¢ — Ebbert Graphics 5R, Box 70, Westerville, Ohio 43081.

**"KT55"** Super DX sloper 80-10M only \$59.95. "KT5B" Multi-band dipole 160-10M only \$59.95. 2-KW roller inductor (28uh) \$47.50. Weather boot kit (PL-259) \$8.95 pp. Much more! Info available. Kilo-Tec, PO Box 1001, Oakview, CA 93022. Tel: 805-646-9645.

**WANTED:** Old RCA, Western Electric, tubes, speakers, amps. (713) 728-4343. Corb. 11122 Atwell, Houston, Texas 77096

**CUSTOM EMBROIDERED EMBLEMS** — Enameled pins, your design, low minimum, excellent quality, low prices, free booklet. A.T. Patch Co., Dept. 65, Littleton, NH 03561. (603) 444-3423.

**TRAVEL-PAK QSL KIT** — Converts post cards, photos to QSLs. Stamp brings circular. Samco, Box 203-c, Wynantskill, New York 12198.

**NH ALL-BAND QTH.** South slope/retreat, Crotched Mountain, Greenfield. 4 room lodge, separate bunkhouse. 920' elevation, 1200' from highway and power mains, paved access, privacy, 59 acres. \$95,000. Clarence Farr (W1WMK) Broker, Greenfield, NH 03047. (603) 547-2053.

## Foreign Subscription Agents for Ham Radio Magazine

Ham Radio Austria  
Karin Ueber  
Postfach 2454  
D-7850 Loerrach  
West Germany

Ham Radio Belgium  
Stereohouse  
Brusselsesteenweg 416  
B-9218 Gent  
Belgium

Ham Radio Canada  
Box 400, Goderich  
Ontario, Canada N7A 4C7

Ham Radio Europe  
Box 2084  
S-194 02 Upplands Vasby  
Sweden

Ham Radio France  
SM Electronic  
20 bis, Ave des Clairons  
F-89000 Auxerre  
France

Ham Radio Germany  
Karin Ueber  
Postfach 2454  
D-7850 Loerrach  
West Germany

Ham Radio Holland  
Postbus 413  
NL-7800 Ar Emmen  
Holland

Ham Radio Italy  
Via Pordenone 17  
I-20132 Milano  
Italy

Ham Radio Switzerland  
Karin Ueber  
Postfach 2454  
D-7850 Loerrach  
West Germany

Ham Radio England  
c/o R S G B  
Alma House  
Cranborne Road  
Potters Bar  
Herts EN6 3JW  
England

Holland Radio  
143 Greenway  
Greenside, Johannesburg  
Republic of South Africa

**RADIO ITEMS** before 1930 wanted. Buying battery operated radios, horn and cone speakers, radio tubes and parts, radio literature — books, catalogs, magazines, radio advertising signs, posters. Gary Schneider, 6848 Commonwealth Blvd., Parma Heights, Ohio 44130.

**QSL CARDS:** \$15.50/500, ppd. Free catalog. Bowman Printing, 743 Harvard, St. Louis, MO 63130.

**DIGITAL AUTOMATIC DISPLAYS** for FT-101's TS-520's, and most others. Six 1/2" digits. Write for information. Grand Systems, P.O. Box 2171, Blaine, Washington 98230. (604) 530-4551.

**SELL:** 40 year collection receiving tubes — dollar each. Antique molded mica transmitting capacitors, all sizes, voltages. Wanted to buy, machinist tools from retired toolmaker. W5QJT, PO Box 13151, El Paso, TX 79913.

**RUBBER STAMPS:** 3 lines \$4.50 PPD. Send check or MO to G.L. Pierce, 5521 Birdkale Way, San Diego, CA 92117. SASE brings information.

**FREE** catalog on new & used computers, hardware, key-boards, tapes, multiplexers, CRTs, etc. IN-X-Sales, Dept. B, Box 45, Tilton, NH 03276. (603) 286-3082.

**"THE SWAP LIST"** has bargains galore. Subscribe now! 6 months for \$4.00, 1 year only \$6.50. The Swap List, Box 988-H, Evergreen, CO 80439.

**ROM-116** for TRS-80 RTTY with 5 program tapes and instruction manuals. 1.3 version. \$200 or best offer. Ken Eaton, 6418 W. 78th St., Prairie Village, Kansas 66204.

**HAM RADIO MAGAZINE** Collection: Bound volumes 1969, 1970, 1971, 1972, 1973, 1974, 1975. In HR binders 1976, 1977, 1978, 1979. Loose copies 1980, 1981, 1982, 1983. Best offer for lot. W4UCH, P.O. Box 1065, Chautauqua, NY 14722. (716) 753-2654.

**FOR SALE:** Swan 350 transceiver w/ps \$250. SA2040 antenna tuner \$125. QF-1A audio filter \$50. Kantronics CW/RTTY interface for Vic-20 with programs board + cables \$135. Shipping included. Send money order. Package price \$500. Write Jim Howell, KA4EBW, 18 Dan St., Salisbury, NC 28144. (704) 637-0313 evenings.

**REPAIR, ALIGNMENT,** calibration. Collins written estimates \$25; non Collins \$50. K1MAN (207) 495-2215.

**MICROWAVE MIXERS.** Two new Watkins-Johnson M77C X-band DBM's. \$125 each. SMA or microstrip. Low noise, high isolation. Cost \$382 each. John Perlick, 7435 Brunswick, Brooklyn Park, MN 55443.

**CHASSIS** and cabinet kits. SASE K3IWK.

**NATIONAL RADIO CO** equipment manuals price list SASE. Dust covers, NCX 3 or NCX 5 plus NCX A, pair \$8.95 PP. Maximilian Fuchs, 11 Plymouth Lane, Swampscott, MA 01907.

**ELECTRON TUBES:** Receiving, transmitting, microwave... all types available. Large stock. Next day delivery most cases. Daily Electronics, 14126 Willow Lane, Westminster, CA 92683. (714) 894-1368

**HAM TRADER WEST** "Pink Sheets" 25 cents a word for subscribers, \$9 a year bimonthly. Canadians send U.S. funds, posted same day as U.S. from Canada. Others 50 cents a word, commercial 75 cents a word. Name address and phone free. Ham Trader West, Box 202, Lynden, Washington 98264.

**WANTED:** Cash paid for used speed radar equipment. Write or call: Brian R. Esterman, PO Box 8141, Northfield, Illinois 60093. (312) 251-8901.

**\$\$\$ SUPER SAVINGS** on electronics parts, components, supplies, and computer accessories. Free 40-page catalog for SASE. Get on our mailing list. BCD Electro, PO Box 830119, Richardson, TX 75083. Or call (214) 690-1102.

**WANTED:** Old microphones, remote mixers other mic related items. All pre-1935. Box Paquette, 107 E. National Avenue, Milwaukee, WI 53204.

**DELTA LOOP BOOM** for 10-20 meters. Lightweight, strong, quality boom with element brackets attached. Element kits available, or make up your own. Full details. D.L. Manufacturing, 485 Fifth Avenue, #1042, New York, NY 10017.

**STERLING SILVER** call sign jewelry pin or tack; \$11.95, alligator tie clip; \$19.95, all ppd. Info-SASE. Tom's Silver, PO Box 3758, Manchester, NH 03105.

**RECONDITIONED TEST EQUIPMENT** \$1.00 for catalog. Walter, 2697 Nickel, San Pablo, CA 94806.

**FOX-TANGO** Newsletters -- Since 1972, the prime source of modifications, improvements, and repair of Yaesu gear, free to Club members. Calendar year dues still only \$8 U.S., \$9 Canada, \$12 elsewhere. Includes five year cumulative index by model numbers, or send \$1 for index and sample Newsletter. Fox Tango Club, Box 15944, W. Palm Beach, FL 33416.

**RTTY-EXCLUSIVELY** for the Amateur Teleprinter. One year \$7.00. Beginners RTTY Handbook \$8.00 includes journal index. P.O. Box RY, Cardiff, CA 92007.

**IMRA** International Mission Radio Assn. helps missionaries — equipment loaned, weekday net, 14.280 MHz, 2-3 PM Eastern. Br. Frey, 1 Pryer Manor Rd., Larchmont, NY 10538.

**"HAMS FOR CHRIST."** Reach other Hams with a gospel tract sure to please. Clyde Stanfield, WA6HEG, 1570 N. Albright, Upland, CA 91786.

**TENNATEST** — Antenna noise bridge — out-performs others, accurate, costs less, satisfaction guaranteed, \$41.00. Send stamp for details, W8URR, 1025 Wildwood Road, Quincy, MI 49082.

**WANTED:** Early Hallicrafter "Skyriders" and "Super Skyriders" with silver panels, also "Skyrider Commercial", early transmitters such as HT-1, HT-2, HT-8, and other Hallicrafter gear, parts, accessories, manuals. Chuck Dachis, WD5EOG, The Hallicrafter Collector, 4500 Russell Drive, Austin, Texas 78745.

**VERY in-ter-est-ing!** Next 4 issues \$2. Ham Trader "Yellow Sheets", POB356, Wheaton, IL 60189.

**FOR SALE:** B&K model E-200D RF signal generator \$280.00; electronic navigation model 310L 250KHz-110 MHz RF linear amplifier \$500.00; Leader model LSG-231 FM stereo signal generator \$300.00; Eico model 150 solid state signal tracer \$100.00; Lafayette Pip-Speak stereo speakers \$50.00. Leader VLM model LP-70B 20k ohm per volt \$40.00; Minolta SRT-200 35mm camera with UV filter, 50mm lens and case \$125.00; RF Power Labs model V350 2 meter 350W linear amp. with fan cool \$800.00; Monroe simplex autopatch, commercial quality, with various remote functions with Yaesu CPU-2500 2 meter memorizer radio \$125.00. TR-110 B&K isopack isolator transformer \$100.00. Mitchell Rakoff, 114-41 Queens Blvd., Suite 148, Forest Hills, NY 11375 (212) 591-0002.

## Coming Events ACTIVITIES "Places to go..."

**ALABAMA:** The Huntsville Hamfest, Saturday and Sunday, August 18 and 19, Von Braun Civic Center, Huntsville. No admission charge. Exhibits, forums, air-conditioned indoor flea market and non-ham activities. Tours of the Alabama Space & Rocket Center available. A limited number of camp sites with hookups at VBCC. Reserved flea market tables available \$4/day. Talk in on 34/94. For information: Huntsville Hamfest, 2804 S. Memorial Parkway, Huntsville, AL 35801.

**WYOMING:** The fifth annual High Plains Ham Roundup, sponsored by the Northern Colorado ARC, University of Wyoming ARC and Shy-Wy ARC, September 7, 8 and 9, Medicine Bow National Forest, Yellow Pine Campground, 35 miles west of Cheyenne. Campfire cookout and bring-your-own covered dish supper Saturday with singalong music and entertainment by regional talent. Barbequed hamburgers and refreshments provided by the committee. Giant tailgate swapfest, transmitter hunt and technical displays. No registration fee. Modest Forest Service charge for campers. Talk in on 22/82 and 25/85. For information: W7CGK, 1321 E. 22 Street, Cheyenne, WY 82001.

**RADIO EXPO '84** sponsored by the Chicago FM Club, Saturday and Sunday, September 22 and 23, Lake County Fairgrounds, Rt. 120 & 45, Grayslake, IL. Major manufacturers and gigantic outdoor flea market. Flea market opens 6 AM Exhibits 9 AM. Free parking and overnight camping. Reserve indoor flea market \$5/day. Tickets \$3.00 advance, \$4.00 at gate, good for both days. Seminars, technical talks and ladies programs. Talk in on 146.1676. SASE to Radio Expo '84, Box 1532, Evanston, IL 60204 or (312) 582-6923.

**FLORIDA:** The Platinum Coast Amateur Radio Society's annual Hamfest, September 8 and 9, Melbourne Auditorium Melbourne. Swap tables, meetings, forums, awards, tailgating. For information or reservations: PCARS, PO Box 1004, Melbourne, FL 32901.

**ONTARIO, CANADA:** The Radio Society of Ontario's 16th annual Convention, October 5, 6 and 7, Westin Hotel, Ottawa Friday night eyeball and dance. Saturday and Sunday technical sessions, demonstrations and commercial exhibits. Sat urday night banquet and dance. For information: RSO Convention Committee, PO Box 15806 Station "F", Ottawa Ontario K2C 3S7.

**PENNSYLVANIA:** The 47th annual South Hills Brasspounder and Modulators Hamfest, August 5, 9 AM to 4 PM, South Campus of the Community College of Allegheny County, Pittsburgh. Tickets \$3 each or 2/\$5. Indoor/outdoor flea market space available. Food and refreshments available. Free parking. Talk in on 146.13/73 and 146.52 simplex. For information: Jack B. Wood, 448 Jenne Dr., Pittsburgh, PA 15236

**PENNSYLVANIA:** Change of location for the Mid-Atlantic ARI Hamfest, August 12. (See announcement in July HR.) It will be held at the Bucks County Drive-in, Route 611, Warrington

**MINNESOTA:** The St. Cloud Amateur Radio Club's annual Hamfest, Sunday, August 12, 8 AM to 4 PM, Sauk Rapids MI

icipal Park, Sauk Rapids. Talk in on 146.34/94. For information: St. Cloud ARC, PO Box 141, St. Cloud, MN 56302.

**EW JERSEY:** The 25th GCARC Ham/Comfest, sponsored by the Gloucester County ARC, August 26, 8 AM to 4 PM, Gloucester County College, Sewell. Admission \$2.00 advance, 2.50 at door. Tailgating \$3.00 per space. Seminars, contests, computer demos, flea market, refreshments. Official VEC testing center, testing Novice thru Extra. No pre-registration necessary: 610 forms available. Talk in on 147.78/18, 146.52 simplex, 223.36/224.96. For information or reservations: Mill Gold-an, K3WIL, 801 Crown Point Rd., Westville, NJ 08093. (609) 56-0500 or John M. Fisher, K2JF, PO Box 370, Pitman, NJ 3071. (609) 589-2318.

**IWA:** The Des Moines Radio Amateur Association's Ham Computerfest, August 19, 9 AM to 5 PM, Veteran's Memorial auditorium, Des Moines. Donation \$3.00 advance, \$4.00 at door. Expanded flea market, Amateur and computer dealers, assignment tables. Refreshments available. Talk in on 16.22/82 and 440.5. For information and reservations: Bob Jucker, KD0EO, PO Box 3711, Urbandale, IA 50322 (515) 76-4415 or Louis Seibert, N0ELI, 7515 Roseland, Urbandale, IA 50322 (515) 276-0272.

**IAINE:** The 1984 Windsor Hamfest, Saturday, September 8, Windsor Fairgrounds. Flea market, programs, speakers, distributors, light meals and the traditional Saturday bean and asserole supper. Gate donation only one dollar. Camping available Friday and Saturday nights. Talk in on 146.22/82 repeater. For information: Don Hanson, N1AZH, RFD #2, Box 678, Greene, Maine 04236. (207) 946-7557.

**INDIANA:** The Tippecanoe Amateur Radio Association's 13th annual Hamfest, Sunday, August 19, Tippecanoe County Fairgrounds, Teal Road and 18th Street, Lafayette. Grounds open 7 AM. Tickets \$3.00. Large flea market, dealers, refreshments and fun. Talk in on 137/3 or 52. For tickets or information: Lafayette Hamfest, Route 1, Box 63, West Point, IN 7992.

**KENTUCKY:** The Central Kentucky ARRL Hamfest, sponsored by the Bluegrass Amateur Radio Society, Sunday, August 12, 8 AM to 5 PM, Scott County High School, Longlick road and US 25, Georgetown. Tech forums, awards, exhibits. C facilities. Free outside flea market space. Tickets \$3.50 advance and \$4.00 at gate. For information or tickets: Edward Bono, WA4ONE, P.O. Box 4411, Lexington, KY 40504.

**KLAHOMA-KANSAS State Line Area:** Great Salt Plains 2nd annual Hamfest, August 26, 9 AM to 5 PM, Community Building, south side of Great Salt Plains Lake. Tech forums, meetings, free swap tables, refreshments, Novice exams and noon ooluck dinner. Overnight camping and RV hookups at Lakes tate Park. Talk in on 147.90. 30 Salt Plains Repeater. For information: Steven Walz, WA5UTO, Box 222, Cherokee, OK 3728. (405) 596-3487.

**EW JERSEY:** The Ramapo Mountain ARC, WA2SNA, presents its 8th annual flea market August 18, Oakland American Legion Hall, 65 Oak St., Oakland (20 miles from GW ridge). Admission \$1.00. Non-ham family members free. In-or tables \$6.50. Tailgating \$3.00. Talk in on 147.49/146.49 nd 52. For information: Tom Risseeuw, N2AAZ, 63 Page Dr., Oakland, NJ 07436. 337-8389 after 6 PM.

**MISSOURI:** The St. Charles ARC's Hamfest '84, August 26, t. Charles City Hall Complex. Barbeque provided by the Harvester Lions. Nearby Riverfront Park and historic south main treet area. General admission \$1.00. Talk in on 146.07/67 nd 52 simplex. For information: Ron Ochu, K0AZ, 1914 N. th St., St. Charles, MO 63301.

**IRGINIA/WEST VIRGINIA:** The Bluefield Hamfest, Computer Satellite TV Fair, Sunday, August 26, 9 AM to 3 PM, Brush-rk Army-Civic Center, 1 mile north of Bluefield, West Vir-inia on US 52. Sponsored by the East River ARC. Admis-sion \$3.00. Children under 12 free. Large indoor flea market nd other activities. Paved parking, food on site. Talk in on 44.89/145.49 and 146.52. For information: Don Williams, JA4K, 412 Ridgeway Drive, Bluefield, VA 24605.

**TENNESSEE:** The Short Mountain Repeater Club is spons-oring the Lebanon Hamfest, Sunday, August 26, Cedars of Leb-non State Park, US 231, Lebanon. Outdoors only. Bring your wn tables. Food and drink available. Talk in on 46.31/146.91. For information: Morris Duke, W4WXQ, 210 isspayne Drive, Donelson, TN 37214.

**PENNSYLVANIA:** The Uniontown ARC (W3PIE) will hold its 5th annual Gabfest, Saturday, September 8, Club grounds, 14d Pittsburgh Road off Rt. 5 & 119 bypass, Uniontown. Free offee, free parking, free Swap & Shop with registration of 3.00 each, 2/\$5.00. Good food at refreshment stand. Talk in on 147.645-.045 & 144.57-.17. For information: John Cer-ak, WB3DOD, UARC Gabfest Committee, PO Box 433, lepublic, PA 15475. (412) 246-2870.

**PENNSYLVANIA:** The Central Pennsylvania Repeater s-sociation's 11th annual Hamfest/Computerfest, August 26, lershey. Adjacent to "Hersheypark" Chocolate town VA. registration \$3.00. Wives and children free. Special reduced mmission to Hersheypark for families of registrants. Large do-or dealer and flea market area. 10' indoor spaces \$8 each. ' tables \$4 each. Single electric plugs \$1 each. Large out-

door tailgating area. Refreshments available. Talk in on 145.47, 146.76 and 146.52. For information: Timothy R. Fanus, WB3DNA, 6140 Chambers Hill Road, Harrisburg, PA 17111. (717) 564-0897 (Noon to 8 PM).

**MICHIGAN:** The Grand Rapids Amateur Radio Association's annual Swap and Shop, Saturday, September 15, Hudson-ville Fairgrounds. Indoor sales area and outdoor trunk swap area. Gates open 8 AM. Talk in on 146.16/76. For informa-tion: Grand Rapids ARA, PO Box 1248, Grand Rapids, MI 49501.

**PENNSYLVANIA:** The Tioga County Amateur Radio Club's 8th annual Hamfest, Saturday, August 25, Island Park, Bloss-burg. 9 AM to 5 PM. Flea market, dealers, traders, computer demo, QSL contest, transmitter hunt, XYL and Harmonic pro-grams, RC airplanes and more. Talk in on 146-19/79, 146-52/52 and CB. Admission \$3.00. XYLs and kids free. For information: Carl E. Kimble, WB3EUE, PO Box 37, Cowan-esque, PA 16918. (814) 367-5345.

**IOWA:** The Iowa 75 Meter Net will sponsor a Hamfest and picnic, Sunday, August 26, W K W Park, North of Hampton. A potluck meal at noon followed by a short program. Talk in on Mason City 146.15-65. For information: WD0FWB or WB0JFF.

**INDIANA:** The Marshall County Amateur Radio Club's annual Hamfest, Sunday, August 26, 8 AM to 2 PM, Marshall Coun-ty 4H Fairgrounds, Argos. All kinds of radio gear. Dealer tables available — 8/\$5. Good food and drink. Ladies' activities. Talk in on 146.52 simplex. Tickets \$2.00 advance; \$3.00 at door. For information: Marshall County ARC, PO Box 151, Plymouth, IN 46563 or call Bob Nellans, KB9DE (219) 892-5224.

## OPERATING EVENTS

"Things to do..."

**AUGUST 18-19:** The Bergen Amateur Radio Association, Paramus, New Jersey, will operate special event station, K2TM, from 1500 to 2400Z to celebrate the Club's 21st anni-versary. Certificate for large SASE and QSL via K2UFM, 31 Forest Drive, Hillsdale, NJ 07642.

**AUGUST 18-19:** The Cascades Amateur Radio Society (CARS) in conjunction with the Michigan Space Center, Jack-son, Michigan, will operate WB8CSO during Space Day ac-tivities. 0000 GMT August 18 through 1700 GMT August 19. For a special Space Day certificate, send log info and \$1.00, to cover postage and materials, to CARS, Space Day '84, PO Box 512, Jackson, MI 49204.

**SEPTEMBER 8:** The West Alabama Amateur Radio Society (WAARS) will operate the 2nd annual special event station, KE4TN, from the campus of the University of Alabama, 1300Z to 2400Z, to commemorate the great college football coach, Paul 'Bear' Bryant. The Club will offer a handsome commem-orative certificate to any station worked. Send \$1 and a large SASE to: West Alabama ARS, PO Box 1741, Tuscaloosa, AL 35403.

**AUGUST 11-13:** 25th Annual New Jersey QSO Party. Spon-sored by the Englewood Amateur Radio Association, Inc. From 2000 UTC Saturday, August 11 to 0700 UTC Sunday, August 12 and 1300 UTC Sunday, August 12 to 0200 UTC Monday, August 13. Phone and CW considered same contest. Sug-gested frequencies: 1810, 3535, 3900, 7035, 7135, 7235, 14035, 14280, 21100, 21355, 28100, 28610, 50-50.5, and 144-146. Exchange: QSO number, RST, and QTH (ARRL section or country). New Jersey stations send county for their QTH. Logs and comments to: Englewood Amateur Radio Association, Inc., PO Box 528, Englewood, NJ 07631-0528. Include a #10 SASE for results.

**SEPTEMBER 9-15:** The Southern Counties Amateur Radio Association (SCARA) is planning to have a special events sta-tion during the Miss America Pageant. Check September Ham Radio for details.

# UHF/VHF BOOKS

## THE UHF COMPENDIUM

by K. Weiner, DJ9HO

This 413 page book is an absolute must for every VHF and UHF enthusiast. Special emphasis has been placed on state-of-the-art techniques. Author Weiner fully describes test equipment, alignment tools, power measuring equipment and other handy gadgets. All of the projects and designs have been tested and proven and are not engineer's pipe dreams. Antennas are also fully covered with a number of easy-to-build designs as well as large mega-element arrays. ©1980.

KW-UHF Softbound \$23.95

## VHF-UHF MANUAL

by G.R. Jessop, G6JP

This new, revised 4th edition is jam-packed with cir-cuits, antennas, converters, cavity amplifiers and much, much more. Practical theory and construction projects cover from 70 MHz to 24 GHz. The chapter on Microwaves has been expanded to 83 state-of-the-art pages. Receiver and transmitters for all VHF and UHF bands are covered in 181 pages. The bal-ance of this book contains information on propaga-tion, tuned circuits, space communications, filters, test equipment, antennas, plus a handy easy-to-use data section. Equipment designed for the British 4 meter band can be adapted fairly easily to the U.S. 6 meter allocation. ©1983, 512 pages, 4th edition.

RS-VH Hardbound \$17.50

## VHF RADIO PROPAGATION

by J. D. Stewart

Baffled by VHF propagation? It's not a mystery if you have a copy of this book. J.D. Stewart explains in detail propagation mechanisms such as atmos-pheric ducting, scattering, auroral reflections and ionized meteor trails. You also learn how to observe the Sun and evaluate weather conditions so you can predict favorable propagation conditions. ©1982, 112 pages, 2nd edition.

NO-PH Softbound \$4.95

## VHF HANDBOOK

by W9EGQ and W6SAI

Contains all the latest information for VHF operation. Antenna design and construction from 50-432 MHz is fully covered with proven practical design infor-mation. You also get a complete rundown on FM theory, design and plenty of helpful hints and tips. In the construction section, the authors detail how to build low noise, high performance converters, transceiv-ers, amplifiers and plenty of other pieces of interest-ing equipment. This book is a must for both the be-ginner and expert in VHF communications. ©1974, 336 pages, 3rd edition.

RP-VH Softbound \$11.95

Please add \$2.50 for shipping.

## HAM RADIO'S BOOKSTORE

Greenville, NH 03048

## ANTI-STATIC DUST COVERS

for New & Old Model Amateur Radios, Computers, Disk Drives, also Custom Made. Over 1 Million in use. Send for Brochure.

Radio Covers Available:

Alpha	Halicrafters	ICOM	Panasonic
Bearcat	Heath	Kenwood	Robot
Collins	Henry	MJF	Swan
Dentron			Ten-Tec
Drake			Yaesu

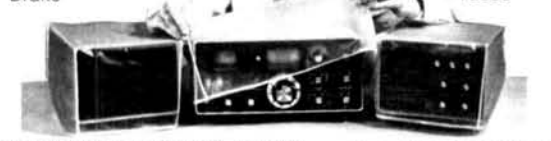

BIRCH HILL SALES, P.O. Box 296, Peterborough, NH 03458 Tel. (603) 924-7959

122

**Get Your Best Deal . . .**  
**Then CALL US . . . TOLL FREE!**

**1-800-238-6168** (In Tennessee, call 901-683-9125)

**KENWOOD**  **ICOM**

**AUTHORIZED DEALER FOR:** Kenwood, ICOM, Drake, Ten-Tec, Santec, MFJ, Astron, AEA, Mirage, B&W, Hustler, Cushcraft, Larsen, Hy-Gain, and others. . . **PLUS CURRENT USED GEAR**

When you call, talk to a Qualified Ham Operator! Ask for MARSHALL, KU4O, or BILL, W4TNP

**WE TRADE!**

**Call us for a free appraisal!**

After the sale, it's the service that counts!

## Memphis Amateur Electronics, Inc.

1465 Wells Station Rd., Memphis, TN 38108

**Store Hours:**  
Monday-Friday, 9 to 5,  
Saturday 9 to 12  
(Central Time)



✓ 157

## WARNING

SAVE YOUR LIFE OR AN INJURY

Base plates, flat roof mounts, hinged bases, hinged sections, etc., are not intended to support the weight of a single man. Accidents have occurred because individuals assume situations are safe when they are not.

Installation and dismantling of towers is dangerous and temporary guys of sufficient strength and size should be used at all times when individuals are climbing towers during all types of installations or dismantlings. Temporary guys should be used on the first 10' or tower during erection or dismantling. Dismantling can even be more dangerous since the condition of the tower, guys, anchors, and/or roof in many cases is unknown.

The dismantling of some towers should be done with the use of a crane in order to minimize the possibility of member, guy wire, anchor, or base failures. Used towers in many cases are not as inexpensive as you may think if you are injured or killed.

Get professional, experienced help and read your Rohn catalog or other tower manufacturers' catalogs before erecting or dismantling any tower. A consultation with your local, professional tower erector would be very inexpensive insurance.

Paid for  
By the  
Following:  
**ROHN®**  
P.O. Box 2000  
Peoria, IL 61656

✓ 127

**EXCITING NEW PROGRAM**  
To TRAIN You  
With . . . SOUND . . . To Increase  
Your Code Speed To Any Level!!  
Unique method helps you copy fast  
and easy.

Computer Programs for IBM PC and all compatibles:  
Complete Menu and Six Programs

. . . . \$19.95

Or:  
Cassette Tapes [Set of Three 60 Min. Tapes]

. . . . \$19.95

Send Money Order to avoid C.O.D. charges:

PM-100 Software Group  
c/o Clearwater Computer Center Inc.  
3447 U.S. 19 N.  
Clearwater, FL 33519

(813) 785-8022  
KB4AAX

**SAY YOU SAW IT  
IN  
HAM RADIO**

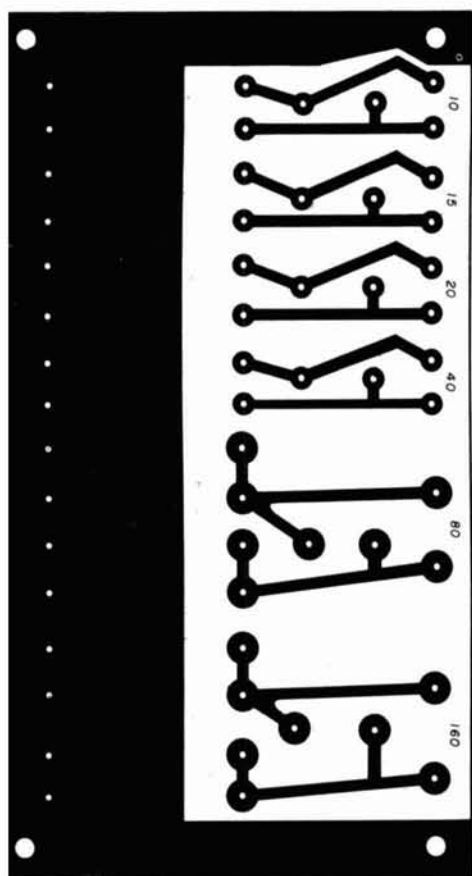

**A** RF input

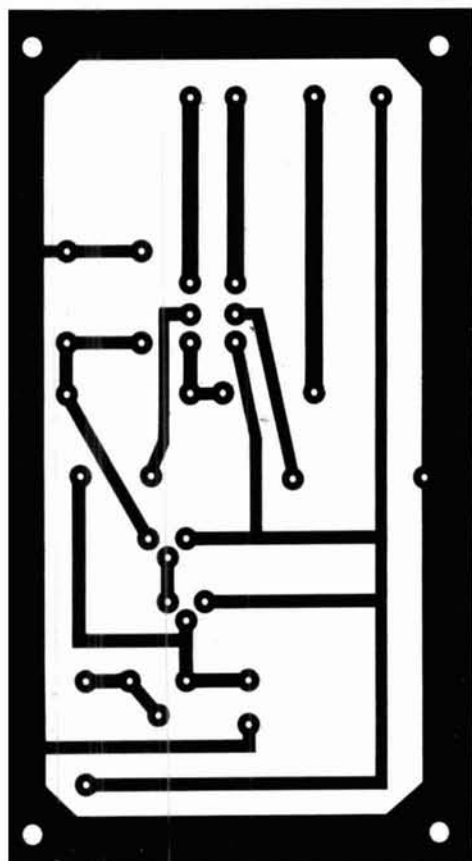

**E** Timer module

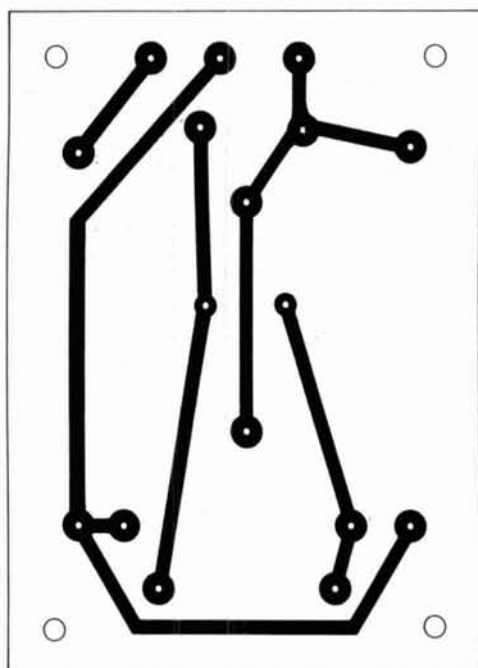

**B** Bias module

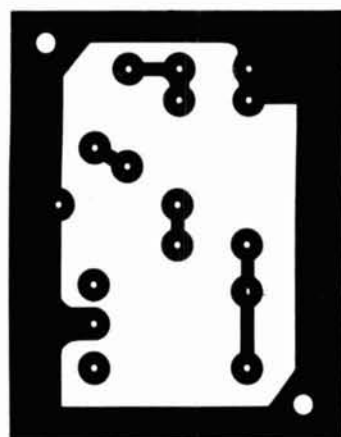

**C** ALC module

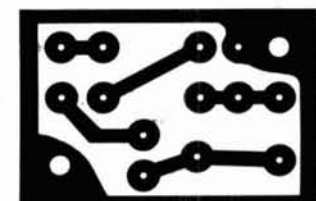

Filament voltage meter module

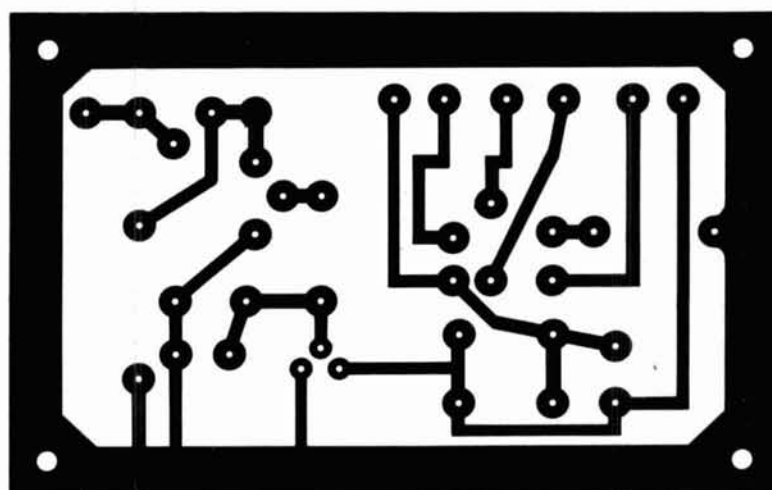

**D** Grid trip module

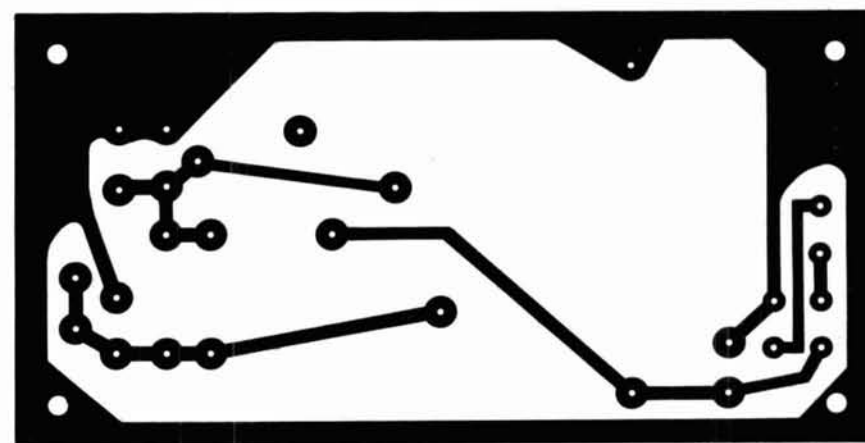

**F** 26 VDC regulated power supply



# Advertisers check-off

... for literature, in a hurry — we'll rush your name to the companies whose names you "check-off"

Place your check mark in the space between name and number. Ex: Ham Radio  234

Accessory Spec. .... 101	MHz Elec. .... 154
Ace Comm. .... 102	Madison .... 155
ADM .... 103	Maggiore .... 156
AEA .... 104	Memphis Amateur Elec. .... 157
ARR .... 106	Meshria .... 158
All Comm. .... 108	Micro-Mart * .....
All Elec. .... 107	Micro Systems .... 159
Alpha Delta .... 109	Microwave Filter ..... 160
Aluma .... 110	Midwest .... 161
Amateur Wholesale ..... 111, 112	Mirage .... 162
ARRL .... 113	Missouri Radio .... 163
Analog Tech. .... 114	Morning Dist. .... 164
Astron .... 115	Mosley .... 165, 166, 167
Austin Antenna .... 116	NCG .... 168
B & W * .....	Nail Co. .... 169
Barry * .....	Nampa .... 170
Bauman .... 121	Nemal .... 171
B.G. Micro .....	Nevada Sat. .... 172
..... 117, 118, 119	NEV ..... 173
BHCo .... 120	P.C. Elec. .... 174
Birch Hill .... 122	Pro Search .... 175
Buckmaster .... 123	RF Enterprises .... 176
Butternut * .....	RF Products .... 177
C & A Roberts .... 124	Callbook .... 178
Ceco .... 125	Radio Expo * .....
CES .... 126	Ramsey .... 179
Clearwater Computer .... 127	Robot .... 303
Coaxial Dynamics .... 128	Roensch .... 180
Comm. Concepts .... 129	Sartori .... 181
Comm. Spec. .... 130	Sat. TV Mag. .... 182
Computer Trader .... 131	Spectrum Comm. .... 306
Connect Systems ..... 132, 301	Spectrum Inter. .... 183
Dokay .... 133	Spectrum West .... 184
Doppler .... 134	Spi-Ro Dist. .... 185
Drake * .....	Starfinder .... 186
Dynetic Systems .... 135	TE Systems .... 187
Encomm .... 136	TNT Radio .... 188
Eng. Cons. .... 137	Telex * .....
Fluke * .....	Tel-tone .... 189
GLB Elec. .... 138	Texas Towers .... 190
GMB Systems * .....	UNR Rohn * .....
Ham Master Tapes .... 139	Ungar .... 304
HRB .... 140	Univ. Amateur Radio * .... 307
Hamtronics, N.Y. .... 141	Universal Elec. .... 191
Handi-Tek .... 142	University Microfilms * .....
Harvey Radio .... 143	URDC .... 308
Heath .... 144	VHF Comm. .... 192
Herry .... 145	Vanguard .... 193
Hewlett-Packard .... 146	Varian .... 194
Icom .... 147, 148, 302	Vector Radio .... 195
J & J Satellite TV .... 149	Webster Comm. .... 196
Jini Micro-Systems .... 305	Westcom .... 197
KLM .... 150	Western Elec. .... 198
Kantronics .... 151, 152	Williams .... 199
Kenwood * .....	World View .... 200
MFJ .... 153	Yaesu .... 201

\*Please contact this advertiser directly.

Limit 15 inquiries per request.

## August 1984

Please use before September 30, 1984

Tear off and mail to

HAM RADIO MAGAZINE — "check off"

Greenville, N. H. 03048-0498

NAME .....

CALL .....

STREET .....

CITY .....

STATE .....ZIP .....

# MADISON Electronics Supply

1508 McKinney  
Houston, Texas 77010

Call for Quotes  
713-658-0268

### COMPUTER CORNER

This month Madison Electronics Supply has two package specials for those of you that are interested in getting into the world of RTTY/AMTOR. Both of these packages include full function Morse, Baudot, ASCII and AMTOR modes of operation.

**Package 1** includes a self-contained unit that plugs directly into your Commodore 64 and a spectrum analyzer type tuning indicator that is as good as a scope for tuning.

AEA MP-64/2 TU & Software	retail 239.95
AEA TI-1 tuning indicator	retail 119.95
AEA AC-1 12VDC power supply	retail 19.95
One Mic Connector 4 or 8 pin	retail 4.95
<b>TOTAL \$384.80</b>	

**PACKAGE SPECIAL! \$289.95 YOU SAVE \$\$\$**

**Package 2** is the highly acclaimed CP-1 TU with the new MBA-TOR software, a high performance package for the more serious operator.

AEA CP-1 TU	retail 239.95
AEA MBA-TOR Software for C-64	retail 119.95
AEA TI-1 Tuning Indicator	retail 119.95
One Mic Connector 4 or 8 pin	retail 4.95
<b>TOTAL \$484.80</b>	

**PACKAGE SPECIAL! \$369.95 YOU SAVE \$\$\$**

MADISON STOCKS ALL THE AEA PRODUCT LINE... PLEASE CALL FOR PRICES... EXAMPLES:

CP-1.....Computer Patch Interface.....	199.95
CP-1/20.....above w/MBATEX VIC-20.....	239.95
CP-1/64.....above w/MBATEX C-64.....	239.95
MP-20.....MICROPATCH Hardware Software.....	149.95
MP-64.....as above for COM-64.....	149.95
MBATEX Software.....VIC-20 & COM-64.....	89.95
MBA-TOR Software.....COM-64.....	99.95
MARSTEXT MARS Software VIC-20, COM-64.....	89.95
PLUS Software for APPLE, IBM, PC, KAY-PRO, TRS-80, MOD III & IV, and HEATH H-89.....	

...KANTRONICS Has A New Product!!.....UTU.....

The Universal Terminal Unit works with any computer that has a RS-232 port. Contains the terminal unit and the software to work CW, RTTY, ASCII and AMTOR. All you need is a terminal communication program to drive the unit and a 12VDC power supply.

**MADISON HAS IT IN STOCK!! .....189.95**

MADISON STOCKS THE KANTRONICS LINE—CALL FOR PRICES.....EXAMPLES:

INTERFACE II.....	239.95
HAMTEXT.....VIC-20.....COM-64.....	89.95
AMTORSOFT.....VIC-20.....COM-64.....	79.95
HAMSOFTE.....VIC-20.....	39.95
PLUS Many Other Items In Stock. CALL for INFO.....	

.....HAL.....

Most Items In Stock Including The New ARQ-1000 AMTOR Unit.....Call For Current Prices.....

**SUPER CLOSEOUT SPECIAL!!!!**.....

AEA AMT-1 Includes CW board.....	359.95
AEA MBA-RC.....	259.95

### DON'S CORNER

In the last couple of years we have all seen some of the most advanced equipment that has ever been built offered to the amateur market. Most of this new gear is capable of computer control, and is completely solid state. With all of the fuss about the features and the advertising by the manufacturers, we all seem to have forgotten two of the most reliable and long term rigs on the market, the KENWOOD TS-530SP and TS-830S. Both of these rigs have been around for quite a while and offer excellent design, features, accessories and most of all, reliability. Madison maintains a stock of these fine rigs at all times. When getting ready to upgrade or start a station give us a call about these two fine rigs, the KENWOOD TS-530SP and TS-830S. Be sure to read the COMPUTER CORNER this month as we have two package deals for RTTY/AMTOR equipment. Thanks, and see you next month.

1-800-231-3057

# Advertisers Index

Accessory Specialties .....	130
Ace Communications .....	56
ADM .....	42
AEA .....	56
Advanced Receiver Research .....	75
All Comm. ....	62
All Electronics .....	54
Alpha Delta Communications .....	100, 101
Aluma Tower Co. ....	86
Amateur Wholesale Electronics .....	15, 105
American Radio Relay League .....	67
Analog Technology .....	130
Astron Corp. ....	66
Austin Custom Antenna .....	119
Barker & Williamson .....	121
Barry Electronics .....	85
Bauman Sales .....	56
B.G. Micro .....	49, 50, 51
BHCo .....	76
Birch Hill Sales .....	137
Buckmaster Publishing .....	76
Butternut Electronics .....	71
C & A Roberts, Inc. ....	61
Ceco .....	70
CES .....	1
Clearwater Computer Center .....	138
Coaxial Dynamics, Inc. ....	76
Communications Concepts, Inc. ....	75
Communications Specialists .....	131
Computer Trader Magazine .....	90
Connect Systems .....	96
Dokay Computer Products, Inc. ....	94, 95
Doppler Systems .....	123
R.L. Drake Co. ....	16, 39
Dynetic Systems .....	31
Encomm, Inc. ....	143
Engineering Consulting .....	86
John Fluke Manufacturing Co., Inc. ....	144
GLB Electronics .....	92
GMB Systems .....	93
Ham Master Tapes .....	132
Ham Radio's Bookstore .....	12, 70, 74, 92, 137
Hamtronics, NY .....	8, 9
Handi-Tek .....	122
Harvey Radio .....	48
Heath Company .....	71
Henry Radio .....	25
Hewlett-Packard .....	34
Icom America, Inc. ....	Cover II, 129
J&J Satellite TV Systems .....	62
KLM Electronics .....	28
Kantronics .....	68, 69
Trio-Kenwood Communications .....	2, Cover IV
MFJ Enterprises .....	7
MHz Electronics .....	124, 125, 126, 127, 128
Madison Electronics Supply .....	140
Maggiore Electronic Lab .....	44
Memphis Amateur Electronics .....	138
John J. Meshna, Jr., Co., Inc. ....	115
Micro-Mart Distributors .....	133
Micro Systems .....	65
Microwave Filter, Inc. ....	42
Midwest Amateur Radio Supply .....	36
Mirage Communications .....	42
Missouri Radio Center .....	70
Morning Distributing .....	62
Mosley Electronics .....	67, 130, 135
NCG .....	102
W.H. Nail Co. ....	122
Nampa Satellite Systems .....	111
Nemal Electronics .....	65
Nevada Satellite .....	21
Nuts & Volts .....	80
P.C. Electronics .....	34
Pro-Search Electronics .....	75
RF Enterprises .....	123
RF Products .....	86
Radio Amateur Callbook .....	122
Radio Expo .....	65
Ramsey Electronics .....	88
Roensch Microwave .....	130
Sartori Associates .....	86
Satellite TV Magazine .....	110
Spectrum International .....	44
Spectrum West .....	122
Spi-Ro Distributing .....	130
Starfinder .....	13
TE Systems .....	93
TNT Radio Sales .....	65
Tel-tone .....	123
Texas Towers .....	72, 73
UNR Rohn .....	85, 138
Universal Electronics .....	76
University Microfilms International .....	76
VHF Communications .....	85
Vanguard Labs .....	130
Varien/Eimac .....	14
Vector Radio .....	86
Webster Communications .....	67
Westcom Engineering .....	67
Western Electronics .....	56
Williams Radio Sales .....	86
World View Electronics, Inc. ....	11
Yaesu Electronics Corp. ....	Cover III



# ham radio Reader Service

For literature or more information, locate the Reader Service number at the bottom of the ad, circle the appropriate number on this card, affix postage and send to us. We'll hustle your name and address to the companies you're interested in.

101 113 125 137 149 161 173 185 197 209 221 233 245 257 269 281 293 305 317 329 341  
102 114 126 138 150 162 174 186 198 210 222 234 246 258 270 282 294 306 318 330 342  
103 115 127 139 151 163 175 187 199 211 223 235 247 259 271 283 295 307 319 331 343  
104 116 128 140 152 164 176 188 200 212 224 236 248 260 272 284 296 308 320 332 344  
105 117 129 141 153 165 177 189 201 213 225 237 249 261 273 285 297 309 321 333 345  
106 118 130 142 154 166 178 190 202 214 226 238 250 262 274 286 298 310 322 334 346  
107 119 131 143 155 167 179 191 203 215 227 239 251 263 275 287 299 311 323 335 347  
108 120 132 144 156 168 180 192 204 216 228 240 252 264 276 288 300 312 324 336 348  
109 121 133 145 157 169 181 193 205 217 229 241 253 265 277 289 301 313 325 337 349  
110 122 134 146 158 170 182 194 206 218 230 242 254 266 278 290 302 314 326 338 350  
111 123 135 147 159 171 183 195 207 219 231 243 255 267 279 291 303 315 327 339  
112 124 136 148 160 172 184 196 208 220 232 244 256 268 280 292 304 316 328 340

*Limit 15 inquiries per request.*

NAME \_\_\_\_\_ CALL \_\_\_\_\_

ADDRESS \_\_\_\_\_

CITY \_\_\_\_\_ STATE \_\_\_\_\_ ZIP \_\_\_\_\_

Please use before September 30, 1984 August 1984

\_\_\_\_\_  
\_\_\_\_\_  
\_\_\_\_\_

AFFIX POSTAGE  
OR  
POST OFFICE  
WILL NOT  
DELIVER

**ham  
radio**

*magazine*

READER SERVICE CENTER  
P.O. BOX 358  
ARLINGTON, MA 02174

ATTN: Reader Service Dept.

# FM-2033

2m C-MOS MICROPROCESSOR CONTROLLED  
DIGITAL SYNTHESIZER FM TRANSCEIVER

Shown actual size.

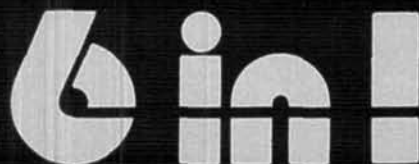

Exclusive KDK 6 in 1 control is now joined by 6 exciting new KDK features:

NEW! % Soft Orange background Liquid Crystal Display (LCD) for direct sunlight viewing plus lighting for night viewing.

NEW! % Offset (+, -, S) stored in memory along with the frequency information.

NEW! % Frequency coverage of 142.000 to 149.995 MHz for M.A.R.S. and C.A.P. usage.

NEW! % Chrome front panel with accent knobs and lighter color on case to match today's auto decor.

NEW! % Scan for signal now has 3-second delay before resume after loss of signal.

NEW! % Repositioned controls for more convenient operation.

The Exclusive KDK 6 in 1 Knob.



• Only memories with data are scanned; blanks are skipped.

• Complete memory back-up with power unplugged. Re-chargeable Ni-Cd with capability of several months back-up of memory.

• Single frequency sub-audible tone generator included as a standard feature.

• Tone unit switch on front panel to prevent "humming" on the wrong channel.

• Repeater input monitor capability with the push of a single momentary switch.

• Solid-state level meter for both output level and input level monitoring.

• User programmable initial characteristics for band limits, channel step size, etc.

• Odd repeater splits can be handled with the memory in the AxB mode.

• Programmable band-scan limits are stored in protected RAM.

• Modular construction with pluggable interconnecting wiring.

• Touch-Tone® microphone TM-2 is standard with each radio.

• Change channels, skip-scan or step up and down the band from TM-2 microphone.

• Audible beep for end-of-band or last memory location for better "eye's off" operation.

The KDK FM-2033 represents a significant advance in user convenience and simplicity of operation for the radio user. The KDK '33' series of transceivers provides excellent readability in any lighting condition for either the operating frequency or the memory channel number in use. The use of a warm orange background for the LCD displays improves the readability by providing an easy on the eyes contrast improvement.

Simplicity of operation has always been the mark of the KDK design team and the FM-2033 is no exception. From the single knob frequency and memory selection to the automatic recall of the desired repeater offset from memo-

ry, the FM-2033 continues to provide relaxed, comfortable mobile operation.

Once the 10 memory frequencies have been selected, a single knob is all that is required for operation on the standard simplex or repeater channels. Using the audible beep as the end of memory marker allows setting to a particular channel without even looking at the radio.

In the scan mode, scanning for a busy memory or pre-programmed band scan keeps you up to date on the happenings in the area. Very busy frequencies can be skipped by using the up key on the TM-2 microphone. If a full 10 memories are not used, the unused ones can be marked for scan skip so that no time is wasted checking them.

The FM-2033 provides a clean 25 watt output signal across 142 - 149.995 MHz to operate in balance with most repeater signals and provide quieting on the simplex operations. M.A.R.S. (NAVY too!) and C.A.P. frequencies are also accommodated.

You want convenience, reliability and easy operation for your mobile station and a tough to beat dollar value. Check out the FM-2033 at your local dealer TODAY or send a QSL for specifications.

\* Touch Tone is a Registered Trade Mark of American Telephone and Telegraph.

Specifications are nominal and are subject to change. All KDK transceivers meet or exceed FCC regulations regarding spurious emissions.



Distributed by  
**Encomm, Inc.**  
2000 Avenue G, Suite 800, Plano, Texas 75074  
Phone (214) 423-0024 TLX 79-4783 ENCOMM DAL

# Take home a world champion.

**\$85\*** gets you a technical knockout.  
**The Fluke 70 Series.**  
**Winners of the digital vs. analog battle.**

Since their debut, they've become the worldwide champions of the industry.

Never before have such tough, American-made meters offered so many professional features at such unbeatable prices.

Each comes with a 3-year warranty, 2,000+ hour battery life, and instant autoranging.

You also get the extra resolution of a 3200-count LCD display, plus a responsive analog bar graph for quick visual checks of continuity, peaking, nulling and trends.

Choose from the Fluke 73, the ultimate in simplicity. The feature-packed Fluke 75. Or the deluxe Fluke 77, with its own protective holster and unique "Touch Hold" function\*\* that captures and holds readings, then beeps to alert you.

So don't settle for just a contender. Take home a world champion.

For your nearest distributor or a free brochure, call toll-free anytime **1-800-227-3800, Ext. 229**. From outside the U.S., call 1-402-496-1350, Ext. 229.

FROM THE WORLD LEADER  
IN DIGITAL MULTIMETERS.



#### FLUKE 73

\$85\*  
Analog/digital display  
Volts, ohms, 10A diode test  
Autorange  
0.7% basic dc accuracy  
2000+ hour battery life  
3-year warranty

#### FLUKE 75

\$99\*  
Analog/digital display  
Volts, ohms, 10A mA diode test  
Audible continuity  
Autorange/range hold  
0.5% basic dc accuracy  
2000+ hour battery life  
3-year warranty

#### FLUKE 77

\$129\*  
Analog/digital display  
Volts, ohms, 10A, mA diode test  
Audible continuity  
"Touch Hold" function  
Autorange/range hold  
0.3% basic dc accuracy  
2000+ hour battery life  
3-year warranty  
Multipurpose holster

\* Suggested U.S. list price, effective July 1, 1984.  
\*\* Patent pending.

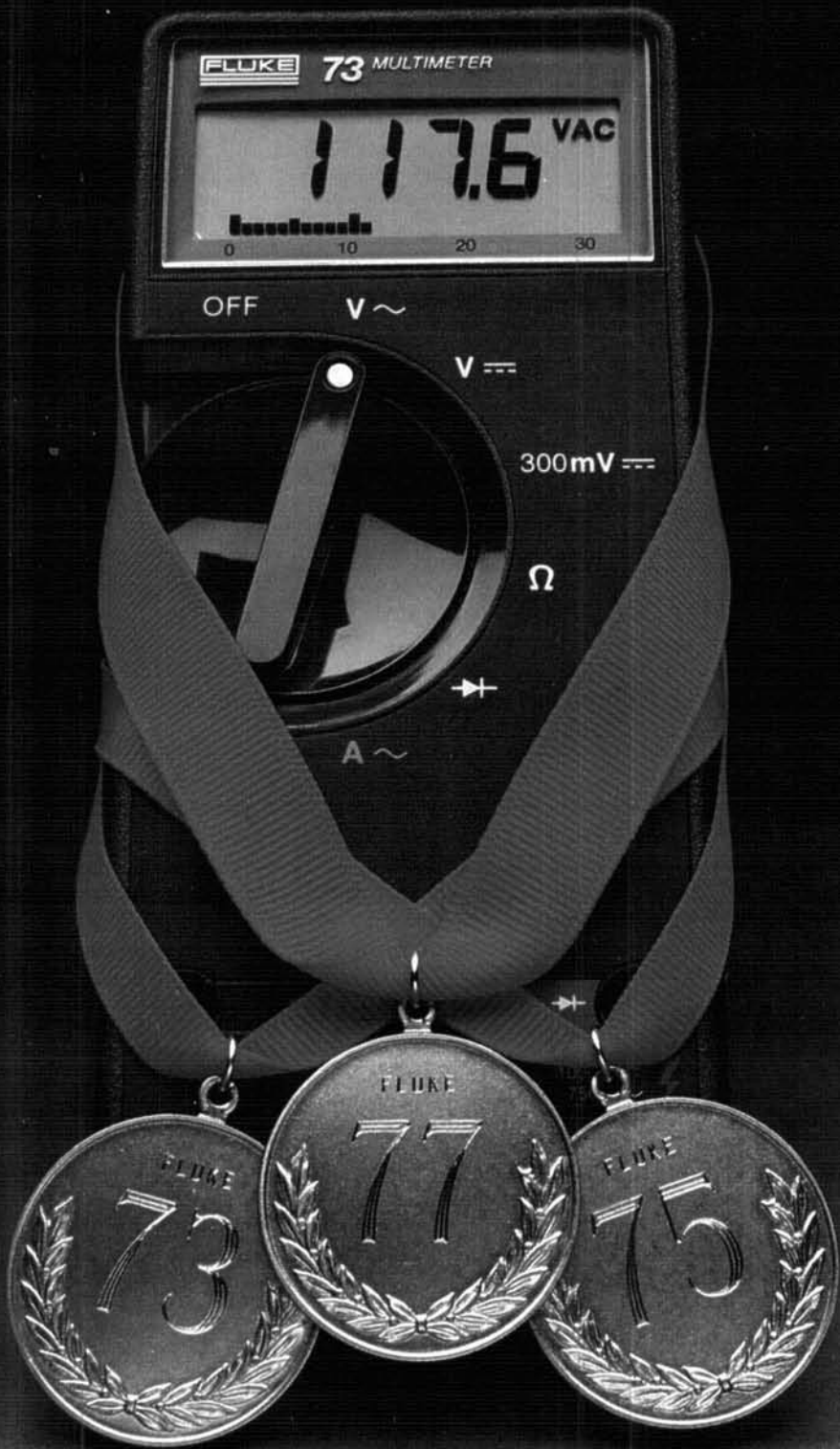

# FT-77 The Rig for All Seasons!

Answering the call for an HF rig that goes everywhere, sounds great, and is cost-effective, Yaesu proudly introduces the FT-77 Compact HF Transceiver System.



## Computerized Design and Manufacture

The FT-77 design engineers utilized the latest computerized circuit board layout methods, resulting in a compact, reliable transceiver with maximum utilization of available space. Automated insertion techniques are used in assembly, providing improved reliability and quality control over earlier designs.

## Operating Versatility

The FT-77 is equipped for operation on all amateur bands between 3.5 and 29.7 MHz, including the three new WARC bands. Fully operational on SSB and CW, the FT-77 includes a dual width noise blanker (designed to minimize the "Woodpecker" or ignition noise), full SWR metering, R.I.T., and optional CW filter with wide/narrow selection. The optional FM-77 permits operation on the FM mode, with front panel squelch sensitivity control.

## Expandable Station Concept

Ideal for mobile operation because of its compact size and light weight, the FT-77 forms the nucleus of a versatile base station. Available as options for the FT-77 are the FP-700 AC Power Supply, FV-700DM Synthesized External VFO and Memory System, FTV-707 VHF/UHF Transverter, and FC-700 Antenna Coupler, providing top performance at an extraordinarily low price.

## Best of All, It's a Yaesu!

With the most experience in transceiver design and manufacture, the Yaesu trademark is your guarantee of quality and durability. We've got all-new technology and an all-new warranty policy to back it up.

See the FT-77 and the all new line of Yaesu HF, VHF, and UHF transceivers, receivers and accessories at your Yaesu Dealer today! *It's time you tried a Yaesu!*

Price And Specifications Subject To  
Change Without Notice Or Obligation

✓ 201

**YAESU**  
*The radio.*



0283R

**YAESU ELECTRONICS CORPORATION** 6851 Walthall Way, Paramount, CA 90723 • (213) 633-4007  
**YAESU CINCINNATI SERVICE CENTER** 9070 Gold Park Drive, Hamilton, OH 45011 • (513) 874-3100



# KENWOOD

...pacesetter in amateur radio

## TR-7950, watts to see!

### TR-7950/7930

The TR-7950/7930 has become the unanimous choice of the 2 meter FM operator! It stands alone in features, performance and reliability, with no other rig even close!

The TR-7950/7930 features a large L.C.D. display that is easy to read in direct sunlight and is back lighted for comfortable night-time viewing. It displays TRANS/REC frequencies, memory channel, repeater offset (+, S, -), sub-tone number (F-0, 1, 2, 3) tone, scan, and memory scan lock-out. It includes an LED S/RF bar meter, and LED indicators for reverse, center TUNING, PRIORITY and ON AIR. The 21 multi-function memory channels store frequency, repeater offset, and optional sub-tone channels. Memories 1 through 15 are for simplex or  $\pm 600$  Hz offset. Memory pairs 16/17 and 18/19 are paired for non-standard repeater offset. Memories "A" and "B" set upper and lower scan limits, or are for simplex or  $\pm 600$  kHz offset. In MEMORY mode, a circle of light appears around the memory selector

knob. When the memory selector knob is rotated in either direction to channel 1, an audible "beep" sounds.

With 45 big watts, the TR-7950 is the most powerful 2 meter FM rig you can buy. The TR-7930 with a modest 25 watts is also available. A HI/LOW power switch allows power reduction to approx. 5 watts.

Other key features include: Programmable band-scan width, Center stop during band-scan, with indicator. Scan stops on busy channel and resume scan is automatic (time 5 sec. adjustable) or carrier operated. A scan delay of approx. 1.5 sec. is built-in. Scanning can also be accomplished with UP/DOWN microphone or "SC" key on front panel. Programmable priority alert can be set into any of 21 memory channels. With Alert switch "ON," a dual "beep" sounds when signal is present. The microprocessor is pre-programmed for simplex or  $\pm 600$  kHz offset in accordance with the 2 meter band plan, with an

"OS" key to allow manual changes in offset. The keyboard functions as a 16-key autopatch encoder during transmit. Frequency coverage is 142.000-148.995 MHz, and it has a repeater reverse switch and mobile mounting bracket. All these features are available in one compact, lightweight rig.

Yes, Kenwood is on top with the TR-7950! Its field proven reliability and matchless performance makes the TR-7950 the rig of tomorrow, today!!

#### TR-7950 optional accessories:

TU-79, three frequency tone unit, KPS-12 fixed-station power supply (7950), KPS-7A fixed-station power supply (7930), SP-40 mobile speaker, SP-50 mobile speaker, MC-55 mobile microphone with time-out timer, MC-46 16-key autopatch UP/DOWN mic, SW-100A/B power meters, PG-3A noise filter.

More information on the TR-7950/7930 is available from authorized dealers of Trio-Kenwood Communications, 1111 West Walnut Street, Compton, CA 90220

*Specifications and prices are subject to change without notice or obligation.*

